



Specific Plan Area No. 1
Amendment No. 1

City of Calimesa

April 18th, 2005
Final Approved Document



at Oak Valley
A Master Planned Community for the City of Calimesa

City of Calimesa
Specific Plan Area No. 1
Amendment No. 1

Prepared for:
SunCal Companies
2392 Morse Avenue
Irvine, CA 92614
(949) 777-4040

Prepared by:
T&B Planning Consultants
17542 East 17th Street, Suite 100
Tustin, CA 92780
(714) 505-6360

In Consultation with:
VanDyke, LLP – *Landscape Architects*
The Keith Companies – *Civil Engineers*
LSA Associates, Inc. – *Environmental*
Urban Crossroads – *Traffic*

April 18, 2005
Final Approved Document

□ TABLE OF CONTENTS

SECTION I – INTRODUCTION I-1

A. DOCUMENT PURPOSE I-1

B. PROJECT BACKGROUND I-1

C. GOALS AND OBJECTIVES I-4

D. PLANNING APPROACH I-5

E. GENERAL PLAN CONSISTENCY I-7

F. COMPARISON TO APPROVED SPECIFIC PLAN AREA NO. 1 I-8

SECTION II – PROJECT SUMMARY..... II-1

A. PROJECT DESCRIPTION II-1

B. EXISTING SITE CHARACTERISTICS II-1

C. SENSITIVE ENVIRONMENTAL RESOURCES II-8

D. EXISTING AND SURROUNDING LAND USE II-13

E. PROJECT SUMMARY II-13

SECTION III – SPECIFIC PLAN..... III-1

A. DEVELOPMENT PLANS AND STANDARDS III-1

1. SPECIFIC PLAN LAND USE PLAN III-1

2. OPEN SPACE AND RECREATION III-11

3. CIRCULATION PLAN III-21

4. DRAINAGE III-27

5. WATER AND SEWER III-30

6. PUBLIC FACILITIES III-35

7. PHASING III-39

8. CONSTRUCTION, MAINTENANCE, AND OWNERSHIP III-39

B. VILLAGE PLANS AND STANDARDS III-43

1. VILLAGE A III-43

2. VILLAGE B III-47

3. VILLAGE C III-52

4. VILLAGE D III-56

5. VILLAGE E III-61

6. TOWN CENTER III-65

SECTION IV – DESIGN GUIDELINES IV-1

A. PURPOSE AND INTENT IV-1

B.	INTRODUCTION.....	IV-2
C.	ARCHITECTURAL DESIGN GUIDELINES	IV-3
1.	RESIDENTIAL CRITERIA	IV-3
2.	ARCHITECTURAL THEME	IV-3
3.	SITE PLANNING CHARACTERISTICS.....	IV-4
4.	ARCHITECTURAL STYLES	IV-15
5.	BUILDING MASS AND SCALE	IV-27
6.	BUILDING MATERIALS AND COLORS	IV-28
7.	WINDOWS AND DOORS	IV-31
8.	PORCHES AND BALCONIES	IV-31
9.	COLUMNS AND POSTS	IV-34
10.	GARAGES.....	IV-34
11.	REAR AND SIDE YARD ARTICULATION	IV-38
12.	ROOF MATERIALS AND COLORS	IV-41
13.	ACCESSORY STRUCTURES	IV-41
14.	MAILBOXES.....	IV-41
15.	COMMERCIAL SITE PLAN	IV-43
16.	BUSINESS PARK SITE PLAN.....	IV-43
17.	TYPICAL COMMERCIAL AND BUSINESS PARK ARCHITECTURAL STYLE	IV-43
18.	COMMERCIAL AND BUSINESS PARK DESIGN CRITERIA	IV-43
19.	COMMERCIAL SITE PLANNING CONCEPTS.....	IV-50
D.	COMMUNITY ELEMENTS	IV-56
1.	COMMUNITY DESIGN THEME	IV-56
2.	COMMUNITY ENTRY MONUMENTATION.....	IV-56
3.	TRAIL MONUMENTATION.....	IV-66
E.	STREET LANDSCAPING	IV-68
1.	STREETSCAPES	IV-68
2.	LANDSCAPE INTERFACES	IV-76
3.	COMMUNITY WALLS AND FENCES	IV-89
4.	COMMUNITY AMENITIES.....	IV-89
5.	TRAILS AND SIDEWALKS	IV-109
F.	LANDSCAPE DESIGN GUIDELINES	IV-119
1.	GENERAL LANDSCAPE DESIGN ISSUES.....	IV-119
2.	OUTDOOR LIGHTING	IV-119
3.	SIGNAGE.....	IV-119
4.	MAILBOXES.....	IV-119
5.	IRRIGATION	IV-120
6.	EROSION CONTROL	IV-120
7.	MAINTENANCE RESPONSIBILITY	IV-121
8.	FUEL MODIFICATION	IV-121

9. GENERAL LANDSCAPE REQUIREMENTSIV-125

SECTION V – SUMMERWIND RANCH ZONING ORDINANCE V-1

SECTION VI – HILLSIDE DEVELOPMENT REGULATIONS VI-1

 A. PURPOSE AND INTENTVI-1

 B. DEFINITIONSVI-1

 C. POLICIES.....VI-4

 D. HILLSIDE CLASSIFICATIONS.....VI-4

 E. RIDGELINE PRESERVATIONVI-5

 F. DESIGN CRITERIA.....VI-6

 G. GRADINGVI-7

 H. RETAINING WALLS & FENCESVI-8

 I. ARCHITECTURAL STANDARDSVI-9

 J. DRAINAGEVI-9

 K. APPLICATION SUBMITTALVI-10

 L. ACTION OF PLANNING DIRECTOR IMPLEMENTING DEVELOPMENTVI-10

 M. ACTION OF COMMISSION IMPLEMENTING DEVELOPMENTVI-11

 N. ISSUANCE OF GRADING PERMIT.....VI-11

SECTION VII –OAK TREE PROTECTION PLAN VII-1

 A. PURPOSE VII-1

 B. APPLICABILITY VII-1

SECTION VIII– GENERAL PLAN CONSISTENCY ANALYSIS..... VIII-1

□ LIST OF FIGURES

I-1 Adopted Land Use - Oak Valley Area I-2
 I-2 Specific Plan Area No. 1, Amendment No. 1 Boundary I-3
 I-3 Specific Plan Land Use Plan I-10
 I-4 Specific Plan Area No. 1 Land Uses vs. Amendment No. 1 Land Uses..... I-12
 I-5 Specific Plan Area No. 1 vs. Amendment No. 1 Overlay Comparison..... I-13

II-1 Regional Map II-2
 II-2 Vicinity Map II-3
 II-3 Aerial Photograph II-4
 II-4 Topographic Map II-5
 II-5 Sensitive Environmental Areas Map II-9
 II-6 Approved Plan with Sensitive Environmental Areas Overlay II-11
 II-7 Proposed Plan with Sensitive Environmental Areas Overlay II-12
 II-8 Existing and Surrounding Land Uses..... II-14

III-1 Specific Plan Land Use Plan III-2
 III-2 Open Space and Recreation Plan III-13
 III-3 Active Park Concept III-15
 III-4 Passive Park Concept..... III-16
 III-5 Linear Park Concept..... III-17
 III-6 Nature Park Concept..... III-19
 III-7 Community Recreation Center Concept..... III-20
 III-8 Circulation Plan..... III-22
 III-9 Roadway Cross-Sections III-23
 III-10 Trails System Plan III-26
 III-11 Master Drainage Plan III-28
 III-12 Master Water Plan..... III-31
 III-13 Master Sewer Plan III-33
 III-14 Public Facilities III-36
 III-15 Development Phasing Plan..... III-40
 III-16 Village A..... III-44
 III-17 Village B III-50
 III-18 Village C III-54
 III-19 Village D..... III-59
 III-20 Village E..... III-63
 III-21 Town Center..... III-67

IV-1 Clustered Development ConceptIV-5
 IV-2 Residential Site Plan Concept – Manors and Villas (3-4 DU/AC)IV-8
 IV-3 Residential Site Plan Concept – Cottages and Bungalows (5-6 DU/AC) .IV-10

IV-4	Garden Court Site Plan Concept.....	IV-12
IV-5	Townhomes Site Plan Concept	IV-16
IV-6	Typical Architectural Style #1 – Craftsman Bungalow	IV-20
IV-7	Typical Architectural Style #2 – American Farmhouse	IV-21
IV-8	Typical Architectural Style #3 – California Ranch	IV-23
IV-9	Typical Architectural Style #4 – Prairie	IV-24
IV-10	Typical Architectural Style #5 – Monterey	IV-26
IV-11	Typical Architectural Style #6 – French Country	IV-28
IV-12	Building Mass & Scale.....	IV-31
IV-13	Building Materials & Color	IV-32
IV-14	Windows & Doors	IV-34
IV-15	Porches & Balconies.....	IV-35
IV-16	Columns & Posts	IV-37
IV-17	Garages	IV-39
IV-18	Rear and Side Articulation.....	IV-42
IV-19	Roof Materials & Colors	IV-44
IV-20	Commercial Site Plan Concept	IV-46
IV-21	Business Park Site Plan Concept	IV-47
IV-22	Typical Commercial Architectural Style	IV-48
IV-23	Typical Business Park Architectural Style.....	IV-49
IV-24	Commercial Monumentation – Option 1.....	IV-56
IV-25	Commercial Monumentation – Option 2.....	IV-57
IV-26	Key to Monumentation, Streetscapes & Edge Conditions.....	IV-59
IV-27	Major Community Entry Monumentation	IV-61
IV-28	Minor Community Entry Monumentation	IV-62
IV-29	Neighborhood Entry Monumentation – Option 1	IV-63
IV-30	Neighborhood Entry Monumentation – Option 2	IV-64
IV-31	Special Feature Monumentation	IV-65
IV-32	School Monumentation.....	IV-66
IV-33	Park Monumentation	IV-67
IV-34	Trail Monumentation.....	IV-69
IV-35	Singleton Road Streetscape – Secondary Highway Portion	IV-71
IV-36	Singleton Road Streetscape – Arterial Highway Portion	IV-72
IV-37	Roberts Road Streetscape	IV-73
IV-38	Major Road Streetscape.....	IV-74
IV-39	Divided Collector Road Streetscape.....	IV-75
IV-40	Modified Secondary Road Streetscape	IV-76
IV-41	Urban Arterial Highway Streetscape.....	IV-77
IV-42	Edge Condition – Residential/Natural Open Space	IV-80
IV-43	Edge Condition – Residential/Riparian Corridor.....	IV-81
IV-44	Edge Condition – Residential/Recreation.....	IV-82
IV-45	Edge Condition – Residential/Passive Park	IV-83
IV-46	Edge Condition – Residential/Linear Park	IV-84

IV-47	Edge Condition – Residential/School, School/Park, and Park/Open Space.....	IV-85
IV-48	Edge Condition - Sideyard.....	IV-86
IV-49	Edge Condition – Commercial/I-10 Freeway.....	IV-87
IV-50	Edge Condition – Residential/I-10 Freeway	IV-88
IV-51	Edge Condition – Residential/Commercial	IV-89
IV-52	Wall & Fence Plan	IV-91
IV-53	Wall & Fence Details - A.....	IV-92
IV-54	Wall & Fence Details - B	IV-93
IV-55	Parks and Open Space Concept Plan	IV-94
IV-56	Conceptual Active Park Illustration - A	IV-95
IV-57	Conceptual Active Park Illustration - B.....	IV-96
IV-58	Conceptual Active Park Illustration - C.....	IV-97
IV-59	Conceptual Active Park Illustration - D	IV-98
IV-59a	Conceptual Active Park Illustration - E	IV-98a
IV-60	Nature Park	IV-99
IV-61	Passive Park – Phase 2	IV-101
IV-62	Linear Park - Concept	IV-102
IV-63	Linear Park – Pocket 1	IV-103
IV-64	Linear Park – Pocket 2	IV-104
IV-65	Linear Park – Pocket 3	IV-105
IV-66	Linear Park – Phase 3 Concept.....	IV-106
IV-67	Linear Park – Passive	IV-107
IV-68	Trail and Sidewalk Plan.....	IV-109
IV-69	Trail and Sidewalk Cross Sections.....	IV-110
IV-70	Combined Roadway/Trail Interface Cross Section Key Map	IV-111
IV-71	Combined Roadway/Trail Interface Cross Sections A, B, C, & D	IV-112
IV-72	Combined Roadway/Trail Interface Cross Sections E, F, G, & H.....	IV-113
IV-73	Pedestrian Trail Overlook	IV-114
IV-74	Pedestrian Bridge.....	IV-115
IV-75	Equestrian Trail Section	IV-116
IV-76	Fuel Modification Zones	IV-120
IV-77	Fuel Modification Areas	IV-122
IV-78	Street Trees Master Plan	IV-124
VI-1	Sensitive Environmental Areas Map	VI-12
VI-2	Slope Map.....	VI-13
VI-3	Contour Grading Concept.....	VI-14

□ LIST OF TABLES

I-1 Specific Plan Area No. 1 vs. Amendment No. 1 Land Use Comparison..... I-15

II-1 General Land Use Statistical Summary..... II-16

III-1 Detailed Land Use Summary III-3

III-2 Roadway Standards III-24

III-3 Construction, Ownership, Maintenance Responsibilities III-41

III-4 Village A Planning Area Summary III-45

III-5 Village B Planning Area Summary..... III-51

III-6 Village C Planning Area Summary III-55

III-7 Village D Planning Area Summary III-60

III-8 Village E Planning Area Summary..... III-64

III-9 Town Center III-68

IV-1 Manors and Villas Residential Development Standards.....IV-7

IV-2 Cottages and Bungalows Residential Development Standards.....IV-9

IV-3 Garden Courts Residential Development StandardsIV-11

IV-4 Townhomes Residential Development StandardsIV-14

V-1 Specific Plan Area No. 1, Amendment No. 1 - Residential Development Standards..... V-1

□ LIST OF CHARTS

I-1 Land Use Acreage Comparison..... I-14

I. INTRODUCTION

A. Document Purpose

This Specific Plan Amendment (SPA) has been prepared for the purpose of establishing guidelines for a master Planned Community known as SUMMERWIND RANCH AT OAK VALLEY. A specific plan is defined by government code as a tool for the systematic implementation of the general plan for all or part of the area covered by the general plan. It effectively establishes a link between implementing policies of the general plan and the individual development proposals in a defined area. To an extent, the range of issues that is contained in a specific plan is left to the discretion of the decision-making body. However, all specific plans, whether prepared by a general law city or county, must comply with §65450 - 65457 of the Government Code. These provisions require that a specific plan be consistent with the adopted general plan of the jurisdiction within which it is located. In turn, all subsequent subdivision and parcel maps, all development, all public works projects, and zoning ordinances within an area covered by a specific plan must be consistent with the specific plan.

B. Project Background

SUMMERWIND RANCH AT OAK VALLEY is the result of many years of planning and refinement. Beginning in the late 1980's, the Oak Valley Specific Plan was approved and Environmental Impact Reports were certified for over 6,000 acres of land located within the communities of Calimesa and Beaumont. On October 6, 1988, Oak Valley Specific Plan 216 and Environmental Impact Report No. 229 were approved and certified by the Riverside County Board of Supervisors. Oak Valley Specific Plan Amendment 216A was approved by the Board of Supervisors on May 22, 1990, which resulted in an approval to develop 6,405 acres within the communities of Calimesa and Beaumont. The existing approved development included single-family and multi-family residential dwelling units, commercial, recreational and community uses, and related infrastructure to be implemented over a 30-year period. Subsequent to approval of Oak Valley Specific Plan 216 and 216A, the City of Beaumont annexed a portion of the Specific Plan area east of Interstate 10 into the City. The City of Calimesa was incorporated in December 1990 and subsequently adopted those portions of Specific Plan 216 and 216A and its accompanying Environmental Impact Report that were situated within the newly incorporated City limits, and renamed the Specific Plan to "Oak Valley SP1" (See Figure I-1, Adopted Land Use-Oak Valley Area). The approved Specific Plan is referred to as Specific Plan Area No. 1 throughout this document. Subsequent to the adoption of Oak Valley SP1 by the City of Calimesa, an opportunity to purchase additional lands for open space uses was provided. The Riverside Land Conservancy purchased 357.8 acres of Oak Valley SP1 with an option for the conversion of an additional 578.7 acres for open space. This proposed Specific Plan Amendment is being processed in order to reflect the change in land uses resulting from the purchase of the 358 acres by the Conservancy and future changes that may result should the option be exercised to convert the additional 578.7 acres for open space uses.

This first amendment to Specific Plan Area No. 1 affects 2,590.7 acres of the Specific Plan Area No. 1 area, as depicted in Figure I-2, *Specific Plan Area No. 1 Amendment No. 1 Boundary*. The area affected by this first amendment to Specific Plan Area No. 1, and its associated land use plan, is referred to as SUMMERWIND RANCH AT OAK VALLEY throughout this document.

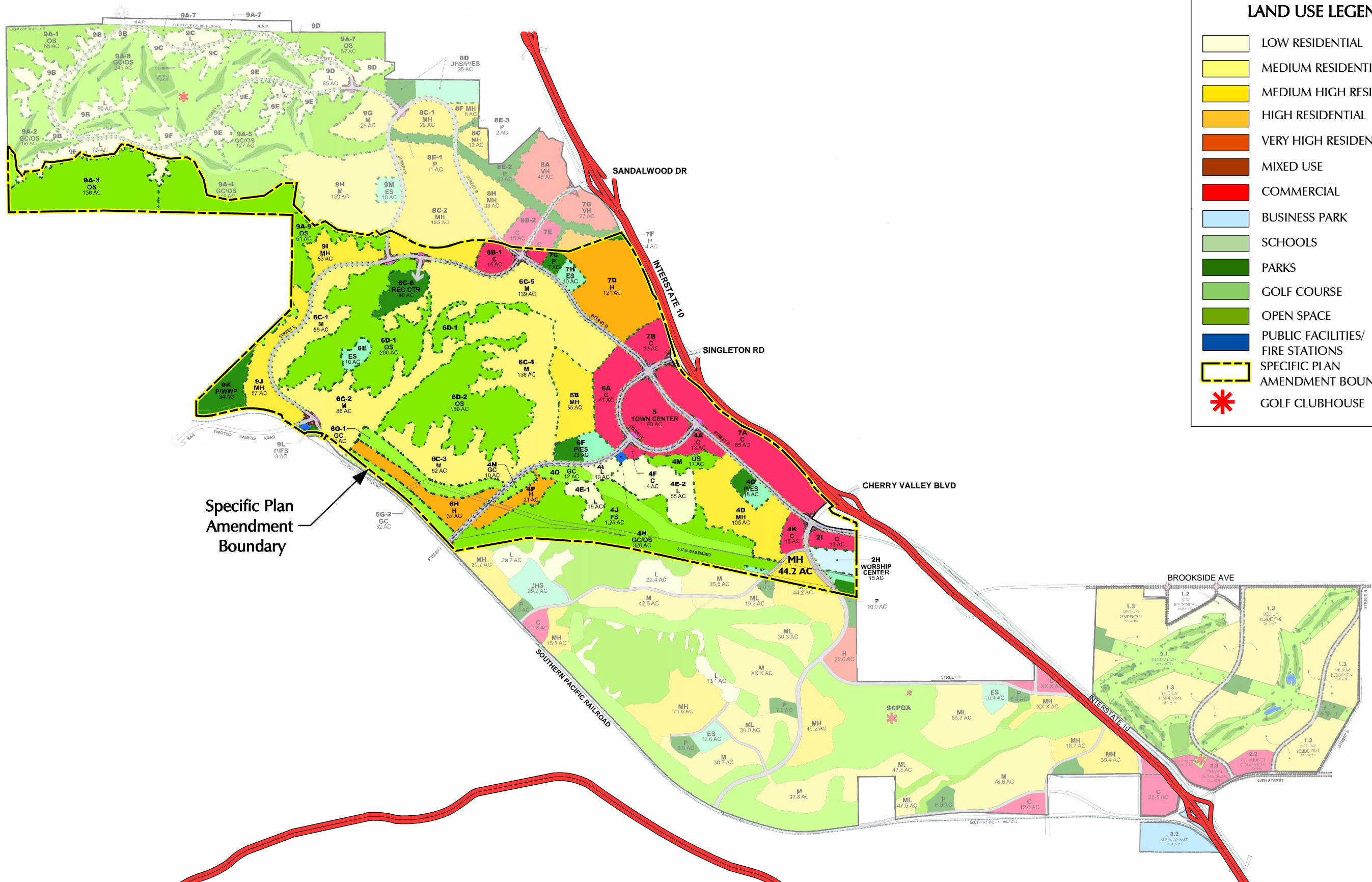

LAND USE LEGEND

	LOW RESIDENTIAL
	MEDIUM RESIDENTIAL
	MEDIUM HIGH RESIDENTIAL
	HIGH RESIDENTIAL
	VERY HIGH RESIDENTIAL
	MIXED USE
	COMMERCIAL
	BUSINESS PARK
	SCHOOLS
	PARKS
	GOLF COURSE
	OPEN SPACE
	PUBLIC FACILITIES/ FIRE STATIONS
	SPECIFIC PLAN AMENDMENT BOUNDARY
	GOLF CLUBHOUSE

Specific Plan
Amendment
Boundary

DATE: 12/10/04

SUMMERWIND RANCH AT OAK VALLEY

Specific Plan Area No. 1,
Amendment No. 1

T&B PLANNING CONSULTANTS
12012 East 12th Street, Suite 100, Santa Ana, CA 92705
P: 714.308.4300 F: 714.308.4381
www.tbplanning.com

FIGURE I-1
ADOPTED LAND USE - OAK VALLEY AREA

LAND USE LEGEND	
	LOW RESIDENTIAL
	MEDIUM RESIDENTIAL
	MEDIUM HIGH RESIDENTIAL
	HIGH RESIDENTIAL
	VERY HIGH RESIDENTIAL
	MIXED USE
	COMMERCIAL
	SCHOOLS
	PARKS
	GOLF COURSE
	OPEN SPACE
	PUBLIC FACILITIES/ FIRE STATIONS
	SPECIFIC PLAN AMENDMENT BOUNDARY

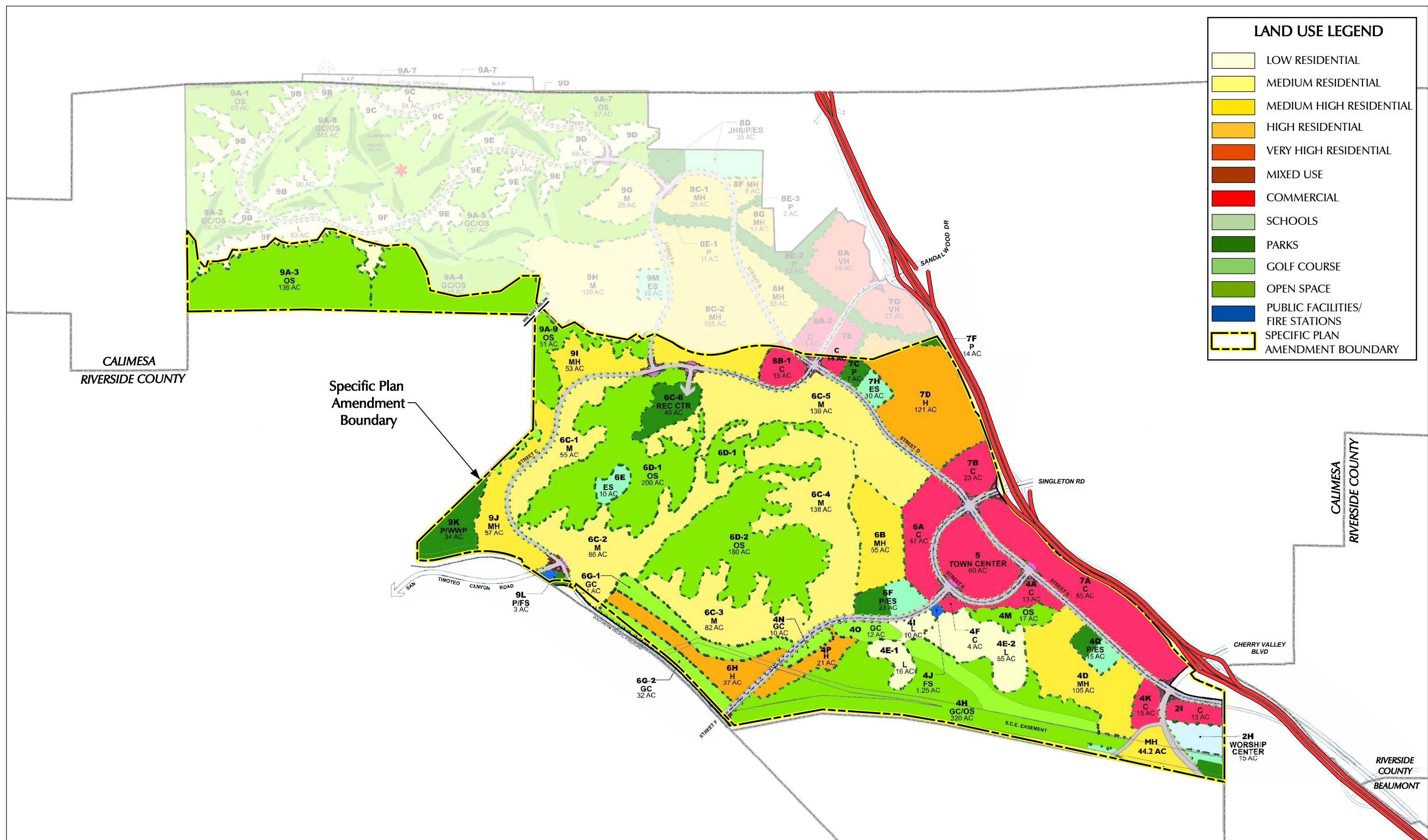

SUMMERWIND RANCH AT OAK VALLEY

Specific Plan Area No. 1,
Amendment No. 1



FIGURE I-2
SPECIFIC PLAN AREA NO. 1, AMENDMENT NO. 1 BOUNDARY

C. Goals and Objectives

The proposed land use plan delineates uses which are intended to meet the needs of the SUMMERWIND RANCH AT OAK VALLEY community and incorporate the City of Calimesa vision. This plan is divided into the following sections: project summary, specific plan (development plans and standards, and village plans and standards), design guidelines, zoning ordinance, hillside development regulations, oak tree protection plan, and general plan consistency analysis.

This SPA is the result of the City of Calimesa General Plan being thoroughly examined and considered during the preparation of the SUMMERWIND RANCH AT OAK VALLEY community. As denoted in the General Plan, the City of Calimesa Planning vision and process is sensitive to environmental protection needs, engineering feasibility, market acceptance, economic viability, development phasing, adjacent land uses and local community goals. In order to ensure the functional integrity, economic viability, environmental sensitivity, and positive aesthetic contribution of this amendment, definitive planning and development goals for the project were established and supported by an extensive analysis process. With these specific project goals in mind, the following objectives have been established for SUMMERWIND RANCH AT OAK VALLEY:

- ❑ Create a **diverse community** with integrated land uses that will result in a balanced, full service, land use plan for a community where people can live, work, shop, secure services, and recreate.
- ❑ **Cluster** neighborhoods and utilize compact building designs within residential and recreational land use mixes to preserve natural open space.
- ❑ Identify and preserve **sensitive environmental resources**, including ridgelines, drainage courses, wildlife corridors, and oak trees.
- ❑ Maintain the integrity of the natural environment through the **preservation and conservation** of open space allowing for connectivity through preservation of viable wildlife corridors and systematic, sensitive planning.
- ❑ Reduce development impacts in hillside areas and ensure that SUMMERWIND RANCH AT OAK VALLEY is developed in an **environmentally sensitive manner**. Hillside development standards shall minimize the alteration, reduction, and removal of the natural setting, thereby creating a more desirable living environment.
- ❑ Create a well-connected **walkable community** with an integrated multi-purpose trail system that will allow residents access to a range of recreational uses.
- ❑ Establish an **interconnected open space system** which provides for diverse trail systems, recreational opportunities, and preservation of open space, sensitive habitat areas, and drainage systems.

- ❑ Locate commercial, retail service, and employment opportunities in response to market conditions and in harmony with the uses of surrounding neighborhoods in an effort to promote a **jobs-housing balance**.
- ❑ Develop land use patterns that shorten travel distances for essential services, limit air and noise pollution, allow for **alternative modes of transportation**, and generally conserve energy.
- ❑ Foster a distinctive, attractive and cohesive community with a **strong sense of place** by integrating community values and natural features within the site.
- ❑ Create a **range of housing opportunities** and choices by diversifying the residential product mix within all of the planning areas of SUMMERWIND RANCH AT OAK VALLEY.
- ❑ **Phase development** so as to ensure adequate levels of services for the project.

D. Planning Approach

The planning approach established to create SUMMERWIND RANCH AT OAK VALLEY utilizes an integrated multi-disciplinary approach. The team assembled to undertake this project includes environmental resource specialists, land planners, landscape architects, civil engineers, water resource specialists, economists, and real estate market analysts. The team created a comprehensive development plan for the 2,590.7 acres that is financially feasible, sensitive to the environment, and compatible with the City of Calimesa General Plan and its vision for the area. These efforts will result in the creation of a master-planned community which fulfills residential, commercial, business, employment, public service, and recreational needs.

In an effort to determine areas most suitable for preservation, the project team utilized a series of map overlays, each displaying unique opportunities and constraints. The following is a list of overlays used:

- Aerial Photography
- Adjacent Land Uses (existing and proposed)
- Riverside Land Conservancy acquisitions (acquired and option lands)
- Topography (slopes, high points, low points, ridges and valleys)
- Biology (plants and animals)
- Hydrology (drainages, surface water, groundwater, floodplains, and wetlands)
- Geology (physiographic, surficial geology, and geomorphology)
- Soils (hydrologic, hydric, erodibility and suitability)
- Existing Circulation (roadways, freeways, and interchanges)
- Existing Trails (on and off-site)
- Potential Wildlife Corridors (including Garden Air Wash)
- Significant ridgelines, drainages and valleys

As each overlay was superimposed upon one another, the areas available for preservation became more clearly defined. As a result, over 1,460 acres or 56% of SUMMERWIND RANCH AT OAK VALLEY are hereby proposed to remain as natural open space.

While the map overlay process aided the team in defining the areas suitable for preservation, it also assisted in determining areas suitable for development. With the natural open space system defined and a development envelope in place, the project team designed an integrated roadway system to accommodate needs of the SUMMERWIND RANCH AT OAK VALLEY community and integrate with the City of Calimesa's existing transportation system.

The design team then focused on the location of community amenities. Park and school sites were located throughout the community and located near major project roadways and, in many cases, adjacent to prominent natural open space areas. Park sites within SUMMERWIND RANCH AT OAK VALLEY will consist of a mix of active, passive, linear, and nature park uses. Two elementary schools and one middle school are planned which will be designed with joint-use recreational areas that will integrate with the community's parks.

Residential village and neighborhood areas were then formed on the basis of logical, phased units of development. Village boundaries were generally defined by the site's natural open space areas, the internal circulation system, and the SPA boundary. Each of the five villages are planned to consist of a variety of residential neighborhoods, parks, schools, and natural open space areas. Individual neighborhoods will consist of a single housing type and are generally defined by open space amenities and project roadways.

The Town Center will be located on 320.8 acres adjacent to the Interstate 10 (I-10 corridor). The Town Center will consist of a well-integrated mix of commercial, business park, and public facility land uses. Civic uses such as a fire station, civic center, library, and police station may also be incorporated into the Town Center at SUMMERWIND RANCH AT OAK VALLEY. The Town Center is centrally located within the site in an effort to promote convenient pedestrian and automobile accessibility, while also contributing to the local jobs/housing balance.

The final element of the design process involved the design of a multi-purpose trail system, created to promote multi-modal connectivity throughout the community. The trail system integrates existing trails on the site and trail connections off site, as well as a variety of future trail systems to be built in conjunction with SUMMERWIND RANCH AT OAK VALLEY.

The resulting SUMMERWIND RANCH AT OAK VALLEY land use plan demonstrates the concept of clustering residential land uses. Clustering is a planning technique that focuses on the preservation of natural open space, while grouping residential neighborhoods in harmony with the natural features that surround it. Clustered residential communities greatly respect the uniqueness of the area where they are built, while also minimizing the disturbance of the site. This technique results in a diverse community that enhances opportunities for preservation, recreation, scenic corridors, and housing variety.

E. General Plan Consistency

The City of Calimesa General Plan was used as a reference document throughout the planning and design stages of SUMMERWIND RANCH AT OAK VALLEY; therefore, this Specific Plan Amendment remains consistent with the City of Calimesa's General Plan. Listed below is a brief summary of the manner in which SUMMERWIND RANCH AT OAK VALLEY will adhere to and remain sensitive to the seven elements set forth in City of Calimesa General Plan. For further and specific analysis, please see Section VIII *General Plan Consistency Analysis*, for a comprehensive list of the City of Calimesa General Plan goals and consequent SPA consistencies.

1. Land Use Element

SUMMERWIND RANCH AT OAK VALLEY will provide the following land uses within the 2,590.7 acres: residential, commercial, open space and recreational facilities, and public facilities, including roadways and public infrastructure. The proposed residential community will be enhanced by providing over 1,400 acres of parks, natural open space, and trails interspersed among the neighborhoods. Commercial centers and business parks will be conveniently located at circulation nodes adjacent to Interstate 10 (I-10). SUMMERWIND RANCH AT OAK VALLEY will also provide school sites, a water reclamation facility, and potential sites for government services, such as a fire station, police station, civic center, and library.

2. Circulation Element

SUMMERWIND RANCH AT OAK VALLEY is consistent with the Transportation Element of the General Plan. All roadways shall be constructed in accordance with the City's standard street classifications. The street system is designed to ultimately serve the SPA area, as well as prevent impacts on other areas of the City of Calimesa at project buildout. The General Plan seeks to establish an area-wide system of equestrian, hiking, and biking trails with linkages to parks and trail systems throughout the area. SUMMERWIND RANCH AT OAK VALLEY adheres and improves on the General Plan by providing a comprehensive, multi-purpose trail system that connects residential neighborhoods to parks, schools, open space, and the Town Center while also providing a linkage to a variety of off-site trails.

3. Housing Element

The General Plan encourages the development and variety of housing to meet the City of Calimesa's responsibilities to the regional housing needs. SUMMERWIND RANCH AT OAK VALLEY provides for a maximum of 3,841 dwelling units built in a variety of housing types ranging in density from 3.0 dwelling units per acre (single-family manors) to 15.0 dwelling units per acre (multi-family townhomes). Residential villages are designed with sensitivity to the topography and natural environment of its surroundings.

4. Resource Management Element

SUMMERWIND RANCH AT OAK VALLEY provides a comprehensive system of managed open space for the purpose of preservation, conservation, and recreation. The General Plan emphasizes the

following Resource Element components: conservation of natural resources; the provision of open space, and the provision of parks and recreational facilities. All aspects of the planning and implementation processes of the SPA were carefully considered in relationship to these Resource Element components. As mentioned in the General Plan and adhered to in this SPA, through the preservation of over 1,400 acres of open space land, SUMMERWIND RANCH AT OAK VALLEY will conserve and protect surface water, groundwater and imported water sources, conserve and protect significant landforms and hillside areas, conserve and protect significant stands of mature trees, native vegetation, and wildlife habitat, all of which will provide a network of open space areas for the preservation of natural resources while providing visual and physical relief from urban development.

5. Safety Element

SUMMERWIND RANCH AT OAK VALLEY is designed so that development is not placed in geologically hazardous areas. Project grading will strive to avoid major streambed areas and channel protection measures will be constructed in open areas as needed. In addition, fire hazards will be minimized with implementation of proposed fuel modification on the landscaping plans for SUMMERWIND RANCH AT OAK VALLEY.

6. Noise Element

SUMMERWIND RANCH AT OAK VALLEY is sensitively designed among the natural topography of the site which in turn lessens acoustical impacts on the residents of the community. In addition, this SPA will adhere to City of Calimesa noise ordinances defined in the EIR for this project. The acoustical impact analysis provides measures which will be implemented to mitigate noise impacts, primarily from traffic on surrounding roadways/highways.

7. Air Quality Element

This SPA will adhere to the South Coast Air Quality Management Plan (SCAQMD) and will implement mitigation measures defined in the EIR for this project. SUMMERWIND RANCH AT OAK VALLEY provides a community that is pedestrian friendly by providing numerous trails throughout the project. In addition, schools, parks, a recreation center, and commercial and governmental services are conveniently located within the project boundaries, reducing vehicle miles traveled within the community.

F. Comparison to Approved Specific Plan Area No. 1

California state law specifically states that a specific plan may not be adopted or amended unless the proposed plan or amendment is consistent with the general plan. Furthermore, the law requires that any specific plan of a city or county that is applicable to the same areas or matters affected by a general plan amendment shall be reviewed and amended as necessary to make the specific plan consistent with the general plan. This Specific Plan Amendment has been prepared in accordance with the City of Calimesa General Plan.

Amendment No. 1 seeks to revise: (1) the distribution, extent, and/or residential density; (2) amount, type, and distribution of non-residential land (commercial, business park, schools, and public

facilities); (3) the amount and distribution of parks and open space; and (4) the alignment of the internal roadway network within Specific Plan No. 1. The proposed land use and circulation changes as shown in Figure I-3, *Specific Plan Land Use Plan*, are in response to: (1) Riverside Land Conservancy's (RLC) property acquisition of portions of Specific Plan Area No. 1 for open space and conservation; (2) preservation of the Garden Air Wash wildlife corridor; (3) preservation of sensitive environmental areas; (4) maintaining the connectivity of existing trail systems to the proposed trails within the project; (5) and updated environmental studies.

As previously mentioned, a significant portion of the Specific Plan Amendment area has been acquired by, or has been optioned to be acquired by The Riverside Land Conservancy (RLC). This is an organization of volunteers and donors that acquire and conserve important open space, wildlife habitat, and prime agricultural lands in Southern California. RLC is a non-profit land trust that facilitates the transfer of land from willing private landowners to public ownership.

Specific Plan Area No. 1, Amendment No. 1 seeks to revise the distribution, extent, and/or residential density. Amendment No. 1 decreases the amount of residential land use from 5,992 dwelling units on 1,066.2 acres, at a density of 5.6 du/ac, to 3,683 dwelling units on 677.0 acres, resulting in a land use density of 5.4 du/ac. Through the preservation of open space and by utilizing the concept of clustering, this SPA decreases the amount of land used for residential use by 389.2 acres, resulting in a decrease of approximately 36.5% of land used for residential development in this Specific Plan. Amendment No. 1 also reduces the number of planned residential units by 38%. SUMMERWIND RANCH AT OAK VALLEY provides for a broader spectrum of residential uses, providing six density categories compared to only four in the approved plan.

This SPA seeks to revise the amount, type, and distribution of non-residential land uses (commercial, business park, schools, and public facilities). Specific Plan Area No. 1 consisted of 371.2 acres of non-residential land use. These non-residential land uses consisted of commercial land use; a fire station; four elementary schools; a worship center; and a wastewater treatment plant. Amendment No. 1 decreases the amount of land used for non-residential land use by 55.7 acres by reducing commercial uses, adding business park uses, eliminating two elementary schools, adding a middle school, and eliminating the worship center. In addition, the Town Center is planned to accommodate a fire station, police station, civic center, and/or a library, should the City desire to construct such facilities. Amendment No. 1 also provides for a separate water reclamation facility, whereas the approved plan's facility is shared with a park site.

Amendment No. 1 seeks to revise the amount and distribution of parks and open space. Specific Plan Area No. 1 proposed a mix of parks, recreation facilities, a potential extension of a 36-hole golf course, a recreation center, and natural open space on approximately 1,046.8 acres. Amendment No. 1 provides 1,493.1 acres of open space and recreation, resulting in an increase of 30% or 446.3 acres of total open space uses. SUMMERWIND RANCH AT OAK VALLEY will contain active, passive, and linear parks; a nature park; a community recreation facility; and natural open space all sensitively designed and connected with residential neighborhoods, schools, and the Town Center.

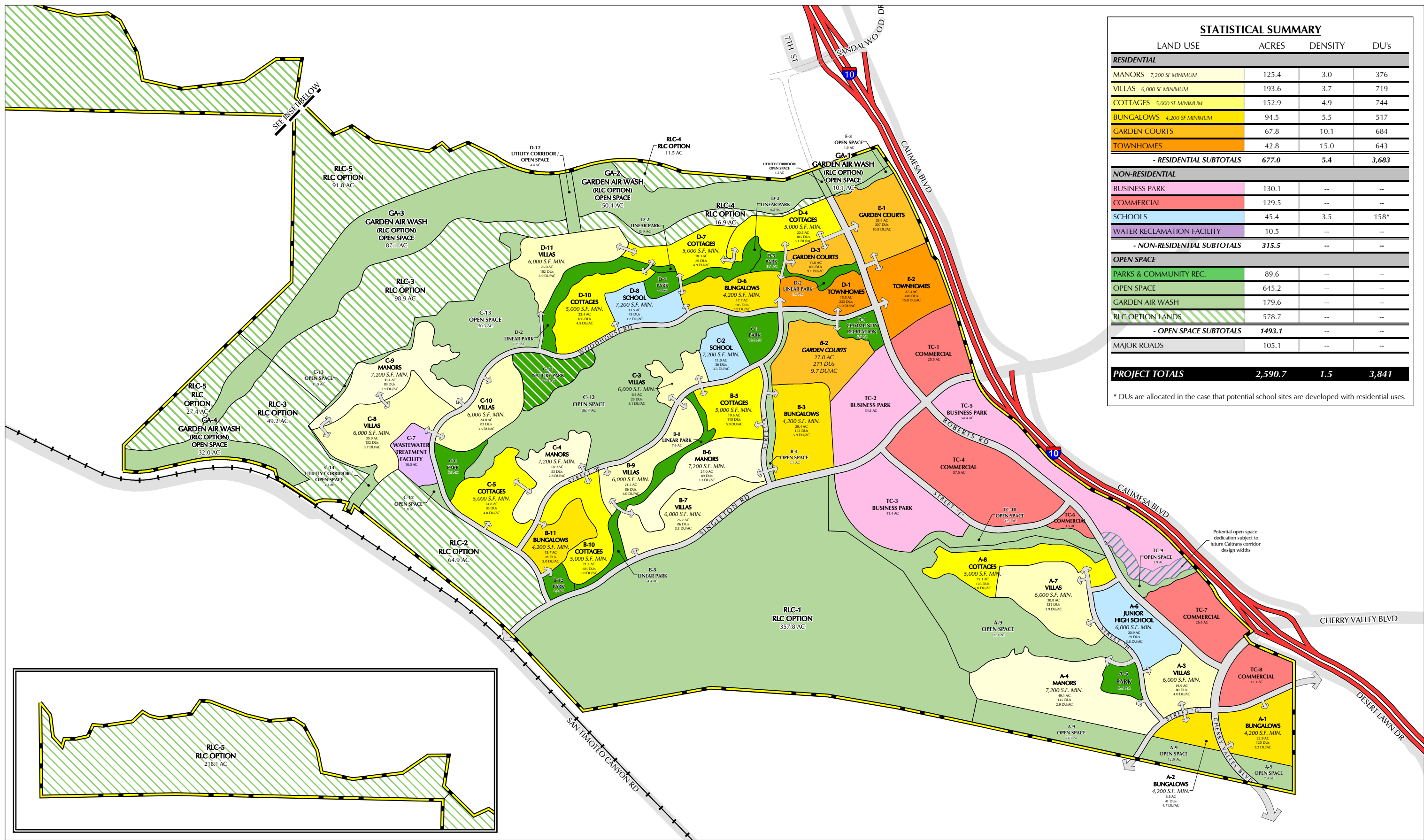

STATISTICAL SUMMARY			
LAND USE	ACRES	DENSITY	DU's
RESIDENTIAL			
MANORS 7,200 SF MINIMUM	125.4	3.0	376
VILLAS 6,000 SF MINIMUM	193.6	3.7	719
COTTAGES 5,000 SF MINIMUM	152.9	4.9	744
BUNGALOWS 4,200 SF MINIMUM	94.5	5.5	517
GARDEN COURTS	67.8	10.1	684
TOWNHOMES	42.8	15.0	643
- RESIDENTIAL SUBTOTALS	677.0	5.4	3,683
NON-RESIDENTIAL			
BUSINESS PARK	130.1	--	--
COMMERCIAL	129.5	--	--
SCHOOLS	45.4	3.5	158*
WATER RECLAMATION FACILITY	10.5	--	--
- NON-RESIDENTIAL SUBTOTALS	315.5	--	--
OPEN SPACE			
PARKS & COMMUNITY REC.	89.6	--	--
OPEN SPACE	645.2	--	--
GARDEN AIR WASH	179.6	--	--
RLC OPTION LANDS	578.7	--	--
- OPEN SPACE SUBTOTALS	1493.1	--	--
MAJOR ROADS	105.1	--	--
PROJECT TOTALS	2,590.7	1.5	3,841

* DU's are allocated in the case that potential school sites are developed with residential uses.

SUMMERWIND RANCH AT OAK VALLEY

Specific Plan Area No. 1,
Amendment No. 1

T&B PLANNING CONSULTANTS
17542 East 17th Street, Suite 100 Tustin, CA 92780
p: 714.505.6360 f: 714.505.6361
www.tbplanning.com



FIGURE I-3

SPECIFIC PLAN LAND USE PLAN

Specific Plan Area No. 1 proposed a 36-hole golf course, and included multiple options for alignments of the certain reaches of the course. One of these options is located on approximately 110 acres within the SUMMERWIND RANCH AT OAK VALLEY Amendment No. 1 area. The golf course alignment option within this SPA has been eliminated, as a result of the final build-out of the 36-hole SCPGA at Oak Valley Golf Club. Subsequently, a majority of the areas set forth as golf course in Specific Plan Area No. 1 have been re-designated as open space in this SPA. Recreation facilities planned in Specific Plan Area No. 1 have been reduced in size and scope in Amendment No. 1 due to a substantial reduction in future community residents, as well as changing market conditions.

In addition, Amendment No. 1 revises the location and acreage of preserved open space by preserving significant environmental resources including: ridgelines, drainages, potential wildlife corridors, and oak trees. More specifically, the distribution of land use set forth within Specific Plan Area No. 1 does not preserve the Garden Air Wash, a significant landform that contributes to drainage and wildlife movement on a local and sub-regional level.

Amendment No. 1 seeks to revise the alignment of the internal roadway network within Specific Plan Area No. 1. Internal roadways were designed in response to the clustering of neighborhoods and the preservation and subsequent sensitivity to environmental areas such as ridgelines, drainages and valleys, oak trees, and wildlife corridors. In this SPA, Singleton Road was re-aligned to serve as a buffer between development and the open space areas provided in the 357.8 acres of open space in RLC-1. Specific Plan Area No. 1 planned for a collector roadway throughout areas in the Garden Air Wash. Amendment No. 1 realigns the collector road away from this sensitive environmental area, allowing the Garden Air Wash to serve as an integral segment of a regional wildlife corridor.

Figure I-4, *Specific Plan Area No. 1 Land Uses vs. Amendment No. 1 Land Uses*, depicts a side-by-side comparison of the land use distributions planned in Amendment No. 1 to those planned in Specific Plan Area No. 1. Figure I-5, *Specific Plan Area No. 1 vs. Amendment No. 1 Overlay Comparison* provides a visual overlay of the planned development envelope within Specific Plan Area No. 1 versus developable areas planned within this SPA.

Chart I-1, *Land Use Acreage Comparison*, and Table I-1, *Specific Plan Area No. 1 vs. Amendment No. 1 Land Use Comparison*, graphically and statistically compare this Specific Plan Amendment with approved Specific Plan Area No 1.

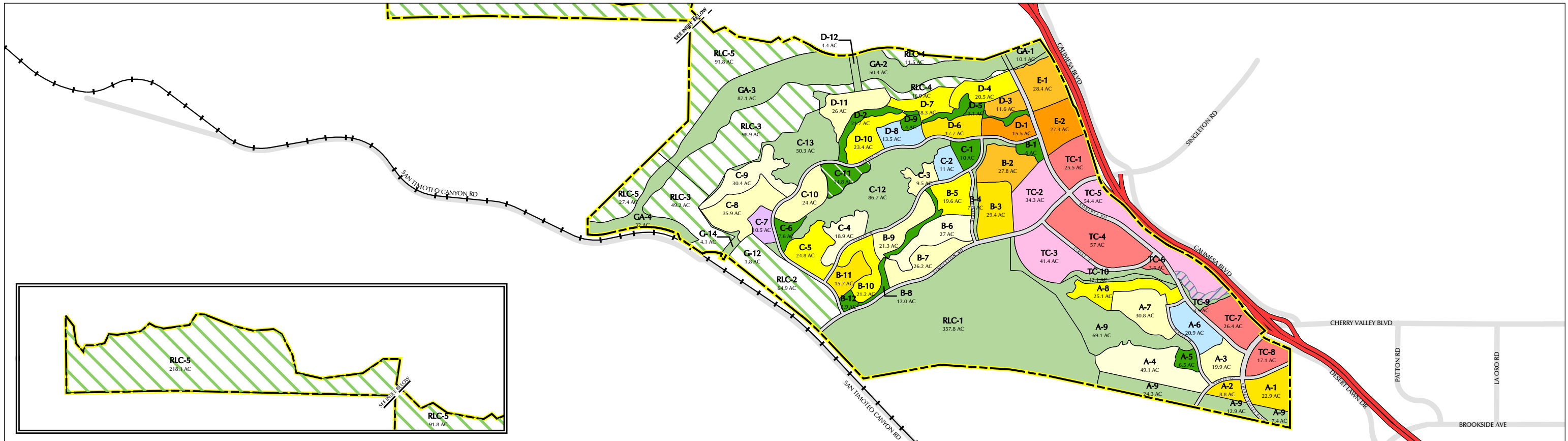

SUMMERWIND RANCH AT OAK VALLEY

Specific Plan Area No. 1,
Amendment No. 1

SPECIFIC PLAN AREA NO. 1 LAND USES VS. AMENDMENT NO.1 LAND USES

FIGURE I-4

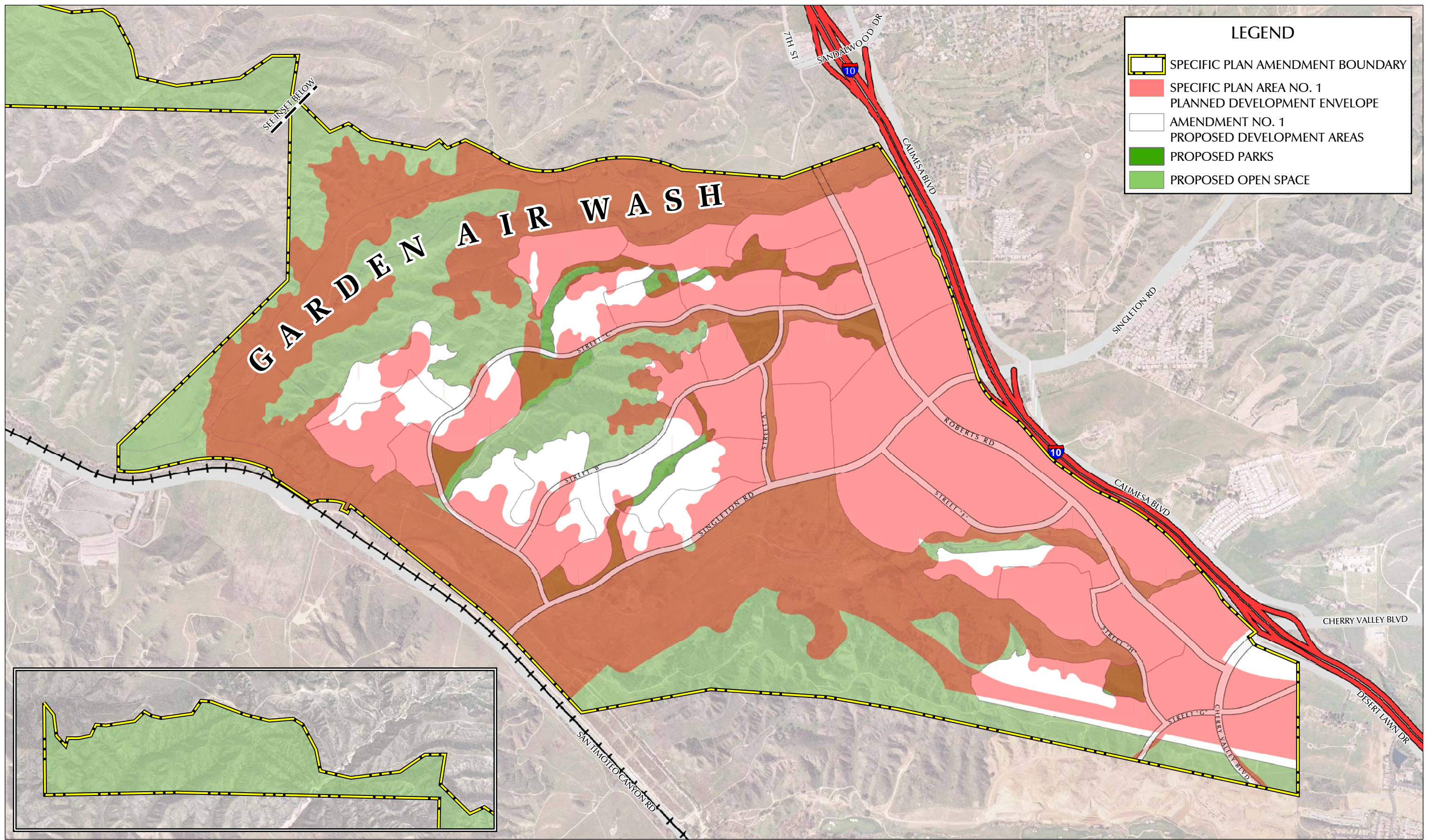

LEGEND

- SPECIFIC PLAN AMENDMENT BOUNDARY
- SPECIFIC PLAN AREA NO. 1
- AMENDMENT NO. 1
- PROPOSED DEVELOPMENT AREAS
- PROPOSED PARKS
- PROPOSED OPEN SPACE

SUMMERWIND RANCH AT OAK VALLEY

Specific Plan Area No. 1,
Amendment No. 1

T&B PLANNING CONSULTANTS
 17542 East 17th Street, Suite 100 | Tustin, CA 92780
 p. 714.305.6360 | f. 714.305.6361
 www.tbplanning.com

SPECIFIC PLAN AREA NO. 1 vs. AMENDMENT NO. 1 OVERLAY COMPARISON

FIGURE 1-5

Chart I-1
Land Use Acreage Comparison

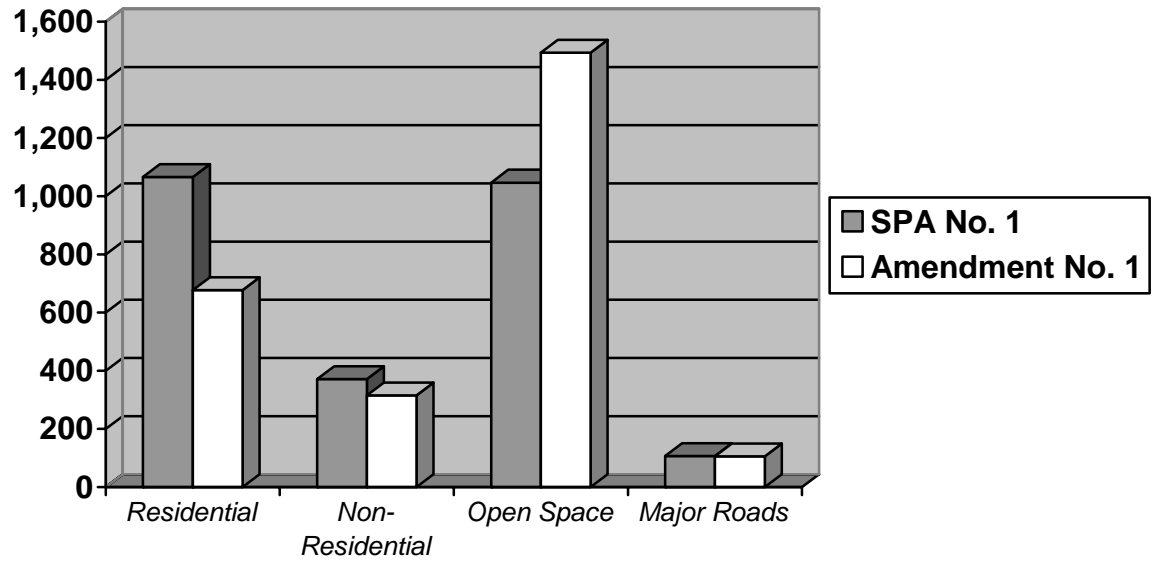

Table I-1: Specific Plan Area No. 1 vs. Amendment No. 1 Land Use Comparison

LAND USE	Specific Plan Area No. 1 Adopted Land Uses			Amendment No. 1 Proposed Land Uses ¹		
	ACRES	DENSITY	DU's	ACRES	DENSITY	DU's
RESIDENTIAL³						
LOW DENSITY .4- 2du/ac	80.2	0.4 - 2.0	123	0.0	0.0	0
MEDIUM DENSITY 2-5 du/ac	541.4	2.0 - 5.0	2,135	471.9	3.0 - 4.9	1,839
MEDIUM HIGH DENSITY 5-8 du/ac	262.9	5.0 - 8.0	1,597	94.5	5.5	517
HIGH DENSITY 8-14 du/ac	181.7	8.0 - 14.0	2,080	67.8	10.1	684
VERY HIGH DENSITY 14-20 du/ac	0.0	14.0 - 20.0	0	42.8	15.0	643
RESIDENTIAL SUBTOTALS	1,066.2	5.6	5,935	677.0	5.4	3,683
NON-RESIDENTIAL						
BUSINESS PARK	0.0	--	--	130.1	--	--
COMMERCIAL	314.4	--	--	129.5	--	--
FIRE STATION	3.4	--	--	0.0	--	--
SCHOOLS	39.2	--	57 ²	46.2	3.4	158 ²
WORSHIP CENTER	14.2	--	--	0.0	--	--
WATER RECLAMATION FACILITY	0.0	--	--	10.5	--	--
NON-RESIDENTIAL SUBTOTALS	371.2	--	57	315.5	--	158²
OPEN SPACE						
PARKS & RECREATION	86.4	--	--	89.6	--	--
GOLF COURSE	110.9	--	--	0.0	--	--
OPEN SPACE	849.5	--	--	645.2	--	--
GARDEN AIR WASH	0.0	--	--	179.6	--	--
RLC OPTION LANDS	0.0	--	--	578.7	--	--
OPEN SPACE SUBTOTALS	1,046.8	--	--	1493.1	--	--
MAJOR ROADS	106.5	--	--	105.1	--	--
PROJECT TOTALS	2,590.7	2.3	5,992	2,590.7	1.5	3,841

1. For comparison purposes, proposed residential land uses are converted to the equivalent of adopted land uses in Specific Plan Area No. 1.
2. Maximum number of dwelling units that can be developed on school sites.
3. Land use density definitions used in Specific Plan Area No. 1.

II. PROJECT SUMMARY

A. Project Description

1. Regional and Local Setting

As depicted in Figure II-1, *Regional Map*, SUMMERWIND RANCH AT OAK VALLEY is located in the City of Calimesa, which is located in northwestern Riverside County, California. More specifically it is located approximately five miles northwest of the junction of Interstate 10 (I-10) and Highway 60, and approximately seven miles south of the foothills of the San Bernardino National Forest. Located south and east of the Specific Plan Amendment (SPA) area are the cities of Beaumont and Banning. The cities of Redlands and Yucaipa are located to the north of the Specific Plan Amendment Area.

Figure II-2, *Vicinity Map*, depicts the Specific Plan Amendment No. 1 Area and its surrounding jurisdictions, as well as two significant open space areas, Norton Younglove Preserve and San Timoteo Canyon State Park. The easterly portion of the Amendment No. 1 boundary runs parallel and adjacent to the rights-of-way for the I-10 Freeway. Two interchanges, I-10/Cherry Valley Boulevard and I-10/Singleton Road, are located along this shared boundary. The southwesterly portion of the Amendment No. 1 boundary is defined by the alignment of San Timoteo Canyon Road.

As shown in Figure II-3, *Aerial Photograph*, the SUMMERWIND RANCH AT OAK VALLEY Amendment No. 1 area is surrounded by rolling terrain, as well as developed and undeveloped areas within the City of Calimesa.

B. Existing Site Characteristics

1. Topography

The topography of the site consists of gently to moderately rolling hills and ridgelines, separated by broad valleys and narrow ravines, all scattered with oak trees and scrub vegetation. These valleys and ravines act as natural drainage courses and contain several streambeds. As shown in Figure II-4, *Topographic map*, elevations throughout the site range from valley lows of approximately 1,950 feet to ridgelines of approximately 2,425 feet.

Located within the Beaumont Plains, the property generally slopes gently to the southwest toward San Timoteo Creek. Erosion of the relatively flat lying bedrock unit in this semi-arid environment has resulted in a dendrite drainage pattern characterized by a series of major southwest drainages with numerous related re-entrant drainages.

The majority of the resulting slopes vary from flat to gently sloping in the canyon bottoms, and from 3:1 to 2:1 slope ratios along the ascending natural slopes. Localized areas of recent erosion have produced near-vertical slope faces within some alluvial canyons. Near-vertical slopes of up to twenty

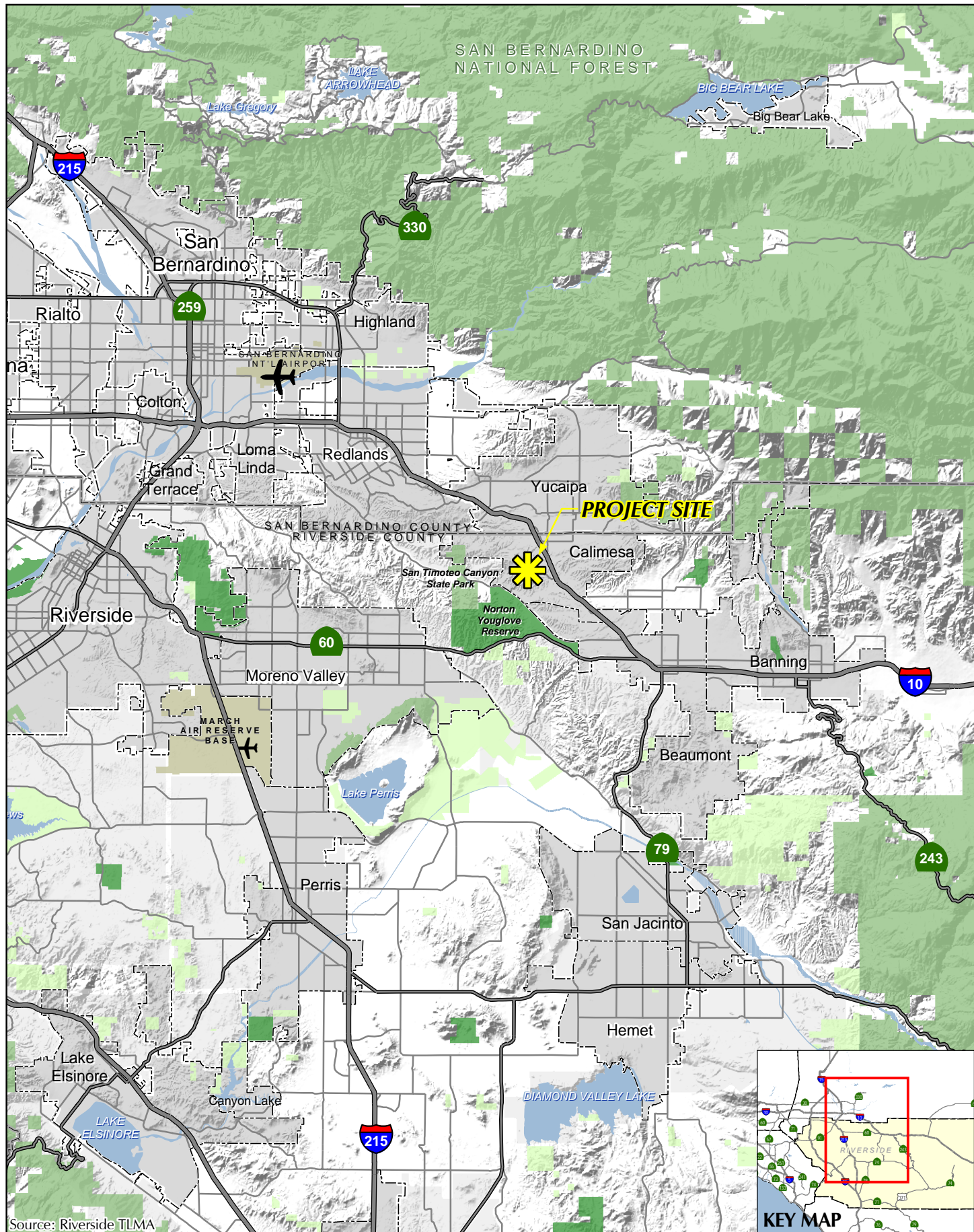

Source: Riverside TLMA

SUMMERWIND RANCH AT OAK VALLEY

Specific Plan Area No. 1,
Amendment No. 1

T&B PLANNING CONSULTANTS
1742 East 17th Street, Suite 100 Tustin, CA 92780
p. 714.505.6360 f. 714.505.6361
www.tbplanning.com



FIGURE II-1
REGIONAL MAP

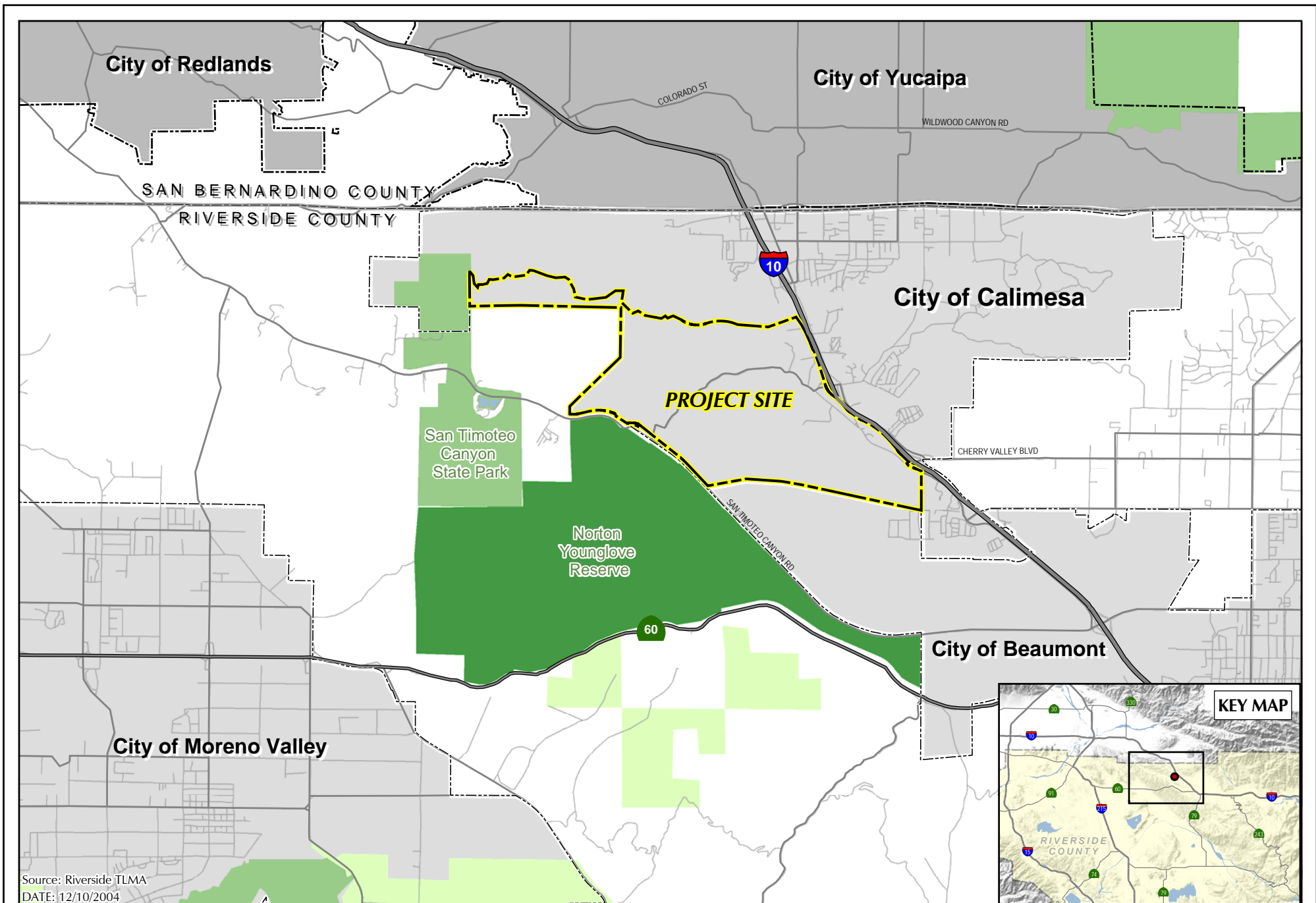

SUMMERWIND RANCH AT OAK VALLEY

Specific Plan Area No. 1,
Amendment No. 1

T&B PLANNING CONSULTANTS
17542 East 17th Street, Suite 100 Tustin, CA 92780
p: 714.505.6369 f: 714.505.6361
www.tbplanning.com



FIGURE II-2
VICINITY MAP



Source: Eagle Aerial (flown 2004)

SUMMERWIND RANCH AT OAK VALLEY

Specific Plan Area No. 1,
Amendment No. 1



FIGURE II-3

AERIAL PHOTOGRAPH

PAGE II-4

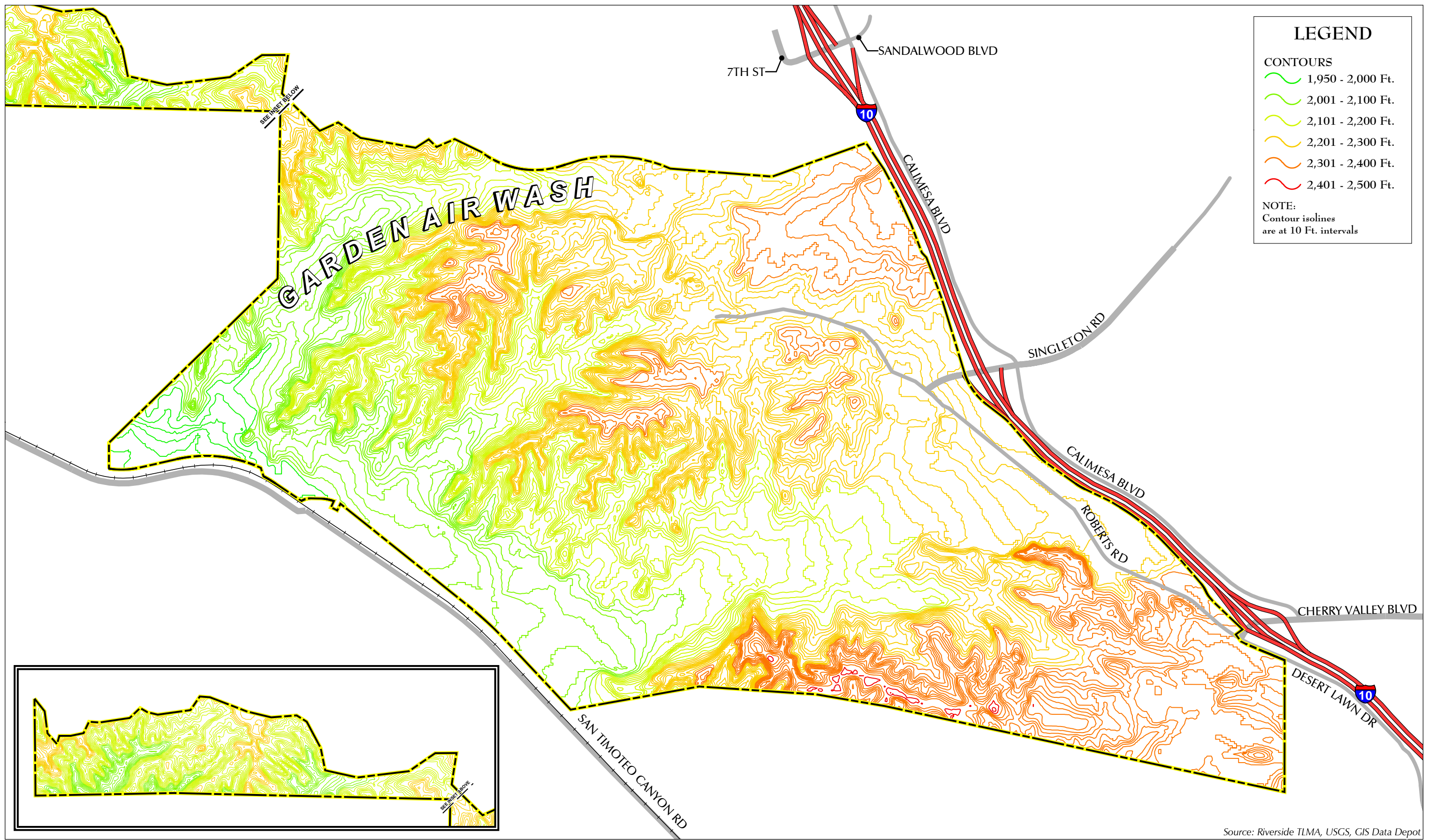

LEGEND

CONTOURS

- 1,950 - 2,000 Ft.
- 2,001 - 2,100 Ft.
- 2,101 - 2,200 Ft.
- 2,201 - 2,300 Ft.
- 2,301 - 2,400 Ft.
- 2,401 - 2,500 Ft.

NOTE:
Contour isolines are at 10 Ft. intervals

Source: Riverside TLMA, USGS, GIS Data Depot

SUMMERWIND RANCH AT OAK VALLEY

FIGURE II-4

TOPOGRAPHIC MAP

Specific Plan Area No. 1,
Amendment No. 1



feet high exist in a portion of a canyon located within the northern portion of SUMMERWIND RANCH AT OAK VALLEY. In addition, headward erosion of the major re-entrant drainages has produced some slope areas steepened to ratios of approximately 1:1.

2. Drainage

The Amendment No. 1 area lies within the watershed of the Santa Ana River and its tributaries, defined as the Santa Ana Region. The Santa Ana River and its tributaries drain the southern portions of the eastern San Gabriel Mountains and the southern parts of the San Bernardino Mountains over an area of approximately 2,700 square miles. The site is situated within the largest underground water basin in the region, the Upper Santa Ana River Basin. Surface and groundwaters in the upper basin eventually flow through Prado Dam, at the head of the Santa Ana River Canyon, and down into the Orange County Coastal Basin, or lower basin.

The Amendment No. 1 project site is within the San Timoteo Sub-basin of the Upper Santa Ana Region. The San Timoteo Sub-basin underlies Cherry Valley and the City of Beaumont and covers an area of 73,100 acres. The San Timoteo Sub-basin is drained by Little San Geronimo Creek and San Timoteo Canyon to the Santa Ana River.

Several natural streambeds are located throughout the Amendment No. 1 project site. The broad flat alluvial plateaus are divided by steep sides and wide bottom ravines that serve as regional and sub-regional drainage courses.

The Garden Air Wash, an intermittent wetland, is the most prominent surface drainage feature in the northern portion of the project site and ranges from 20 to 40 feet wide. The wash flows into the southwestern reaches of the site into areas of riparian woodland.

The northwesterly portion of the project site contains two small ephemeral non-wetlands of between 1 to 2 feet wide. Two non-wetlands waters originate near the eastern boundary of the site and include intermittent non-wetlands and ephemeral non-wetlands. These non-wetlands range from 2 to 20-feet wide and flow west towards a wet meadow located along the southwestern boundary of the project site. An additional non-ephemeral wetland originates near the center of the project site and flows south towards a riparian woodland.

3. Biological Resources

Eight vegetation communities and cover types have been identified within the Amendment No. 1 project site. Native vegetation consists of chaparral, coastal sage scrub, meadow, oak woodland, and riparian woodland. Disturbed, non-native cover types such as agricultural land, ornamental trees, and non-native grasses also occur within the project site due to extensive agricultural and grazing practices over the past century.

4. Soils & Geology

Topsoil

Topsoil is present throughout the majority of the site. It typically forms a mantle of one to two feet on the underlying parent unit and predominantly consists of dark brown silty sand that is generally loose, highly compressible, and varies from dry to wet, depending upon climatic and anthropic conditions. This material has been disturbed by previous agricultural activities. In areas where undisturbed soil development has developed on top of the San Timoteo Formation, it is composed of clayey sand with some gravel that is red-brown, slightly moist, and moderately dense with visible porosity, with abundant secondary clay development. This material has been mapped as a separate geologic unit (relic paleosols) by previous investigators.

Artificial Fill (afu)

Existing artificial fill associated with small earthen dams is located on many areas of the site. This material was probably derived from the onsite soils and reflects similar characteristics.

Alluvium and Colluvium (Qal)

Recent (Holocene-age) alluvium and colluvium exists within the streambeds and tributary drainages of the subject site. These sediments originated from the surrounding soil and bedrock units and have been transported by water (alluvium) and/or gravity (colluvium). The alluvium is consistently comprised of silty sands with some gravel and occasional cobbles. It is loose to medium dense, porous, and slightly moist to wet. Alluvial deposits within the subject site were observed to extend to depths exceeding 48 feet. Colluvium at the site is generally silty sand and gravelly sand with some clay and cobbles. This material has been observed to be red brown to brown, highly porous and dry to slightly moist.

Older Alluvium (Qoa)

Older alluvium at the site represents the dissected remnants of the former floodplain/streambed that was produced during the latest Pleistocene time. The older alluvium deposits are typically reddish brown, silty to clayey sands, with some sand lenses. This material ranges from moderately dense to very dense, and is generally moist. This unit was observed to be up to 30 feet thick in boring B-30. The base of this unit was marked in some areas by a coarsening of clast size, representing a lag deposit above an erosional discontinuity with the underlying San Timoteo Formation.

San Timoteo Formation (QTst)

The San Timoteo Formation encountered at the site appears to be predominantly a thickly interbedded to interlensed light yellow-brown to light gray, and light red brown conglomerate, and fine to medium grained clayey sandstone. In addition, some light yellow brown to red brown sandy siltstone beds, up to eight feet thick, are present. This unit is moderately hard and slightly cemented in some areas. Some of the gravelly sandstone lenses are friable, and exhibit low cohesion.

5. Historic and Cultural Land Use

The earliest direct evidence of prehistoric occupation of the project vicinity dates to approximately 5000 to 400 BC, a period characterized in the west by materials of the Encinitas tradition such as milling stones, cogged and discordal stones, and a flaked stone industry of chopping, scraping and cutting tools. During the Mexican period, major land grants encompassing the project area included the San Timoteo Rancho and the tract between San Jacinto and San Gorgonio. The project site comprises the northern one-third of Rancho San Timoteo.

San Timoteo Canyon emerged as a significant travel corridor during the American period. Butterfield Overland mail operations crossed the study area and the discovery of gold in Arizona led to the establishment of the Bradshaw Road through areas in San Timoteo Canyon. The Southern Pacific Railroad completed its line from Los Angeles through San Gorgonio Pass in 1876 which spawned agricultural and land development opportunities in the project vicinity.

C. Sensitive Environmental Resources

Detailed analysis of the existing site characteristics highlighted key environmental resources that were deemed sensitive and necessary for preservation. The identified sensitive environmental resources include numerous ridgelines, important drainages (as well as their contiguous valleys and ravines), and potential wildlife corridors. Figure II-5, *Sensitive Environmental Areas Map*, illustrates the sensitive environmental areas located within SUMMERWIND RANCH AT OAK VALLEY.



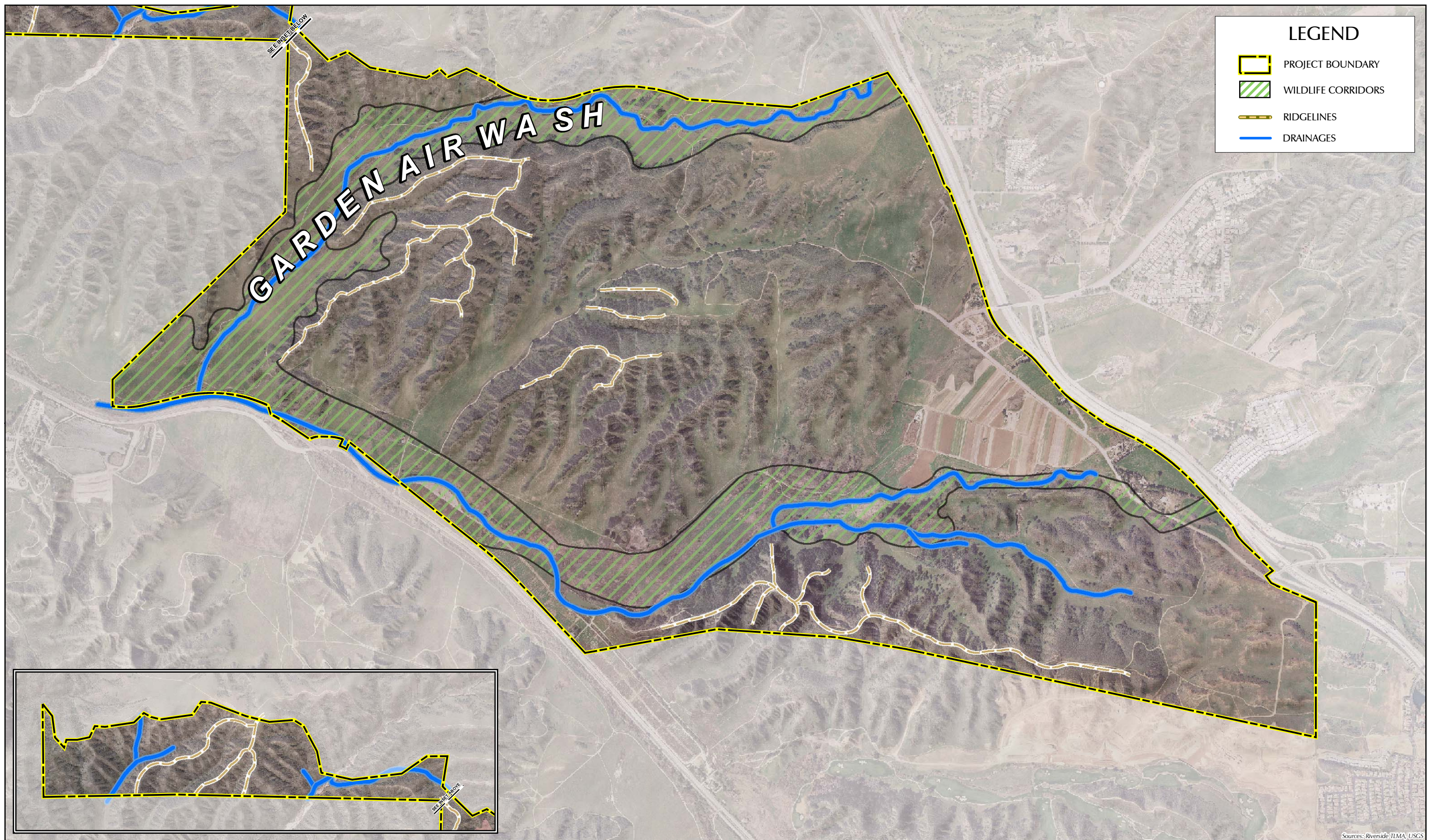

Sensitive ridgelines are generally identified in the City of Calimesa General Plan as a part of the Resource Management Plan. During the pre-design analysis of the SPA area, the project team conducted focused studies of these areas and identified more ridgelines that were considered highly sensitive. Sensitive ridgelines are dispersed throughout the SPA site, as indicated on Figure II-5.

The City of Calimesa's General Plan also generally identifies major drainage courses, of which the only one that falls within the Amendment No. 1 area is Garden Air Wash. Utilizing a detailed jurisdictional delineation map, the project biologist expanded upon the City's definition and identified other sensitive drainage course that contain a series of intermittent wetlands, wet meadows, riparian woodlands, and ephemeral wetlands. These drainages are located throughout the Amendment No. 1 area, as illustrated on Figure II-5.

While the currently approved land use plan does not allow for wildlife corridors, the project team identified potential wildlife corridors that could contribute to both local and regional ecological systems. Garden Air Wash is the most significant as it has been identified by the City and County as a potential wildlife corridor of regional significance. Garden Air Wash is the southerly segment of Constrained Linkage 23 in Riverside County's MSHCP. A Constrained Linkage is a constricted connection expected to provide for movement of identified Planning Species between Core Areas, where options for assembly of the connection are limited due to existing patterns of use.



LEGEND

-  PROJECT BOUNDARY
-  WILDLIFE CORRIDORS
-  RIDGELINES
-  DRAINAGES

SUMMERWIND RANCH AT OAK VALLEY

FIGURE II-5

SENSITIVE ENVIRONMENTAL AREAS MAP

According to the County's MSHCP, proposed Constrained Linkage 23 is an upland Linkage located in the vicinity of Cherry Valley, which provides a connection to Bogart County Park and San Timoteo Creek for certain species. This Linkage is constrained by surrounding existing urban and rural residential Development in the City of Calimesa. Planning Species for which habitat is provided within this Linkage include Bell's sage sparrow, Los Angeles pocket mouse, and San Bernardino mountain kingsnake. Maintenance of a contiguous connection is important for these species. This Linkage likely provides for movement of common mammals such as bobcat.

The second potential wildlife corridor is contiguous with the sensitive drainages that run through the south central portions of the site. This corridor has been identified by the City as the Cherry Valley Corridor. The potential corridor is constrained by the I-10 Freeway at its easterly terminus and connects to the potential Garden Air Wash corridor to the north. Should a connection be established above the I-10 Freeway, the corridor would continue north and terminate in the foothills of the San Bernardino National Forest.

As shown in Figure II-6, *Approved Plan with Sensitive Environmental Areas Overlay*, the development envelope in Specific Plan Area No. 1 significantly impacted sensitive environmental areas. Specific Plan Area No. 1 impacted sensitive ridgelines, drainages, and eliminate the viability any wildlife corridors.

In contrast, the proposed development, Amendment No. 1 development envelope associated with SUMMERWIND RANCH AT OAK VALLEY avoids sensitive environmental areas, identified in II-7, *Proposed Plan with Sensitive Environmental Areas Overlay*.

SUMMERWIND RANCH AT OAK VALLEY is designed to protect sensitive environmental areas. Amendment No. 1 protects additional sensitive environmental areas beyond the General Plan vision. As depicted in Figure II-7, significant ridgelines, drainages, valleys and ravines, and wildlife corridors are retained in their natural condition as much as feasible.

SUMMERWIND RANCH AT OAK VALLEY provides 1,493.1 acres of open space. Due to the sensitive biological resources contained in the open space areas, access to these areas will be restricted to well-marked trail systems. In many areas of SUMMERWIND RANCH AT OAK VALLEY, natural open space and ridgelines will act as a buffer between the proposed land uses and the more sensitive biological resources contained in the RLC Lands. Amendment No. 1 seeks to conserve and protect important plant communities and wildlife habitats, such as riparian areas, wetlands, and oak woodlands by using buffers, creative site planning, re-vegetation, and open space dedications.

Where manufactured slopes are planned adjacent to or within natural open space areas, the slopes will be planted with native vegetation, consistent with the hillside development provisions of the Specific Plan Amendment. Hillside development regulations which provide sensitivity to the natural topography of the development site will be implemented under Amendment No. 1. Hillside Development Regulations are contained in *Section VI* of this Specific Plan Amendment.

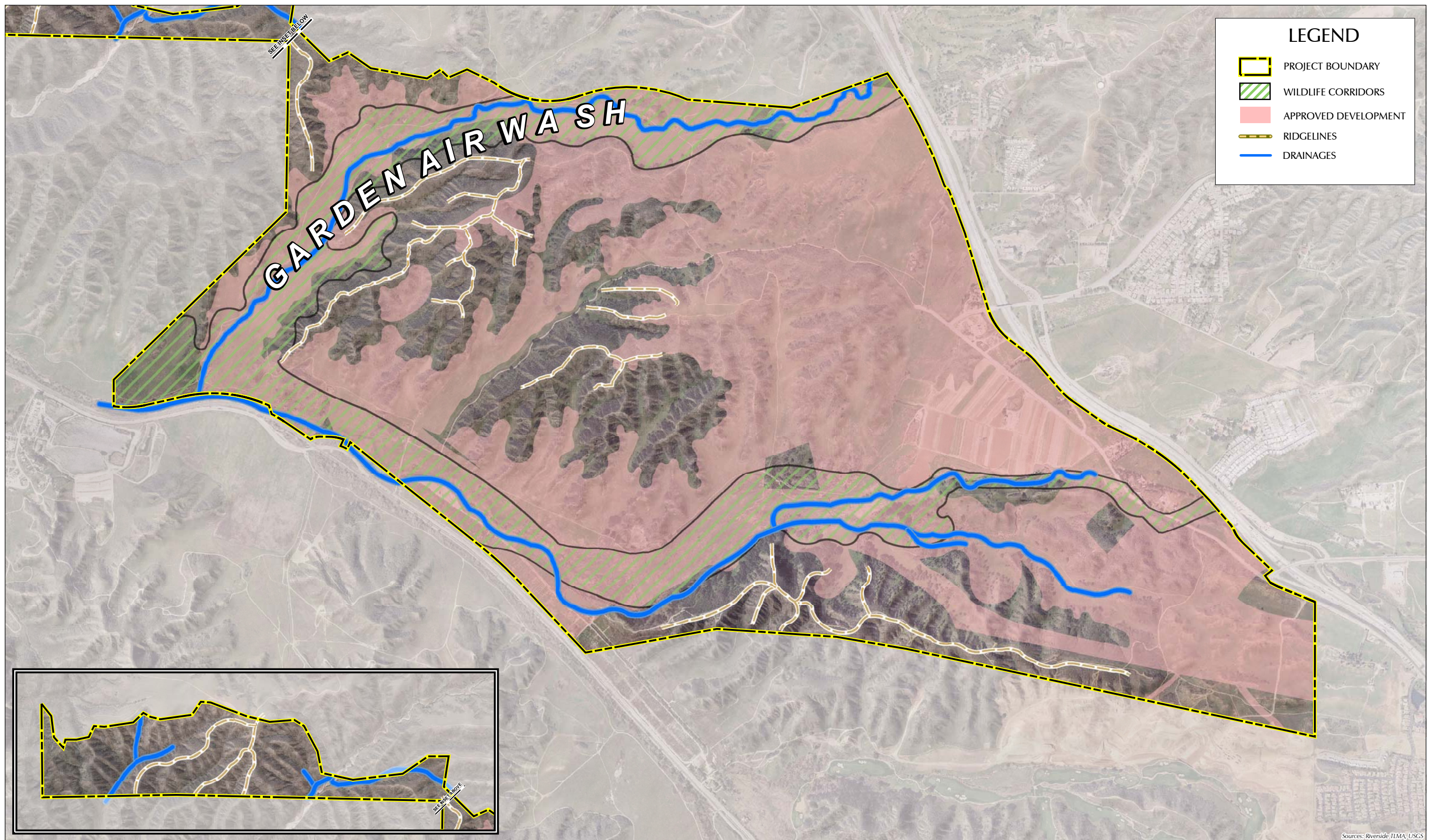

LEGEND

- PROJECT BOUNDARY
- WILDLIFE CORRIDORS
- APPROVED DEVELOPMENT
- RIDGELINES
- DRAINAGES

SUMMERWIND RANCH AT OAK VALLEY

Specific Plan Area No. 1,
Amendment No. 1



APPROVED PLAN WITH SENSITIVE ENVIRONMENTAL AREAS OVERLAY

FIGURE II-6

Sources: Riverside TLMA, USGS

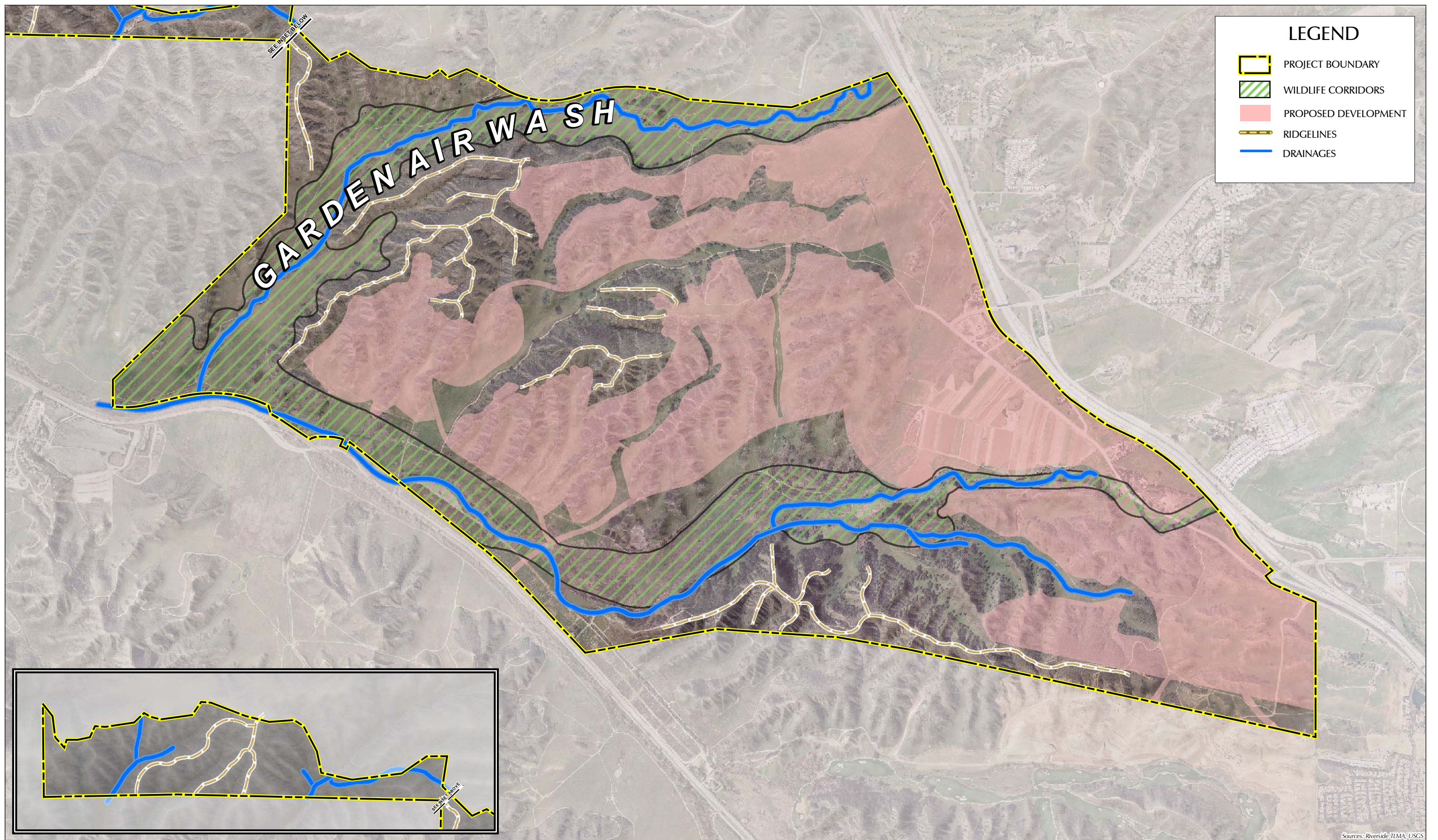

Sources: Riverside TLMA, USGS

SUMMERWIND RANCH AT OAK VALLEY

Specific Plan Area No. 1,
Amendment No. 1



PROPOSED PLAN WITH SENSITIVE ENVIRONMENTAL AREAS OVERLAY

FIGURE II-7

Where wildlife corridors encompass manufactured slopes or where such slopes adjoin wildlife corridors, the slopes will be planted with native vegetation to create conditions replicating natural habitat conditions. Local wildlife movement will also be accommodated via the interconnection of preserved habitat blocks and by preservation of a minimum 50-foot wide riparian corridor along an existing drainage course located north of the Cherry Valley Boulevard Interchange. If wildlife movement is further facilitated by off-site improvements (i.e. modifications to the existing culverts beneath I-10 and preservation of a connecting corridor east of I-10), then the preserved corridor would be widened to 300 feet in width. Accordingly, the Specific Plan Amendment will reserve land within designated open space areas for the broadened 300 foot corridor. This reservation will be maintained for a period of three years following adoption of this Specific Plan Amendment. If during this time, financing for improvements to the culvert is secured and a program to preserve a functional corridor east of I-10 is adopted, the corridor within SUMMERWIND RANCH AT OAK VALLEY will be improved at a width of 300 feet.

D. Existing and Surrounding Land Use

As depicted in Figure II-8, *Existing and Surrounding Land Uses*, the Specific Plan Amendment area is currently undeveloped, with a small portion of land used for farming, agricultural, and rural residential land uses. Currently, the site is surrounded to the north, west, and southwest by undeveloped natural open space areas. The Norton Younglove Preserve and San Timoteo Canyon State Park are located to the southwest and west of the project site, respectively. Future development is planned within the City of Calimesa adjacent to the northerly boundary of the Specific Plan Amendment area. To the south and southeast of the project site lies the Oak Valley Champions project in the City of Beaumont. Oak Valley Champions is a master planned golf-course community that will ultimately consist of a mix of open space, residential, golf course, and commercial uses. Varying densities of mobile homes and single-family residences are located adjacent to the eastern edge of SUMMERWIND RANCH AT OAK VALLEY and east of I-10.

E. Project Summary

SUMMERWIND RANCH AT OAK VALLEY is a master planned community expressing sensitivity to the natural environment while providing for a variety of integrated land uses. This Specific Plan Amendment will include a mix of residential, commercial, and business park uses, as well as schools, parks and recreation, and natural open space. More detailed information on the proposed land uses and their location is provided in Section III, *Specific Plan*, of this document.

Primary development objectives include implementation of a land use plan which features the environmental and aesthetic assets of the site while providing the community of SUMMERWIND RANCH AT OAK VALLEY with a range of public and private recreational, residential, commercial, and

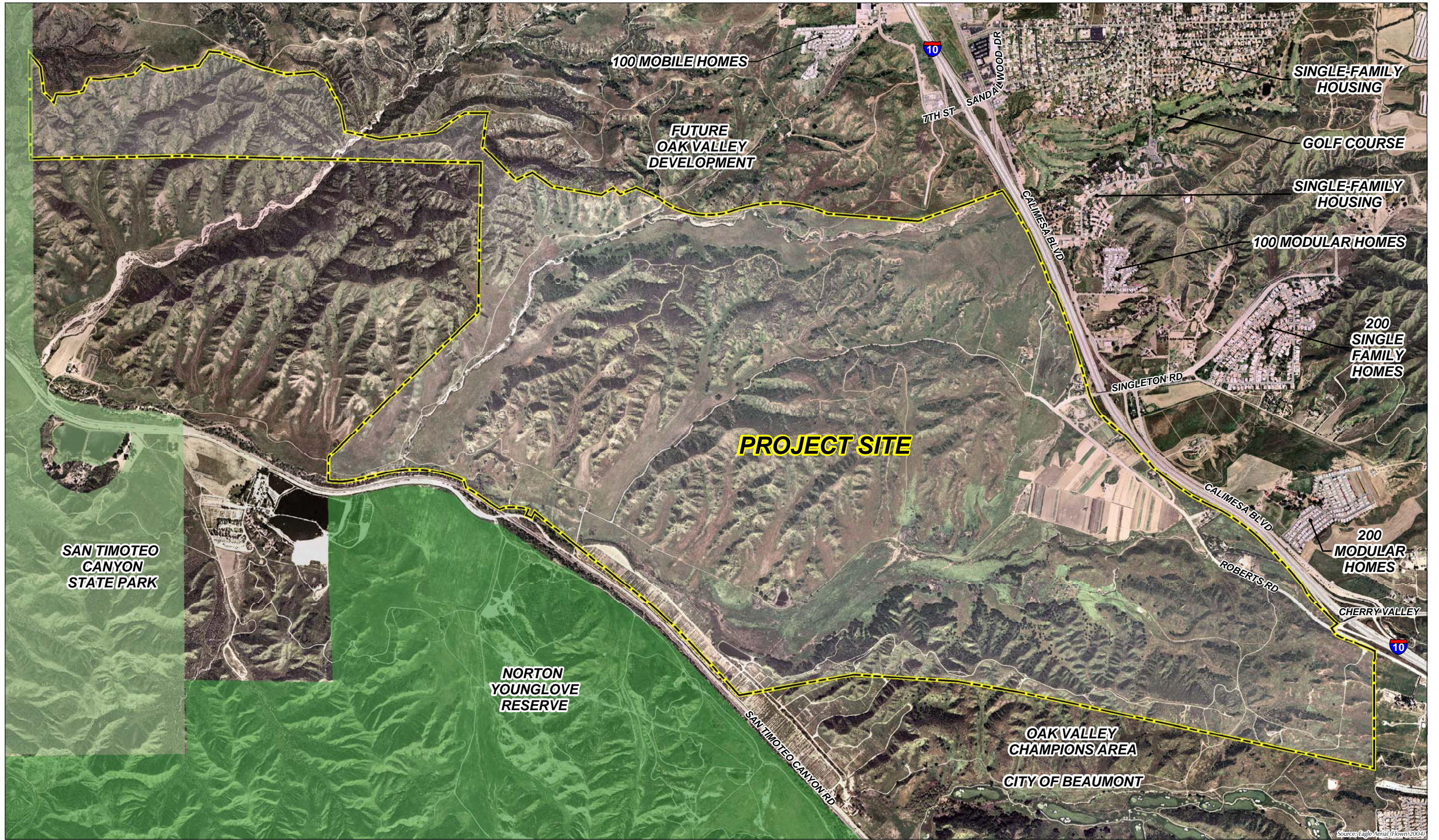

SUMMERWIND RANCH AT OAK VALLEY

Specific Plan Area No. 1,
Amendment No. 1



FIGURE II-8

EXISTING AND SURROUNDING LAND USES

ancillary uses. It is anticipated that the population generated by the eventual buildout of SUMMERWIND RANCH AT OAK VALLEY will be served by several commercial centers and business parks to be conveniently located at circulation nodes adjacent to Interstate 10 (I-10) and throughout the proposed Town Center. The Town Center will be comprised of 129.5 acres of commercial uses and 130.1 acres of business park uses. The Town Center may also consist of a variety of public and semi-public uses set in an urban core which will provide a range of services to the residents of the community.

SUMMERWIND RANCH AT OAK VALLEY will contain five distinct residential villages (Villages A through E). A total of 3,683 dwelling units on approximately 677.0 acres are planned to provide housing at buildout. In the event that the School District does not exercise its option to locate schools within the SUMMERWIND RANCH AT OAK VALLEY community, an additional 158 dwelling units may be located on the 45.4 acres not used by the School District. The residential development will consist of low, low medium, medium and high density residential land uses.

The recreation and open space areas are designed to offer a mix of active and passive uses ranging from such amenities as picnic areas, tot lots, athletic fields, basketball and tennis courts, and trails. Hiking and equestrian trails will provide additional recreational opportunities in conjunction with strategically located parks to serve surrounding neighborhoods. A community recreation center is also planned on 6.0 acres and will consist of possible recreational uses such as an aquatic center, gym, tot lot, and sport courts.

The master circulation plan for SUMMERWIND RANCH AT OAK VALLEY will be designed in accordance with the roadway standards stipulated in the City of Calimesa General Plan Circulation Element and will adequately service future traffic volumes. The plan proposes the construction of two urban arterials (134' ROW) at project entrances from I-10, two arterials (110' ROW), two majors (100' ROW), two secondaries (88' ROW), one secondary frontage (76' ROW), and five divided collector (78' ROW) roadways.

To service the residential areas of SUMMERWIND RANCH AT OAK VALLEY, as well as persons employed in the project vicinity, various public and semi-public facilities are proposed. These proposed facilities include three school sites and a water reclamation facility. The public utilities and infrastructure necessary to serve the proposed community will be phased in conjunction with development of the property. Yucaipa Valley Water District (YVWD) and Beaumont-Cherry Valley Water District (BCVWD) will provide potable water service to the Specific Plan Amendment area and the Wacholz Treatment Facility will provide sewage treatment. In addition, a water reclamation facility will be located in Village C. Discharge from this plant will connect into a proposed reclaimed water line to be built by Eastern Municipal Water District (EMWD).

SUMMERWIND RANCH AT OAK VALLEY will be phased in a logical sequence and in response to market demands. A total of five (5) development phases are planned. Public facilities, including parks and trails construction, will occur concurrently with residential development according to the Phasing Plan section of this document. Land use statistics are presented in Table II-1, *General Land Use Statistical Summary*.

TABLE II-1
GENERAL LAND USE STATISTICAL SUMMARY

LAND USE	ACRES	DENSITY	DU's
RESIDENTIAL			
MANORS 7,200 SF MINIMUM	125.4	3.0	376
VILLAS 6,000 SF MINIMUM	193.6	3.7	719
COTTAGES 5,000 SF MINIMUM	152.9	4.9	744
BUNGALOWS 4,200 SF MINIMUM	94.5	5.5	517
GARDEN COURTS	67.8	10.1	684
TOWNHOMES	42.8	15.0	643
RESIDENTIAL SUBTOTALS	677.0	5.4	3,683
NON-RESIDENTIAL			
BUSINESS PARK	130.1	--	--
COMMERCIAL	129.5	--	--
SCHOOLS	45.4	3.4	158*
WATER RECLAMATION FACILITY	10.5	--	--
NON-RESIDENTIAL SUBTOTALS	315.5	--	--
OPEN SPACE			
PARKS & COMMUNITY RECREATION	89.6	--	--
OPEN SPACE	645.2	--	--
GARDEN AIR WASH	179.6	--	--
RLC OPTION LANDS	578.7	--	--
OPEN SPACE SUBTOTALS	1493.1	--	--
MAJOR ROADS	105.1	--	--
PROJECT TOTALS	2,590.7	1.5	3,841

*DUs are allocated in the case that potential school sites are developed with residential uses.

III. SPECIFIC PLAN

A. Development Plans and Standards

1. Specific Plan Land Use Plan

a. Project Description

Upon completion, SUMMERWIND RANCH AT OAK VALLEY will provide for a full range and diversity of land uses, including residential, commercial, business park, public use, and open space and recreation on 2,590.7 acres. Each of these land uses has been carefully selected and located on the Specific Land Use Plan to accommodate a variety of needs that a project with the scope and diversity of SUMMERWIND RANCH AT OAK VALLEY will require. The location of the various land uses depicted in Figure III-1, *Specific Plan Land Use Plan*, also takes into consideration existing development, environmental conditions, services, and transportation needs within the vicinity of the site. SUMMERWIND RANCH AT OAK VALLEY will promote development of a well balanced community by incorporating residential land use, a town center, recreation center, schools, parks, and open space into a master-planned development.

This Specific Land Use Plan provides for five basic uses: residential, business park, commercial, public facilities, and open space and recreation. Each of these basic land uses are further divided to accommodate the variety of needs that a project with the scope and diversity SUMMERWIND RANCH AT OAK VALLEY will require. As summarized in Table III-1, *Detailed Land Use Summary*, residential, public facilities, and open space and recreation land uses are primarily located within Villages A through E. Business park and commercial land uses are concentrated in the Town Center Planning Area. Specific information on each individual planning area within the Villages and Town Center which comprise SUMMERWIND RANCH AT OAK VALLEY is provided in Tables III-3 through III-8, and in Figures III-16 through III-21.

The Specific Plan Amendment's overall residential component averages 5.4 dwelling units per acre on 677.0 acres of the 2,590.7 acres, and supports a maximum of 3,683 dwelling units. An additional 158 dwelling units may be developed if one or more of the three proposed school sites are not acquired by the school district. Therefore, the Specific Plan Amendment can support a maximum of 3,841 dwelling units in five development phases. Residential development will be provided at a variety of densities sensitively placed adjacent to large expanses of open space. Accordingly, the homes in SUMMERWIND RANCH AT OAK VALLEY will contribute to meeting the demand for housing in Western Riverside County, while maintaining an environmentally sensitive approach to design, relative to the property's biological and topographical resources. These residences will be distributed among various planning areas as depicted in Figure III-1, most of which are located in the central portions of the Specific Plan Amendment area, and away from Interstate 10 (I-10).

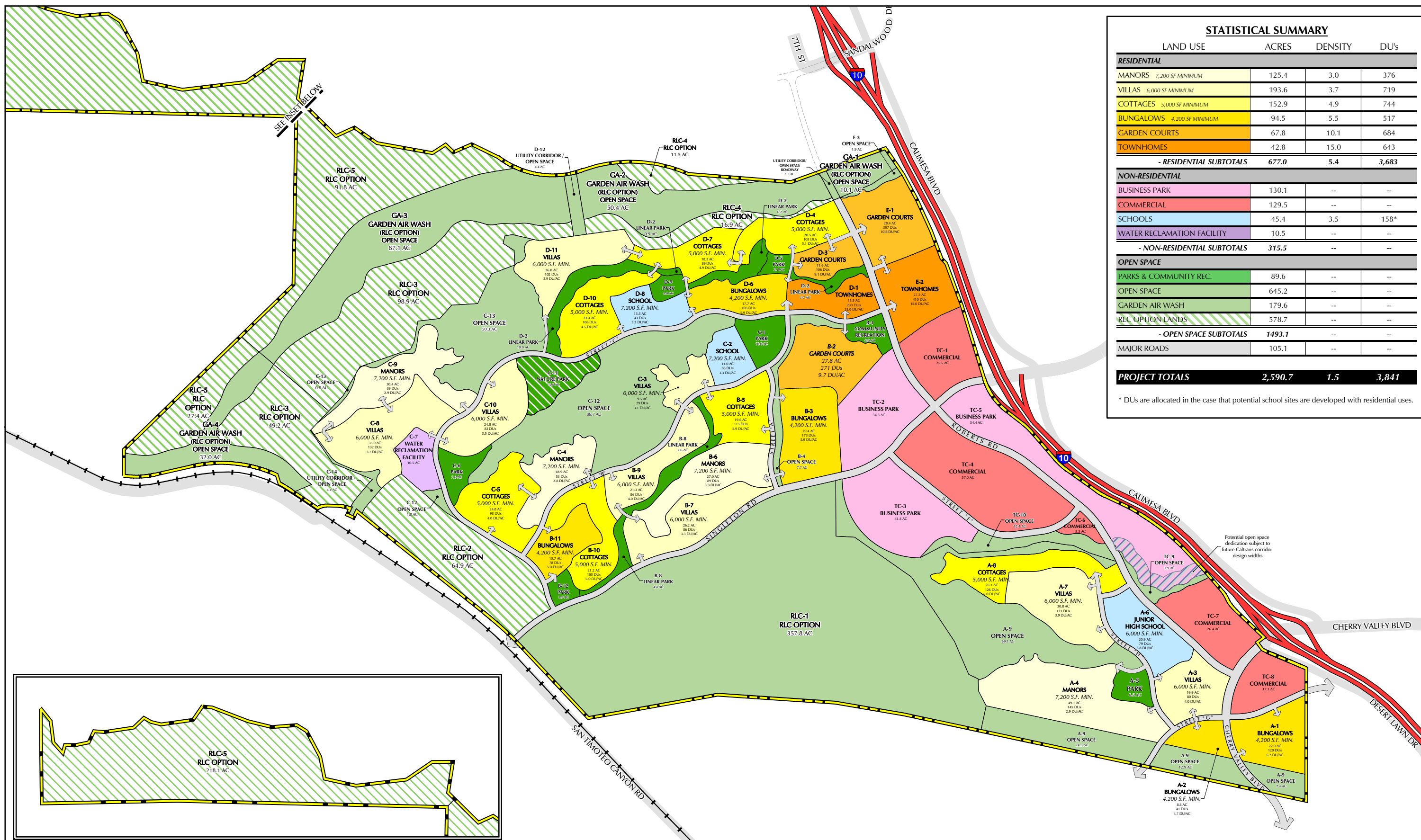

STATISTICAL SUMMARY			
LAND USE	ACRES	DENSITY	DU's
RESIDENTIAL			
MANORS 7,200 SF MINIMUM	125.4	3.0	376
VILLAS 6,000 SF MINIMUM	193.6	3.7	719
COTTAGES 5,000 SF MINIMUM	152.9	4.9	744
BUNGALOWS 4,200 SF MINIMUM	94.5	5.5	517
GARDEN COURTS	67.8	10.1	684
TOWNHOMES	42.8	15.0	643
- RESIDENTIAL SUBTOTALS	677.0	5.4	3,683
NON-RESIDENTIAL			
BUSINESS PARK	130.1	--	--
COMMERCIAL	129.5	--	--
SCHOOLS	45.4	3.5	158*
WATER RECLAMATION FACILITY	10.5	--	--
- NON-RESIDENTIAL SUBTOTALS	315.5	--	--
OPEN SPACE			
PARKS & COMMUNITY REC.	89.6	--	--
OPEN SPACE	645.2	--	--
GARDEN AIR WASH	179.6	--	--
RLC OPTION LANDS	578.7	--	--
- OPEN SPACE SUBTOTALS	1493.1	--	--
MAJOR ROADS	105.1	--	--
PROJECT TOTALS	2,590.7	1.5	3,841

* DU's are allocated in the case that potential school sites are developed with residential uses.

SUMMERWIND RANCH AT OAK VALLEY

FIGURE III-1

Table III-1
Detailed Land Use Summary

PLANNING AREA	ACRES	DENSITY	DU'S
VILLAGE A			
RESIDENTIAL			
MANORS (A-4)	49.1	3.0	145
VILLAS (A-3, A-7)	50.7	4.0	201
COTTAGES (A-8)	25.1	5.0	126
BUNGALOWS (A-1, A-2)	31.7	5.1	161
NON-RESIDENTIAL			
SCHOOL (A-6)	20.9	3.8	79*
OPEN SPACE/RECREATION			
PARK (A-5)	6.5	--	--
OPEN SPACE (A-9)	113.7	--	--
CIRCULATION			
SUB-TOTAL	311.7	2.3	712*
VILLAGE B			
RESIDENTIAL			
MANORS (B-6)	27.0	3.3	89
VILLAS (B-7, B-9)	47.5	3.6	172
COTTAGES (B-5, B-10)	40.8	5.4	220
BUNGALOWS (B-3, B-11)	45.1	5.6	251
GARDEN COURTS (B-2)	27.8	9.7	271
OPEN SPACE/RECREATION			
PARKS AND COMMUNITY RECREATION (B-1, B-8, B-12)	21.9	--	--
OPEN SPACE (B-4)	7.7	--	--
CIRCULATION			
SUB-TOTAL	250.3	4.0	1,003
VILLAGE C			
RESIDENTIAL			
MANORS (C-4, C-9)	49.3	2.9	142
VILLAS (C-3, C-8, C-10)	69.4	3.5	244
COTTAGES (C-5)	24.8	4.0	98
NON-RESIDENTIAL			
SCHOOL (C-2)	11.0	3.3	36*
WASTEWATER TREATMENT FACILITY (C-7)	10.5	--	--
OPEN SPACE/RECREATION			
PARKS AND COMMUNITY RECREATION (C-1, C-6, C-11)	32.4	--	--
OPEN SPACE (C-12, C-13, C-14)	143.7	--	--
CIRCULATION			
SUB-TOTAL	356.6	1.5	520
VILLAGE D			
RESIDENTIAL			
VILLAS (D-11)	26.0	3.9	102

COTTAGES (D-4, D-7, D-10)	62.2	4.8	300
BUNGALOWS (D-6)	17.7	5.9	105
TOWNHOMES (D-1)	15.5	15.0	233
NON-RESIDENTIAL			
SCHOOLS (D-8)	13.5	3.1	43*
OPEN SPACE/RECREATION			
PARKS AND COMMUNITY RECREATION (D-2, D-5, D-9)	28.8	--	--
OPEN SPACE (D-12)	4.4	--	--
CIRCULATION	4.6	--	--
SUB-TOTAL	184.3	4.8	889
VILLAGE E			
RESIDENTIAL			
GARDEN COURTS (E-1)	28.4	10.8	307
TOWNHOMES (E-2)	27.3	15.0	410
OPEN SPACE/RECREATION			
OPEN SPACE (E-3)	1.9	--	--
SUB-TOTAL	57.6	12.4	717
TOWN CENTER			
NON-RESIDENTIAL			
BUSINESS PARK (TC-2, TC-3, TC-5)	130.1	--	--
COMMERCIAL (TC-1,TC-4, TC-6, TC-7, TC-8)	129.5	--	--
OPEN SPACE/RECREATION			
OPEN SPACE (TC-9, TC-10)	16.0	--	--
CIRCULATION	37.2	--	--
SUB-TOTAL	312.8	--	--
RLC OPEN SPACE			
RLC PURCHASED			
RLC-1	357.8	--	--
GARDEN AIR WASH / RLC OPTION LAND			
GA-1	10.1	--	--
GA-2	50.4	--	--
GA-3	87.1	--	--
GA-4	32.0	--	--
RLC-2	64.9	--	--
RLC-3	98.9	--	--
RLC-4	16.9	--	--
RLC-5	337.3	--	--
SUB-TOTAL	1117.4	--	--
TOTAL	2,590.7	1.5	3,841

*Maximum number of dwelling units that can be developed if the school is not constructed.

b. Land Uses

The proposed land uses within SUMMERWIND RANCH AT OAK VALLEY are described as follows:

□ Residential Land Use

The residential planning areas consist of approximately 3,683 dwelling units on 677.0 acres (5.4 du/ac) or 26% of the Specific Plan Amendment's total acreage. The gross overall average density for the project is 1.5 du/ac. As stated above, the number of dwelling units and residential density may be increased to 3,841 and 1.5 du/ac, respectively, on 677.0 acres if one or more of the schools are not acquired. The residential planning areas will vary in density from 3.0 du/ac to 15.0 du/ac and will be pocketed among aesthetically pleasing natural open space, functional and varied park uses, and multi-purpose trail systems. The housing mix will range from detached single-family units on 4,200 to 7,200 square foot (s.f.) lots to multi-family units in the form of garden courts and townhomes.

▪ Low Density Land Use (2-4 du/ac)
Manors and Villas

Approximately 1,095 dwelling units will be developed on 319.0 acres (12.3% of project area) at a low density land use. The low density residential units will be developed at an overall density of 3.4 dwelling units per acre, with lot sizes ranging between 7,200 s.f. for the Manors and 6,000 s.f. for the Villas. The low density development will be located in Villages A through D (See Figure IV-2, *Residential Site Plan Concept - Manors and Villas*). Low density residential land use is intended to provide areas for single-family, large lot subdivisions and will primarily be developed in the hilly and/or steeper sloped terrain of the site. This land use allows for design flexibility and minimizes the disruptions of grading and vegetation removal through selective building site location. In this manner, much of the visual and environmental resources of the site will be protected.

▪ Low Medium Density Land Use (4-7 du/ac)
Cottages and Bungalows

Approximately 1,261 dwelling units will be developed on 247.4 acres (9.5% of project area) at a low medium density land use. The low medium density residential dwelling units will be developed at an overall density of 5.0 dwelling units per acre, with lot sizes ranging between 5,000 s.f. for the Cottages and 4,200 s.f. for the Bungalows. The low medium density development will be provided in Villages A through D. Low medium density residential land use is intended to provide areas for single-family medium lot subdivisions and will primarily be developed toward the interior portions of the site. This residential land use may incorporate design features such as zero-lot-lines in an effort to create more useable side and back yards (See Figure IV-3, *Residential Site Plan Concept - Cottages and Bungalows*).

▪ **Medium Density Land Use (7-14 du/ac)**
Garden Courts

Development under the medium density residential category is intended for the smaller, detached Garden Court homes. Approximately 684 dwelling units will be developed on 67.8 acres (2.6% of project area) at a medium density land use. Medium density residential units will be developed at a density of 10.1 dwelling units per acre in Villages B, D, and E (See Figure IV-4, *Garden Court Site Plan Concept*). Garden Court homes will typically consist of four to six detached units clustered around a common driveway (or court), each with private patios or small yards. Due to the larger concentration of homes within this land use, medium density land uses will be located in close proximity to the I-10 freeway and the Town Center.

▪ **High Density Land Use (14-20 du/ac)**
Townhomes

Approximately 643 dwelling units will be developed on 42.8 acres (1.7% of project area) at a high density land use. The development will occur at a density of 15.0 dwelling units per acre in Villages D and E (See Figure IV-5, *Townhome Site Plan Concept*). This density category allows for a higher residential building intensity to occur adjacent to commercial areas and major transit routes. Accordingly, the townhomes will be located near the I-10 freeway and the Town Center.

In an effort to address the City of Calimesa’s affordable housing needs, a minimum of 150 townhomes shall be built at a size below 1,000 square feet. The required total of these units shall be built in one or both of Planning Areas D-1 or E-2, which are designated as High Density Land Use Townhomes on the Specific Plan Land Use Plan.

□ **Commercial Land Use**

Of the 315.5 acres of non-residential land use contained in SUMMERWIND RANCH AT OAK VALLEY, 129.5 acres (5.0% of project) will be designated for commercial land uses. Commercial land uses will be located in the proposed Town Center adjacent to the I-10 corridor (see Figure IV-20, *Commercial Site Plan Concept*). As described in greater detail in *Section IV, Design Guidelines*, in order to address aesthetic impacts along I-10, special landscape buffers will be provided in commercial planning areas closest to the freeway. Commercial uses are conveniently located and easily accessible for residents at the neighborhood level, thereby minimizing the amount of travel and distance for daily activities. The Town Center provides space for community-level retail and commercial services, as well as community and government facilities. Commercial retail services that are associated with a regional employment center such as hotels, restaurants, and ancillary facilities, also will support the residents of SUMMERWIND RANCH AT OAK VALLEY. These commercial uses will contribute to a jobs-housing balance within the community and the City of Calimesa. To accommodate future market conditions, residential units may be horizontally or vertically integrated into the commercial land use planning areas. This will create the opportunity to create a dynamic, mixed-use Town Center where people can live, work, and shop.

❑ Business Park Land Use

Within the Town Center, three business park planning areas will be developed on 130.1 acres (5.0% of project) adjacent to commercial land uses and the I-10 corridor (See Figure IV-21, *Business Park Site Plan Concept*). These planning areas are intended to provide areas for business and light industrial uses. These types of land uses will support and be compatible with the commercial uses that will develop within the proposed Town Center. The employment opportunities that these uses create will address demands created by both the residents of SUMMERWIND RANCH AT OAK VALLEY and the region. The business park uses will contribute to a jobs-housing balance within the community and the City of Calimesa. Similar to the commercial uses, residential units may be horizontally or vertically integrated into the business park land use planning areas, adding to the future possibilities of creating a dynamic, mixed-use Town Center.

❑ Public Facility Land Use

▪ Schools

Amendment No. 1 provides for three school sites dispersed throughout the community on a total of 45.4 acres (1.8% of project). A 20.9 acre middle school may be developed within residential neighborhoods centrally located in Village A. Additional potential school sites are located on 11.0 acres in Village C and 13.5 acres in Village D in the central portion of SUMMERWIND RANCH AT OAK VALLEY. Schools and parks will be strategically located to allow sharing of recreational and open space amenities. *[Note: If the School District elects not to acquire a school site, the site may be developed with the single-family residential units indicated on the land use plan. The total number of additional residential units will not exceed 158 units.]*

▪ Water Reclamation Facility

The Yucaipa Valley Water District (YVWD) proposes to construct a 12 MGD Wastewater Treatment Facility on a 10.5 acre site located within Village C. The facility will be constructed in four separate units of 3 MGD each to a build out capacity of 12 MGD ultimately designed to receive wastewater from this project and other proposed projects. In order to reduce dependency on the potable water supply, provide an economical source of landscape irrigation water, and possibly reduce the size and cost of potable water system infrastructure, it is proposed that water from the District's proposed Water Reclamation Facility be utilized for landscape areas. A system of tanks and pumps will be designed to receive treated water from the on-site facility and distribute it throughout the project. Parks, parkways, and other public permanently irrigated landscaped areas will utilize this water source.

c. Land Use Development Standards

To ensure the orderly and sensitive development of land uses proposed for SUMMERWIND RANCH AT OAK VALLEY, special standards have been created for each village. These area-specific standards will assist in efficiently implementing the proposed land division. In addition to these specific guidelines,

project-wide development standards also have been prepared which complement the diverse conditions within each village.

The proposed number of dwelling units contained in an implementing subdivision application may exceed the maximum units specified in any one planning area by not more than fifteen percent without an amendment to this plan, provided that either an equal or greater number was unused in a previously or concurrently approved application within another planning area or an equal or greater number is subtracted from a future planning area, or a combination of the two. In no case shall the total number of dwelling units exceed 3,683, or 3,841 in the event the School District elects not to utilize a school site. Nothing contained herein shall limit the authority of the Planning Commission or City Council to reduce the number of dwelling units requested in an application.

If a transfer of dwelling units is proposed, the Master Developer or his Assignee shall be responsible for providing the City with a Development Transfer Status Report at the time that implementing subdivisions are submitted. This report will specify the entitlement and development status of each planning area including the following information:

- a. Specific Plan Amendment Planning Area allocation of dwelling units.
- b. Number of dwelling units entitled under an Implementing Subdivision by Planning Area.
- c. Number of dwelling units transferred to or from each Planning Area that is already entitled or proposed to be entitled with an implementing subdivision.
- d. Number of dwelling units transferred to or from each Future Planning Area that is proposed to be entitled with an implementing subdivision
- e. Environmental impacts associated with the transfer, if any, that were not fully addressed in EIR No. 418.

The Development Transfer Status Report must demonstrate that the total number of dwelling units for the project will not exceed 3,841 and that the total number of dwelling units to be entitled within any particular Planning Area will not exceed its Specific Plan Amendment allocation by more than 15%. Dwelling units may not be transferred out of a Planning Area unless an implementing subdivision is approved (previously or concurrently) for that Planning Area. The City shall not approve any transfer of dwelling units between Planning Areas unless the Developer submits a Development Transfer Status Report with the application for an implementing subdivision.

The total Specific Plan Amendment No. 1 area shall be developed with a maximum of 3,841 dwelling units on 2,590.7 acres, as illustrated in Figure III-1, *Specific Land Use Plan*. General uses permitted will include residential, commercial, business park, public facilities, parks and recreation, and open space. A maximum number of dwelling units is specified for each village. In no case shall the total number of dwelling units within the SUMMERWIND RANCH AT OAK VALLEY Specific Plan Amendment No. 1 area exceed 3,841. In adherence to the City of Calimesa General Plan, the standards listed below will assist in efficiently implementing the proposed land use division.

- 1.) Uses and development standards shall be in accordance with the SUMMERWIND RANCH AT OAK VALLEY Zoning Ordinance and shall be further defined by Specific Plan Amendment

- objectives, the Specific Plan Amendment design guidelines, and future detailed development proposals including subdivisions, plot plans, and/or conditional use permits.
- 2.) As a requirement of the California Solid Waste Reuse and Recycling Act of 1991, SUMMERWIND RANCH AT OAK VALLEY shall provide adequate areas for collection and loading of recyclable materials in schools, the private recreation center, and residential areas.
 - 3.) Standards relating to signage, landscaping, parking, and other related design elements will conform to the SUMMERWIND RANCH AT OAK VALLEY Zoning Ordinance. When appropriate and necessary to meet the goals of this Specific Plan Amendment, the standards contained within this document will supersede the City of Calimesa's zoning ordinance requirements.
 - 4.) All project lighting shall be in accordance with applicable City of Calimesa standards.
 - 5.) Development of the property shall be in accordance with the requirements of all City of Calimesa ordinances, with the exception of oak tree preservation and hillside grading, which are defined by the SUMMERWIND RANCH AT OAK VALLEY Zoning Ordinance. This Specific Plan Amendment conforms with State laws.
 - 6.) Except for the Specific Plan Amendment Zoning Ordinance adopted concurrently with this Specific Plan Amendment, no portion of the Specific Plan Amendment which purports or proposes to change, waive, or modify any ordinance or other legal requirement for the development, shall be considered a part of the adopted Specific Plan Amendment.
 - 7.) Common areas identified in the Specific Plan Amendment shall be owned and maintained by the relevant maintenance organizations. The master property owners' association shall be charged with the unqualified right to assess their own individual owners who own individual units for reasonable maintenance and management costs which shall be established and continuously maintained. The property owners' association shall be responsible for parking, open space areas, signage, landscaping, irrigation, common areas, and other responsibilities as necessary. Specific responsibilities will be detailed in the EIR to this project.
 - 8.) A permanent master maintenance organization shall be established for the Specific Plan Amendment area to assume ownership and maintenance responsibility for all common open space, circulation systems, pedestrian and bicycle systems, and landscaped areas. The organization may be public or private. A merger with an area-wide or regional organization shall satisfy this condition provided that such organization is legally and financially capable of assuming the responsibilities for ownership and maintenance. If the organization is a private association, master/neighborhood associations shall be established for each residential development where required, and such associations may assume ownership and maintenance responsibility for neighborhood common areas.
 - 9.) Unless otherwise provided for in these standards, common areas shall be conveyed to the maintenance organization as implementing development is approved or any Schedule "I" or conveyance subdivision is recorded.

- 10.) The maintenance organization shall be established prior to, or concurrent with, approval of the first tract map or issuance of any building permit for any approved development permit. The ownership and maintenance responsibility shall be identified for each open space lot at the time Tentative Subdivision Maps are filed.
- 11.) Prior to issuance of a building permit for construction of any use contemplated by this Specific Plan Amendment approval, the applicant shall first obtain clearance from the City of Calimesa Planning Department verifying that all pertinent conditions of Specific Plan Amendment approval have been satisfied for the phase of development in question.
- 12.) A review in compliance with the California Environmental Quality Act (CEQA) shall be conducted to determine potential environmental impacts resulting from each tract, change of zone, plot plan, specific plan amendment, or any land use application required to implement the Specific Plan Amendment, unless said proposal is determined to be consistent with the Program EIR that accompanies this Specific Plan Amendment and does not require subsequent environmental documentation, or is exempt from the provisions of CEQA. The CEQA review shall be prepared as part of the review process for these implementing projects.
- 13.) Lots created pursuant to this Specific Plan Amendment and any subsequent tentative maps shall be in conformance with the development standards of the Specific Plan Amendment zone herein applied to the property.
- 14.) Development applications which incorporate common areas shall be accompanied by design plans for the common areas, specifying location and extent of landscaping, irrigation systems, structures, and circulation (vehicular, pedestrian, equestrian, and/or bicycle).
- 15.) If necessary, roadways, infrastructure, and open space may be coordinated by and paid for through an assessment or community facilities district or community service area to facilitate construction, maintenance and management.
- 16.) Final development densities for each planning area shall be determined through the appropriate development application up to the maximum density identified in the, Amendment No. 1, based upon but not limited to the following: a) adequate availability of services; b) adequate access and circulation; c) innovation in building types and design; d) sensitivity to landforms; e) sensitivity to neighborhood design through lot and street layouts; and f) minimum lot sizes as proposed by this Specific Plan Amendment.
- 17.) Areas designated as open space that will be conveyed within parcel boundaries to individual property purchasers shall be deed restricted so as to create open space easements and prohibit grading, construction, or other development activity in such open space.
- 18.) Designation, dedication, and/or payment of fees for parkland and open space will be based on the final number of dwelling units and corresponding population generated by SUMMERWIND RANCH AT OAK VALLEY and will satisfy both City and State requirements for parkland. The

acreage is set forth in Figure III-1, *Specific Plan Land Use Plan*, and Table III-1, *Detailed Land Use Summary*.

- 19.) Prior to the issuance of building permits, improvement and irrigation plans for adjacent common areas shall be submitted for Planning Department approval. Irrigation plans shall be prepared by a certified landscape architect.
- 20.) The following crime prevention measures shall be considered during site and building layout design for the security and safety of future residents:
 - a. Addresses which light automatically at night.
 - b. Special lighting requirements on any buildings that are grouped in such a way that individual addresses are difficult to read.
- 21.) Development within the project shall conform to Title 24, Chapter 2-71, of the California Administrative Code to ensure accessibility to handicapped individuals.
- 22.) The City of Calimesa will assist in establishing public facilities and infrastructure (such as sewer and water lines, and roadways) which shall be financed through an assessment district (AD), or a community facilities district (CFD). Financing of these facilities through a CFD may substitute for the payment of fees that would have financed those facilities.
- 23.) All water mains and fire hydrants providing required fire flows shall be constructed in accordance with the appropriate sections of the City of Calimesa Zoning Ordinance and/or subject to approval by the City of Calimesa Fire Department.

2. Open Space and Recreation

a. Description

Approximately 1,493.1 acres (57.6% of project area) will be devoted to open space and recreational uses. SUMMERWIND RANCH AT OAK VALLEY proposes a comprehensive system of managed open space for the purpose of preservation, conservation, and recreation. The majority of this vast open space is located in the rolling terrain found adjacent to the southern, eastern, and northern boundaries of Amendment No. 1 (See Figure III-2, *Open Space and Recreation Plan*). The 1,493.1 acres of open space and recreation land uses within SUMMERWIND RANCH AT OAK VALLEY consist of 645.2 acres (24.9% of project area) located within the Villages, 179.6 acres (6.9% of project area) of natural open space within the Garden Air Wash, and 578.7 acres (22.3% of project area) located within Riverside Land Conservancy (RLC) option lands. The remaining 89.6 acres (3.5% of project area) will be devoted to parks and community recreation. The overall project design is responsive to major natural and scenic features, retaining them within open space areas and incorporating them wherever feasible into parks, trails, and other recreational opportunities.

□ Open Space

Natural open space will be provided within all five Villages and The Town Center, most of which will be interlinked with one another. Due to the sensitive biological resources contained in the designated open space areas, access to these areas will be restricted to well-marked trail systems that traverse the community and connect with the regional trails identified in Figure III-2, *Open Space and Recreation Plan*. In many areas of SUMMERWIND RANCH AT OAK VALLEY, natural open space and ridgelines will act as a buffer between the proposed urban land uses and the more sensitive biological resources contained in the RLC acquired property and those areas that are under consideration for purchase and conservation by the RLC.

□ **RLC Option Lands**

Riverside Land Conservancy (RLC) is an organization dedicated to the conservation of open space and natural areas. The RLC entered into an option agreement with Oak Valley Partners to purchase approximately 1,112 acres of land in three phases, at a price significantly below fair market value. It is RLC's intention to set this land aside as permanent open space. The RLC has closed on the first phase of approximately 357.8 acres and plans to close on the balance of the acreage by the end of 2004. RLC Option Lands comprise a total of 758.3 acres,

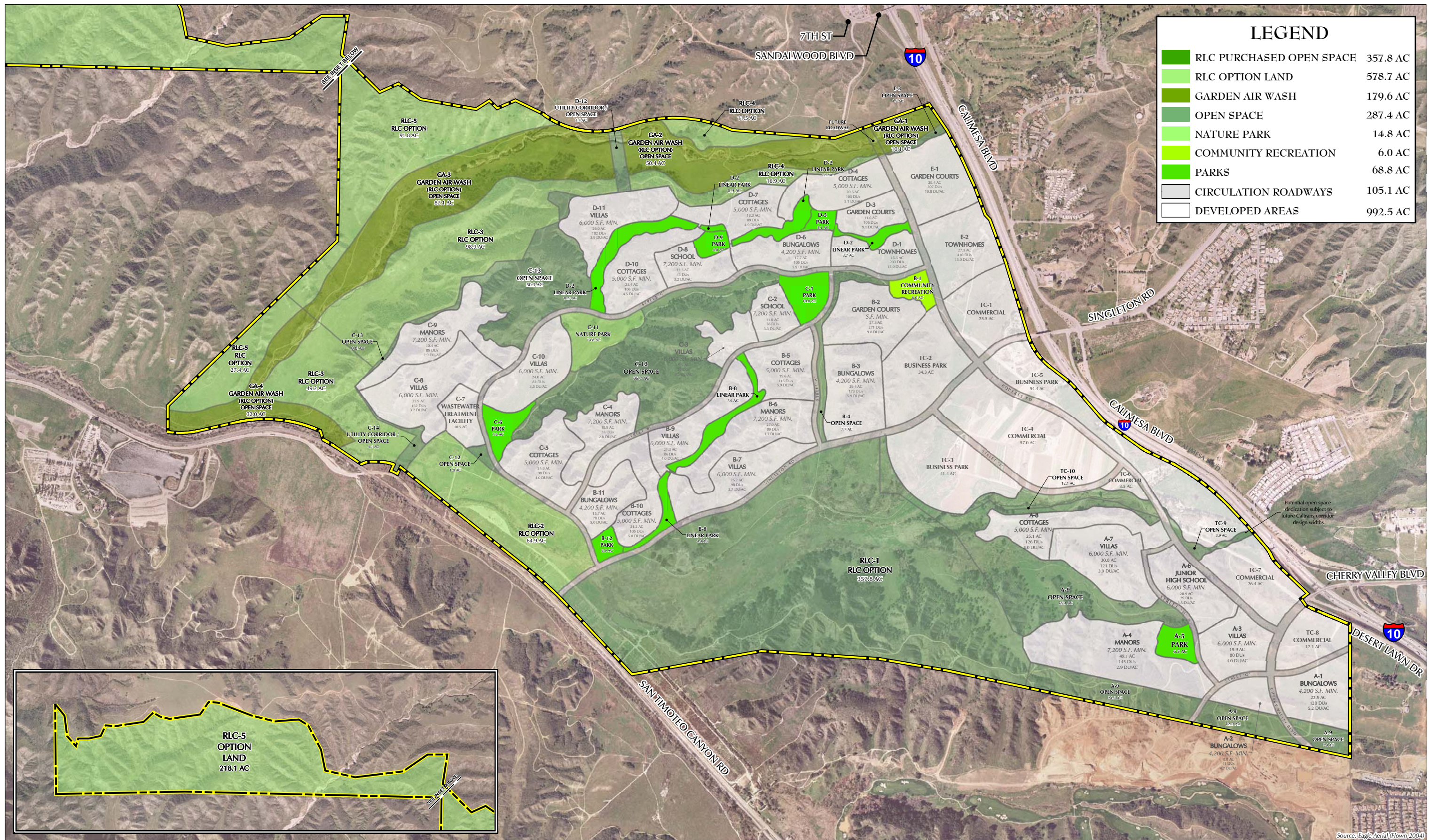

SUMMERWIND RANCH AT OAK VALLEY

FIGURE III-2

OPEN SPACE AND RECREATION PLAN

Specific Plan Area No. 1,
Amendment No. 1



consisting of 578.7 acres located on the outer boundaries of the villages and 179.6 acres of RLC Option Land in The Garden Air Wash to the north of the villages. Should the RLC fail to acquire the remaining property, the property will be offered to the City of Calimesa for acquisition pursuant to an MSHCP fee credit agreement. If the City of Calimesa chooses not to acquire the property, 179.6 acres of the Garden Air Wash will be designated as open space and the balance of the acreage will be available for development. If the RLC does not accept the affected Planning Areas for conservation purposes, the land may be developed with the uses approved under the original Specific Plan Area No. 1 by means of preparing and amending this Specific Plan Amendment No. 1. Any amendment to this Specific Plan Amendment No. 1 is subject to a subsequent CEQA review process.

❑ **Garden Air Wash**

Regional wildlife movement will be accommodated through on-site preservation of the Garden Air Wash corridor. The corridor will provide a broad and functional link through the project site as part of a larger regional connection between the Badlands and the foothills of the San Bernardino Mountains. The corridor and adjoining open space will encompass diverse habitats used by native species of the Specific Plan Amendment area and region. As previously stated, should the RLC or the City of Calimesa decide not to acquire the parcels in this area, Garden Air Wash will be set aside as open space.

❑ **Parks and Community Recreation**

SUMMERWIND RANCH AT OAK VALLEY will provide 89.6 acres of parks and community recreation land uses for the enjoyment and well-being of all residents. Amendment No. 1 provides for a variety of parks consisting of active, passive, linear, and a nature park. In addition, a community recreation center will be developed on 6.0 acres in Village B. Park areas are designed with sensitivity to the natural topography of the project area and will be dispersed on a total of 83.6 acres throughout SUMMERWIND RANCH AT OAK VALLEY.

▪ **Active and Passive Parks**

As depicted in Figure III-3, *Active Park Concept*, the active parks may contain the following features: basketball courts, baseball/softball diamonds, basketball courts, tot lots, parking areas, comfort stations, picnic areas, and oak groves. The passive parks may contain open play lawn areas, par stations (exercise stations), shade structures, and picnic areas. (See Figure III-4, *Passive Park Concept*).

▪ **Linear Parks**

Linear parks will provide a convenient and aesthetically pleasing linkage for residents to walk and bike to activity areas throughout the community. As depicted in Figure III-5, *Linear Park Concept*, the linear parks located within Village B and D will link to active and passive parks and will contain pocket parks, par courses (exercise stations), passive use areas, and paseo trails. The 12.0 acre linear park located in Village B will provide a direct link between the



Legend

Symbol	Description
	Large canopy tree
	Ornamental / shade tree
	Existing Tree
	Residential lot
	Preserved Oak Grove
	Existing Open Space
	Shrub planting
	Turf
	Asphalt
	Trail Head Monument

Description

Design Guidelines

This active park will connect to the phase 1 linear park, tying into the community trail system. An existing oak grove on the southern portion of the site will be preserved. The site amenities shall include two basketball courts, a softball field, tot lots accommodating kids of all ages, and ample picnic and passive use areas.

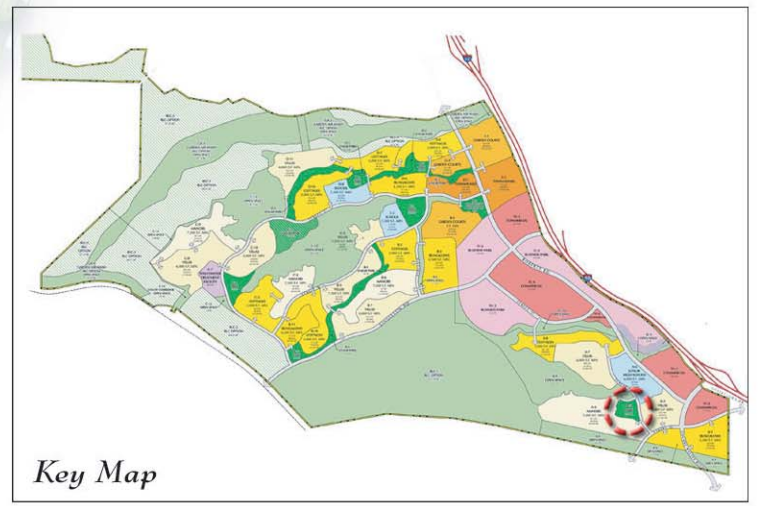

Key Map

Source: VanDyke

SUMMERWIND RANCH AT OAK VALLEY

Specific Plan Area No. 1,
Amendment No. 1



**FIGURE III-3
Active Park Concept**

Key Map

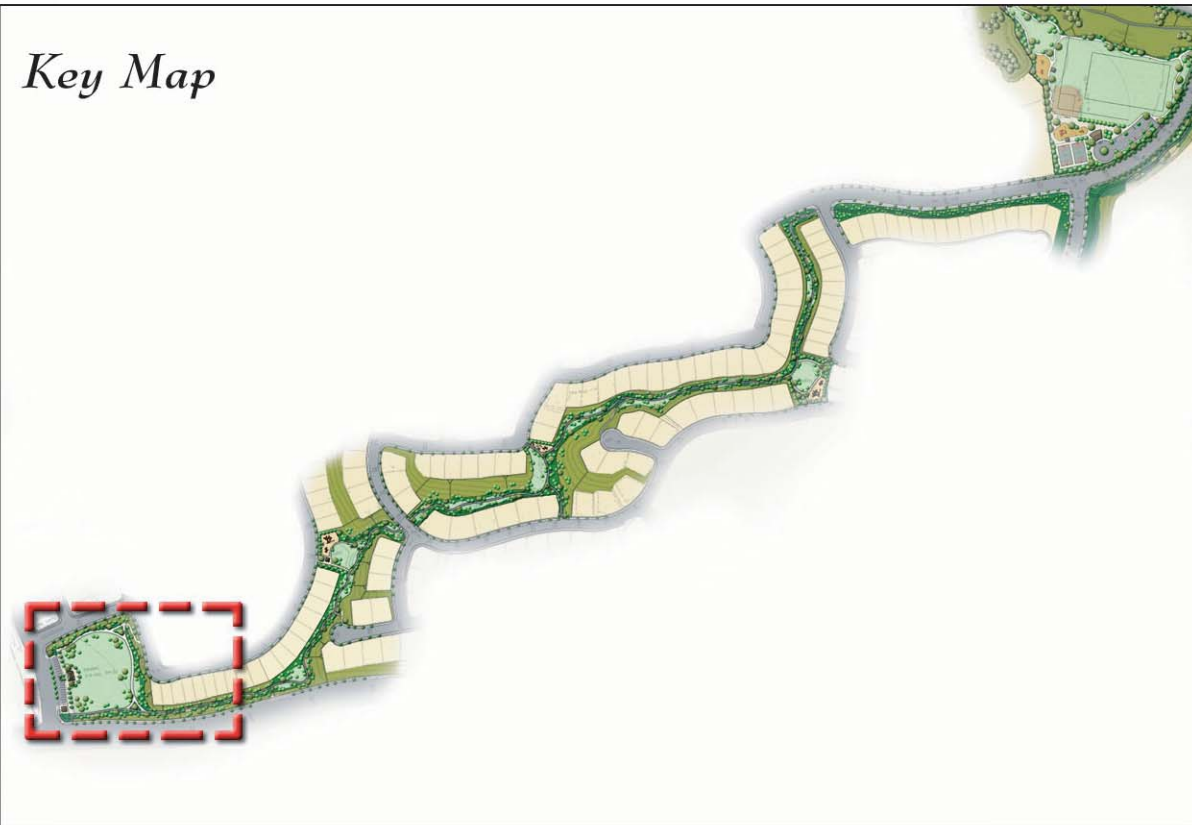

Legend

Symbol	Description
	Large canopy tree
	Ornamental / shade tree
	Residential lot
	Slope Treatment
	Shrub planting
	Turf
	Asphalt
	Trail Head Monument

Description

Design Guidelines

Located nearest the minor entrance to the community, this park will act as the starting point to the phase 2 linear park. The par course, which will continue throughout the community parks and trail system, will start in this park. The park will primarily be of passive uses, a grand lawn area is surrounded by more vegetated picnic areas.



SUMMERWIND RANCH AT OAK VALLEY

Specific Plan Area No. 1,
Amendment No. 1



Source: Van Dyke

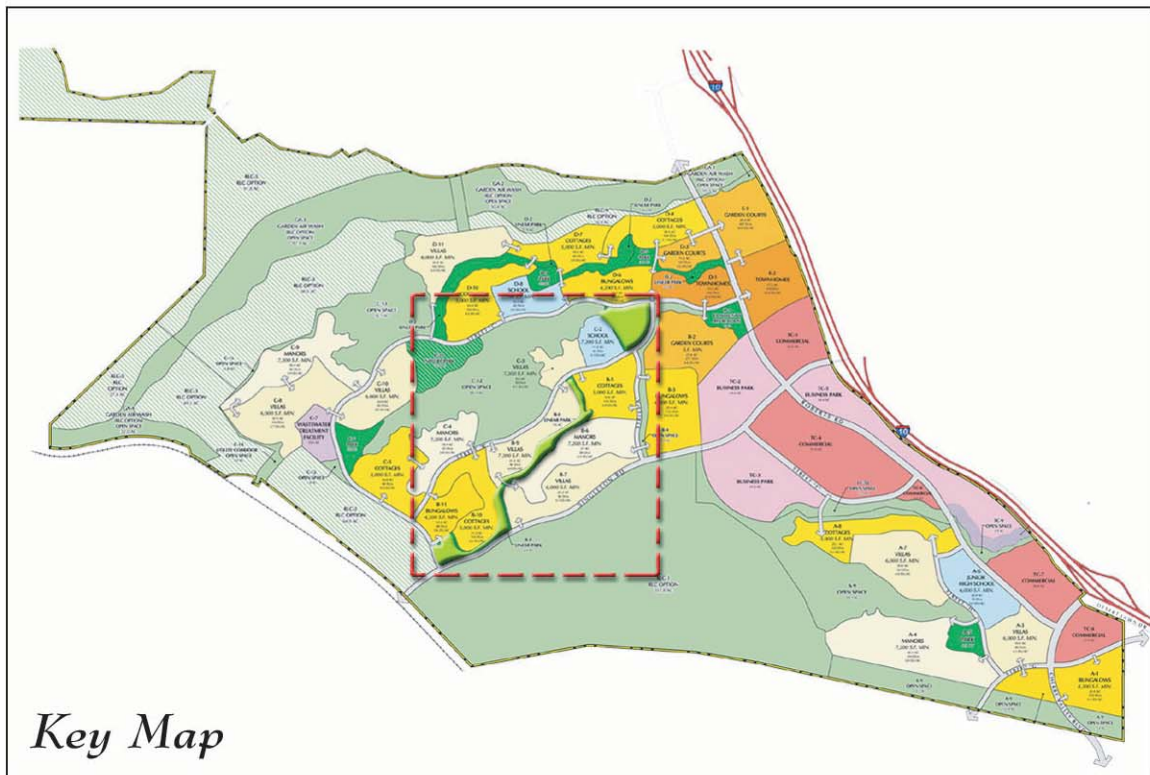

Key Map

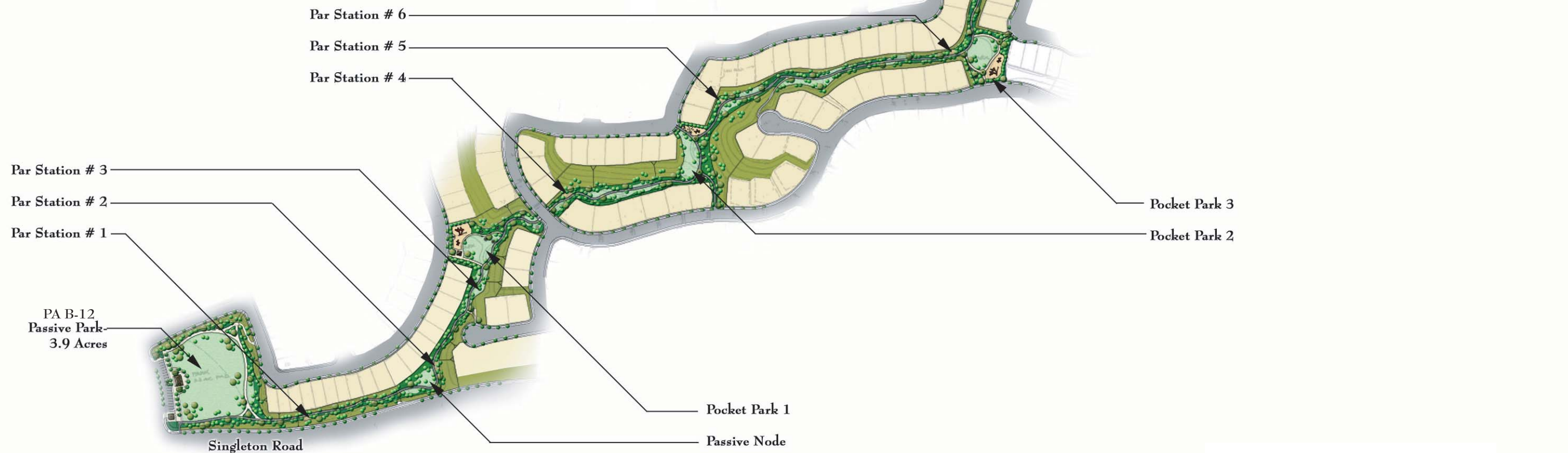

Source: Van Dyke

SUMMERWIND RANCH AT OAK VALLEY

Specific Plan Area No. 1,
Amendment No. 1



villages, open space, and the school located in Village C. The 21.7-acre linear park located in Village D will not only provide a link between pocket parks, the nature park, and the school site located in this village, it will also provide direct access to the open space in Village C.

▪ **Nature Park**

As depicted on Figure III-6, *Nature Park Concept*, a nature park will be centrally located on approximately 14.8 acres in Village C. The nature park will provide the residents of SUMMERWIND RANCH AT OAK VALLEY the opportunity to walk through natural areas such as a native plant garden, scenic overlooks, non-irrigated meadows, and oak groves. The nature park may also contain amenities such as picnic areas, a parking area, information kiosks, and pedestrian trails. The trails within the nature park will provide access to adjacent open space, ridgelines, and trail overlooks, providing residents a scenic view of the community and natural open space areas.

▪ **Community Recreation Center**

A private community recreation center consisting of approximately 6.0 acres will be located in Village B. Vehicular access will be provided via Street “C” and parking will be provided on-site. Residents may also access the community recreation area via paseos located adjacent to the recreation center. The community recreation center will allow for a wide array of active and passive uses provided for the enjoyment of community residents. Such amenities may include an indoor gym, lounge area, fire pits, swimming pools, spa, cabanas, water play area, basketball courts, tot lot, and a lawn and garden area, and a preserved oak grove (See Figure III-7, *Community Recreation Center Concept*).

b. Recreation Development Standards

- 1.) All recreation facilities will be landscaped and irrigated in a manner that is conducive to the type of plant material and landscape setting.
- 2.) Activity parks will include parking in accordance with City of Calimesa Standards.
- 3.) In accordance with the City of Calimesa’s implementation of the State's Quimby Act (Section 10.35 of Ordinance No. 460), the project is subject to fees for neighborhood and community park facilities. These fees shall be paid or facilities provided in lieu of fees for each dwelling unit constructed within the Specific Plan Amendment. Credit against these fees shall be granted by the City of Calimesa for all public parkland and improvements provided by the developer.

c. Open Space Development Standards

Landscaping within open space areas will be further governed by the development plans and standards in the Landscaping Plan in Section IV, *Design Guidelines*.



Legend

Symbol	Description
	Large canopy tree
	Ornamental / shade tree
	Oak tree
	Residential lot
	Slope treatment
	Non-Irrigated Meadow
	Shrub planting
	Asphalt
	Trail Head Monument

Description

Design Guidelines

The nature park shall be a drought resistant, wildlife oasis. Educational gardens and informational signs will be located throughout. There should be an ADA accessible trail system throughout the park, linking educational overlooks, nodes and the community trail system.

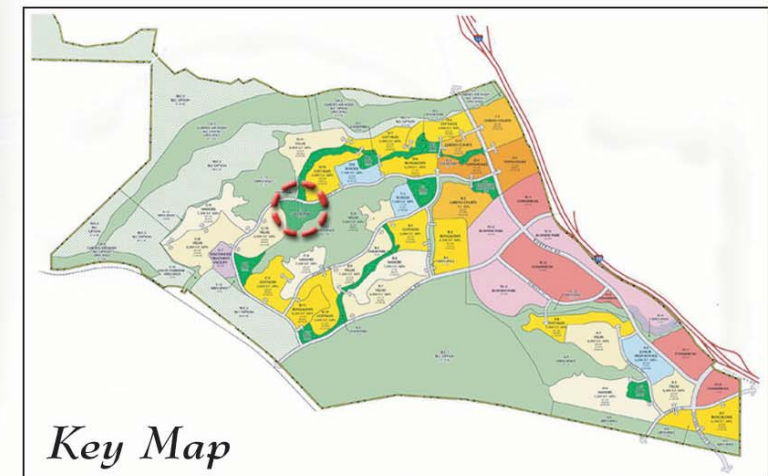

SUMMERWIND RANCH AT OAK VALLEY

Specific Plan Area No. 1,
Amendment No. 1



Source: Van Dyke

FIGURE III-6
Nature Park Concept

PAGE III-19

Connection to Active Park C

Asphalt Paseo

Garbage Enclosure

Street "C"

Monumentation Area

Drop Off

Parking Lot - 65 Spaces
(3 Handicapped)

Planting Area

Fire Pit

Gym

Deck

Roberts Road

Basketball Court

Lap Pool

Adult Play Pool

Kid's Pool

Lounge

Garden

Water Feature

Connection to Garden Courts

Trellis

Tot Lot

Screening Vegetation/
Preserved Open Space

Spa

Water Play

Cabana with Showers

Formal Gathering Area with Water Feature

Trellis

Lawn/Garden Area

Legend

Symbol	Description
	Existing Tree
	Large canopy tree
	Ornamental / shade tree
	Palm Tree
	Residential lot
	Slope treatment
	Shrub planting
	Turf
	Asphalt

Description

Design Guidelines

The community recreation center should act as a hub for all community activity. The center should include an aquatic center, tot-lots, lounge and reception areas, sport courts, lawn areas, exercise areas, and an administrative area. Parking should be on-site, all pathways and site amenities shall be ADA compliant. Roberts Road should be screened with dense vegetation and/or soundwalls. The existing oak grove and natural vegetation on the south portion of the site should be preserved as much as possible. The recreation center shall have access from the community paseo trail system.

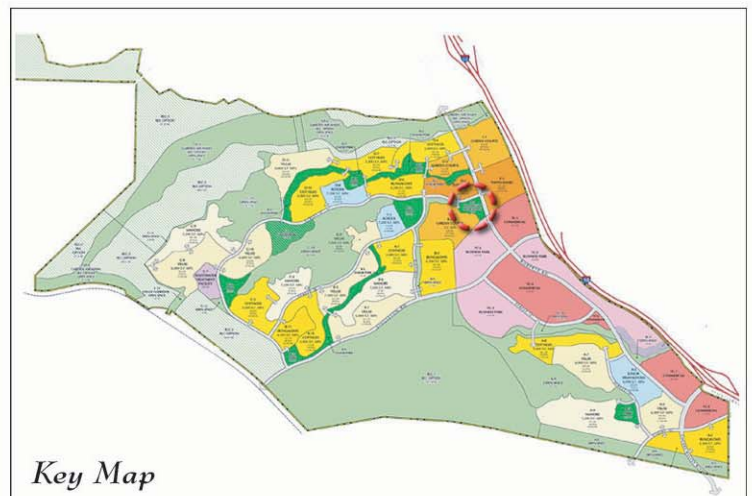

Key Map

SUMMERWIND RANCH AT OAK VALLEY

Specific Plan Area No. 1,
Amendment No. 1



Source: Van Dyke

FIGURE III-7

Community Recreation Center Concept

PAGE III-20

3. Circulation Plan

Vehicular

a. Description

The circulation plan for SUMMERWIND RANCH AT OAK VALLEY is strongly influenced by the topography of the site and the existence of Interstate 10 (I-10) and two interchanges. San Timoteo Canyon Road is a secondary design influence. Given these constraining factors, the backbone of the Specific Plan Amendment's circulation lies within the three dominant valleys (alluvial plains) that traverse the site from I-10 to San Timoteo Canyon Road. As shown in Figure III-8, *Circulation Plan*, Singleton Road (a General Plan Circulation Element Roadway) is designated as an Urban Arterial Roadway (134' ROW) from I-10 to Roberts Road. As it traverses east to west through the project site, the Singleton Road right-of-way (ROW) is reduced to an Arterial Roadway (110' ROW), and subsequently to a Secondary Roadway (88' ROW) as it approaches San Timoteo Canyon Road. Other Circulation Element roadways that traverse the Amendment No. 1 area include: Cherry Valley Boulevard, Roberts Road, and Street "C". These roadways, including Singleton Road, and Streets "A", "B", "C", "F", "G", and "H" will be improved per the alignments shown in Figure III-8 and the roadway classification standards outlined in Amendment No. 1. These circulation improvements require a General Plan Amendment to be approved concurrently with this Specific Plan Amendment to allow for changes to the roadway network contained in the City of Calimesa's Circulation Element. The proposed Circulation Plan will result in an effective roadway network that enhances quality of life, improves access to community services, and ensures mobility for residents, emergency personnel, and visitors alike.

b. Circulation Plan Development Standards

- 1.) The roadway segments identified on the Specific Plan Amendment's Circulation Plan shall be improved per the standards in Table III-2, *Roadway Standards* and the cross-sections depicted in Figure III-9, *Roadway Cross-Sections*.
- 2.) The developer(s) of SUMMERWIND RANCH AT OAK VALLEY shall provide a fair share contribution toward the improvements required at the Singleton Road/I-10 and Cherry Valley Boulevard/I-10 interchanges. This contribution requirement will be satisfied with the payment of Riverside County Transportation Uniform Mitigation Fees (TUMF).
- 3.) The developer(s) of SUMMERWIND RANCH AT OAK VALLEY shall construct Roberts Road as an arterial roadway that parallels the I-10 from the Garden Air Wash to Cherry Valley Boulevard. This arterial will connect to the existing frontage road east of Cherry Valley Boulevard. In some locations, the arterial will relocate the existing frontage road and shift this transportation corridor to the interior of the project site.
- 4.) Multiple driveways and intersections shall be provided along Roberts Road to accommodate safe and adequate vehicular access to the Town Center development area.
- 5.) The divided Collector/Arterial Highway intersections shall be expanded to accommodate turn bays and medians.

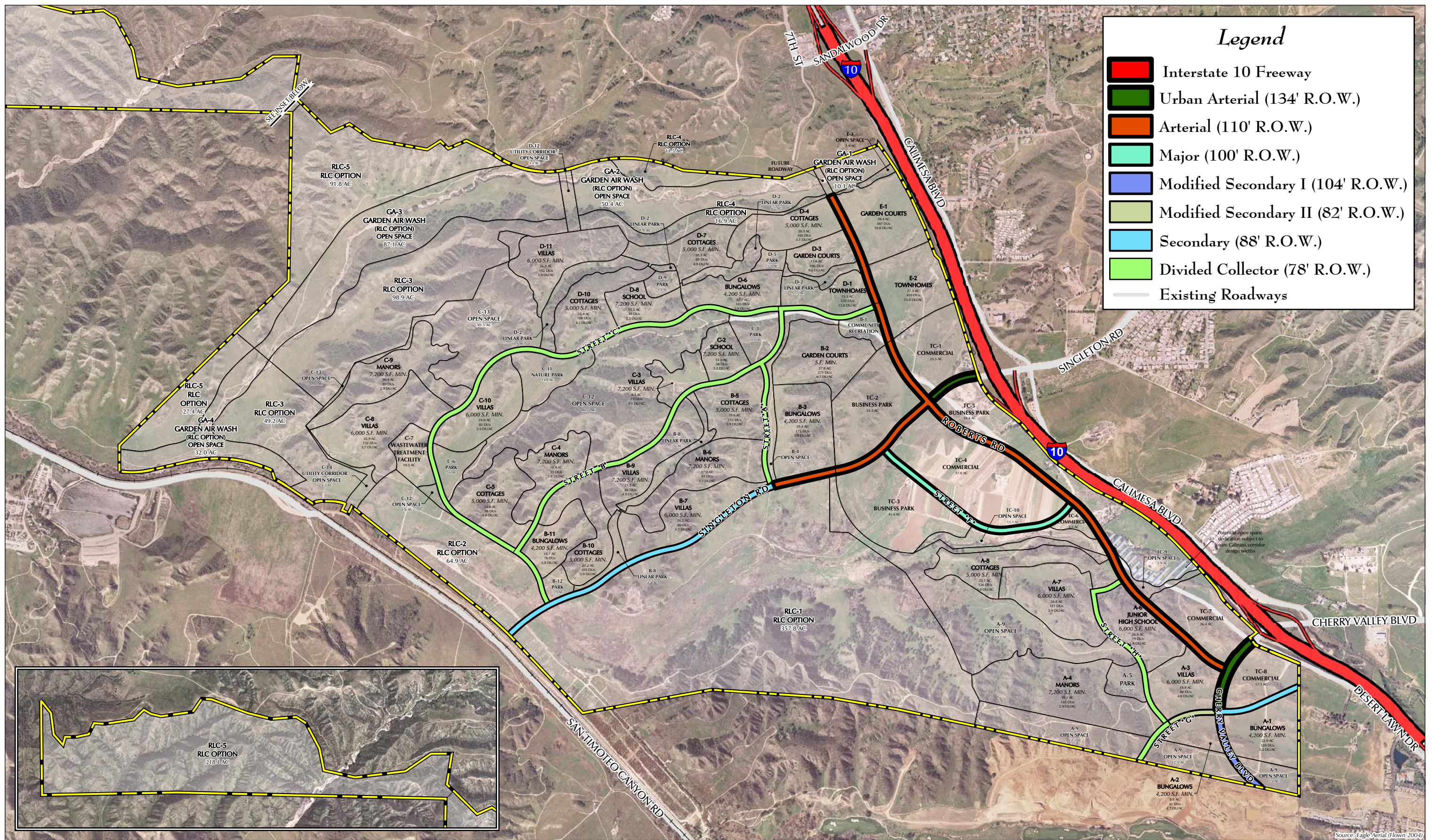

Legend

- Interstate 10 Freeway
- Urban Arterial (134' R.O.W.)
- Arterial (110' R.O.W.)
- Major (100' R.O.W.)
- Modified Secondary I (104' R.O.W.)
- Modified Secondary II (82' R.O.W.)
- Secondary (88' R.O.W.)
- Divided Collector (78' R.O.W.)
- Existing Roadways

SUMMERWIND RANCH AT OAK VALLEY

Specific Plan Area No. 1
Amendment No. 1

T&B PLANNING CONSULTANTS
17542 East 17th Street, Suite 100, Tustin, CA 92780
p. 714.305.6360 f. 714.305.6361
www.tbplanning.com

0 250 500 1,000
Feet

FIGURE III-8

CIRCULATION PLAN

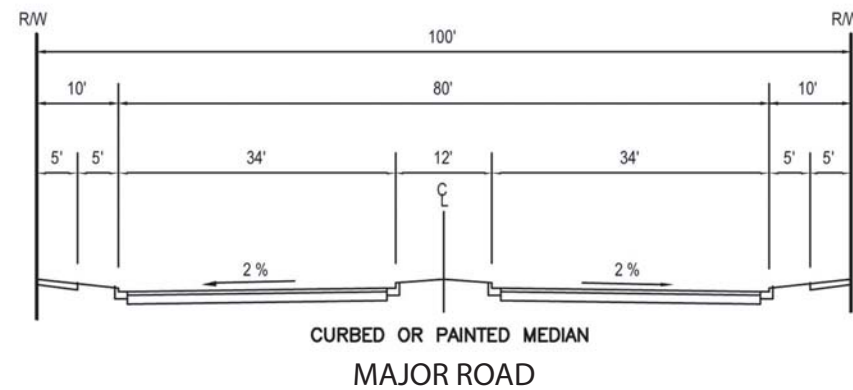
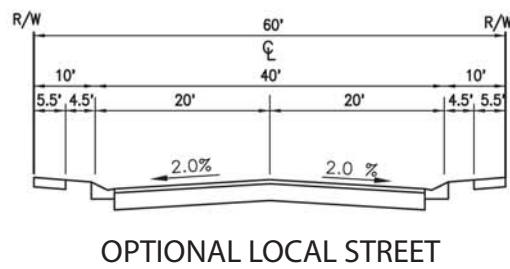
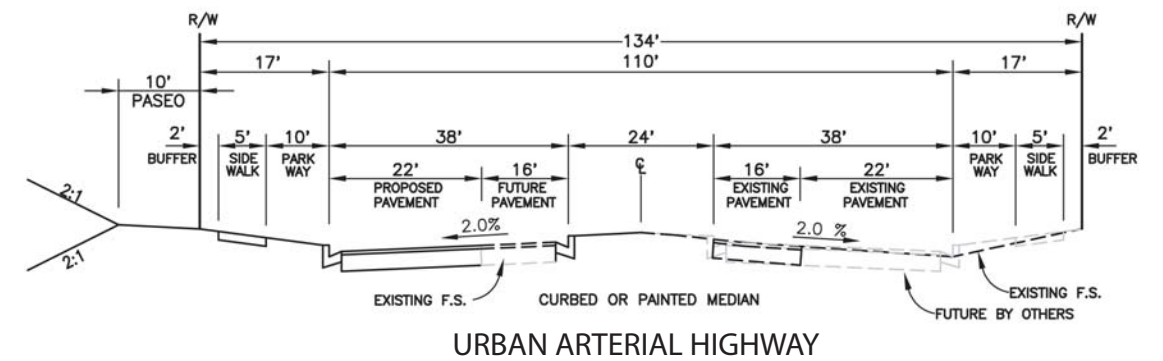
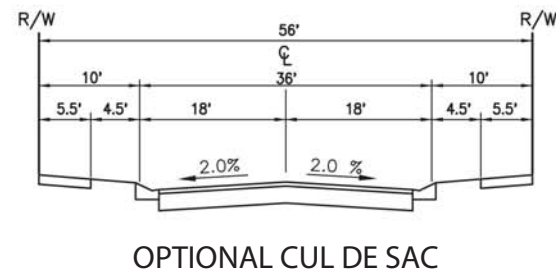
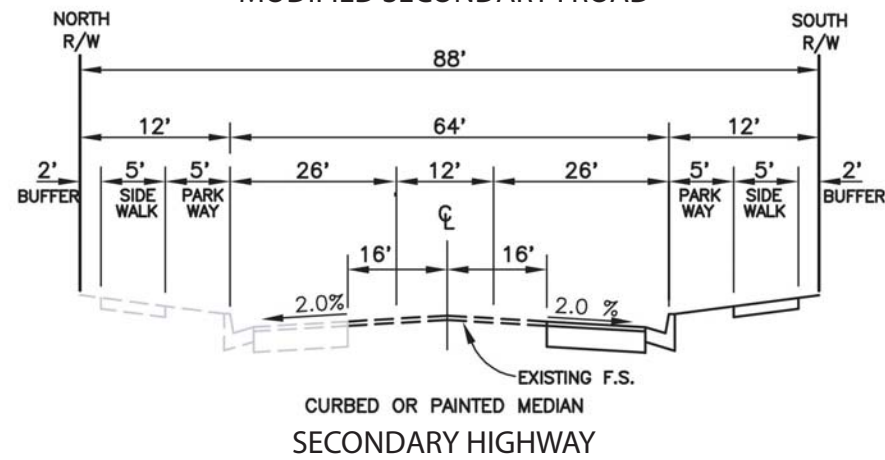
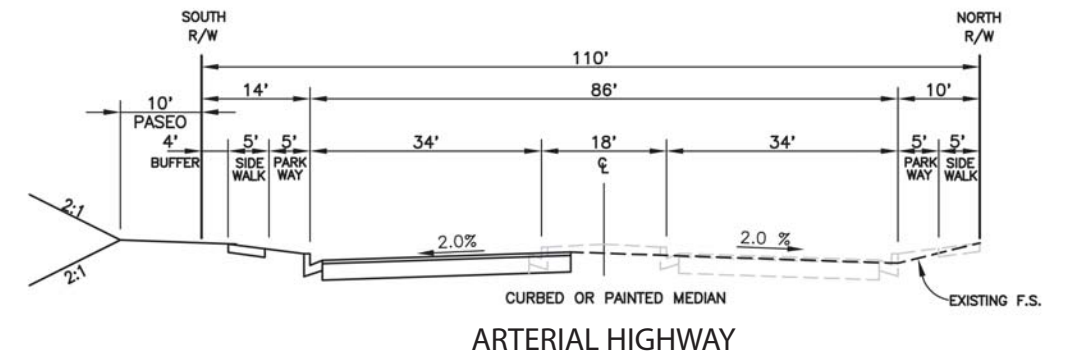
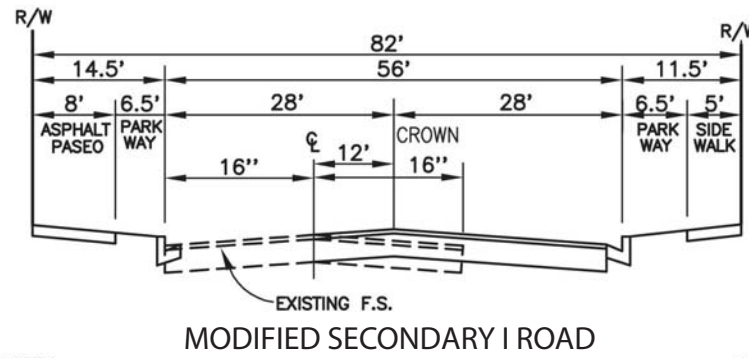
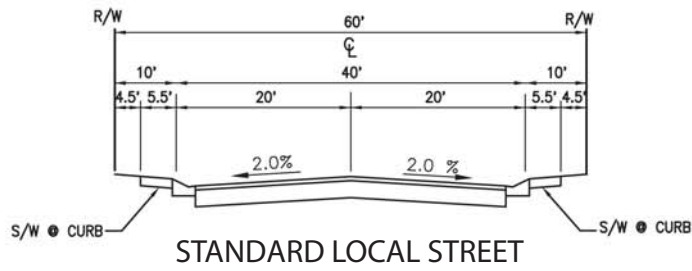
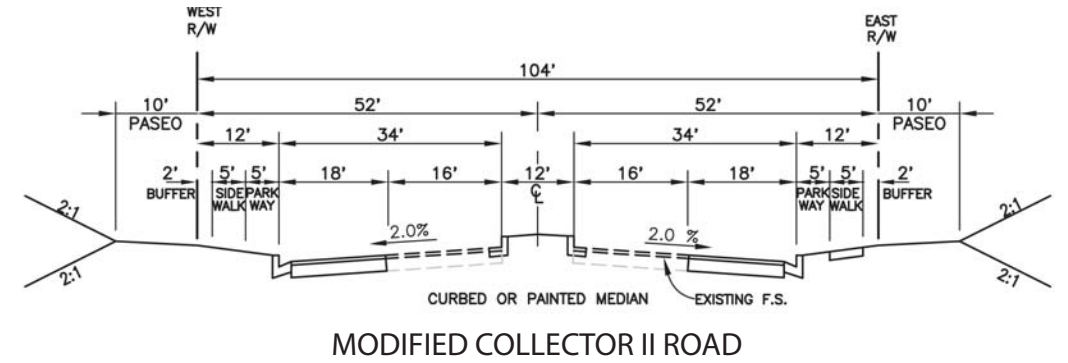
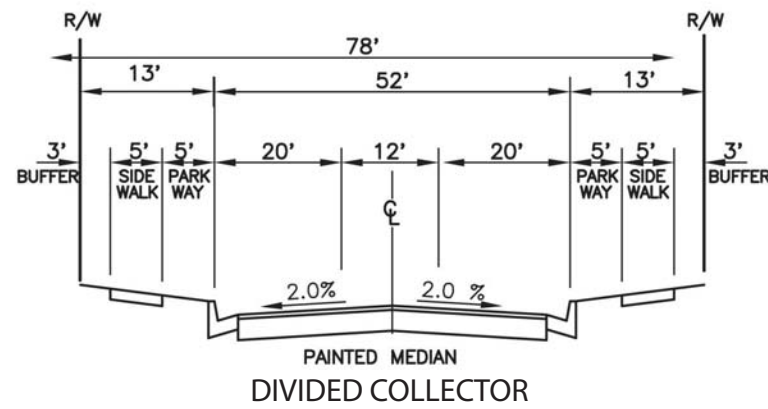
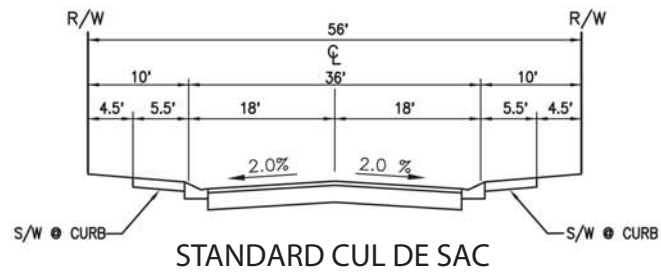

Source: The Keith Companies, VanDyke

SUMMERWIND RANCH AT OAK VALLEY

Specific Plan Area No. 1,
Amendment No. 1



FIGURE III-9 ROADWAY CROSS-SECTIONS STANDARDS

- 6.) Arterial roadways shall operate at a Level of Service “C” or better.
- 7.) Arterial roadways shall be offered to the City, prior to issuance of building occupancy permits.
- 8.) Landscape requirements, as further defined by the Development Phasing Plan, shall be in accordance with the Roadway Landscape Treatments depicted in Section IV, *Design Guidelines*.
- 9.) All roads within the SPA area shall be constructed to appropriate full or half-width standards as a requirement of the implementing subdivisions for the Specific Plan Amendment.
- 10.) Each planning area shall comply with on-site and off-site street improvement recommendations and mitigation measures outlined in the traffic analyses for this SPA and subsequent amendments.
- 11.) Corner cutbacks shall be included at all intersections of roads classified as Secondary or higher. A minimum curb return radius of 35 feet shall be provided at these intersections.
- 12.) Street gradients within the Specific Plan Amendment shall not exceed 12%.
- 13.) Local and cul-de-sac streets shall have curb adjacent; residential planning areas with lower densities (Manors & Villas only) shall have the option to separate sidewalks from the curb with a landscaped parkway. In residential neighborhoods, no less than one street tree shall be planted per interior lot and two per corner lot.
- 14.) Construction of sidewalks along local or cul-de-sac roads that are adjacent to natural open space areas shall be optional.

Table III-2
Roadway Standards

ROADWAY	SEGMENT	CLASSIFICATION	ROW
Singleton Road	I-10 to Roberts Road	Urban Arterial	134'
Singleton Road	Roberts Road to Street “A”	Arterial	110'
Singleton Road	Street “A” to San Timoteo Canyon Road	Secondary	88'
Cherry Valley Boulevard	I-10 to Street “G”	Urban Arterial	134'
Cherry Valley Boulevard	Street “G” to southern boundary	Modified Secondary I	104'
Roberts Road	Entire segment	Arterial	110'
Street “A”	Entire segment	Divided Collector	78'
Street “B”	Entire segment	Divided Collector	78'
Street “C”	Entire segment	Divided Collector	78'
Street “F”	Entire segment	Major	100'
Street “G”	Eastern boundary to Cherry Valley Parkway	Secondary	88'
Street “G”	Cherry Valley Parkway to Street “H”	Modified Secondary II	82'
Street “G”	Street “H” to southern boundary	Divided Collector	78'
Street “H”	Entire segment	Divided Collector	78'

Non-vehicular

Trails

a. Description

In an effort to provide connectivity throughout the community of SUMMERWIND RANCH AT OAK VALLEY, a comprehensive trail system is planned to connect residential neighborhoods to parks, schools, open space, and the Town Center. Trails throughout the community will be provided for pedestrians, equestrians, and bicyclists. As depicted in Figure III-10, *Trails System Plan*, trails will traverse through the villages of SUMMERWIND RANCH AT OAK VALLEY. In addition, many of the trails will provide the opportunity to connect to several off-site trails of regional significance.

☐ Equestrian Trails

SUMMERWIND RANCH AT OAK VALLEY will provide 6.5 miles of equestrian trails. Existing dirt trails traversing the natural open space areas within SUMMERWIND RANCH AT OAK VALLEY will provide a rugged terrain for horse-back riding, hiking and mountain biking. Equestrian trails adjacent to roadways will be comprised of decomposed granite. The equestrian trail located adjacent to Singleton Road will branch to the north at Street "A" through Villages B, C, and D and into the Garden Air Wash. In addition, the trail will branch to the south at Street "A" through RLC Option Lands where it will connect to an existing trail system. The equestrian trail will also travel north along the western project boundary where it will also provide a connection to the regional trail system and will travel northeast along the Garden Air Wash. Details of the trail's features are provided in Section IV, *Design Guidelines*. An additional equestrian trail will be provided in the southeastern portion of SUMMERWIND RANCH AT OAK VALLEY. This trail will provide equestrians with a ride through the community without the potential conflicts that occur with other user types (i.e. bicyclists, pedestrians, etc.). The goal of this trail type is to allow equestrian users full access through the community from existing trails to the south, to proposed equestrian trails in the north and east.

☐ Paseos

SUMMERWIND RANCH AT OAK VALLEY will provide its residents with 9.1 miles of pedestrian linkage throughout the SUMMERWIND RANCH AT OAK VALLEY community. Paseos will provide pedestrians and bicyclists convenient access to residential neighborhoods, parks, schools, and open space in the central portions of the community, and in the Town Center, while also traversing linear parks in Villages B and D. The paseo will connect more centrally located neighborhoods and amenities with Village A to the south. Passive amenities such as picnic tables, tot lots, and sitting benches will be conveniently located along the trail in Village A as it traverses the natural open space areas. Details of the trail's features are provided in Section IV, *Design Guidelines*.

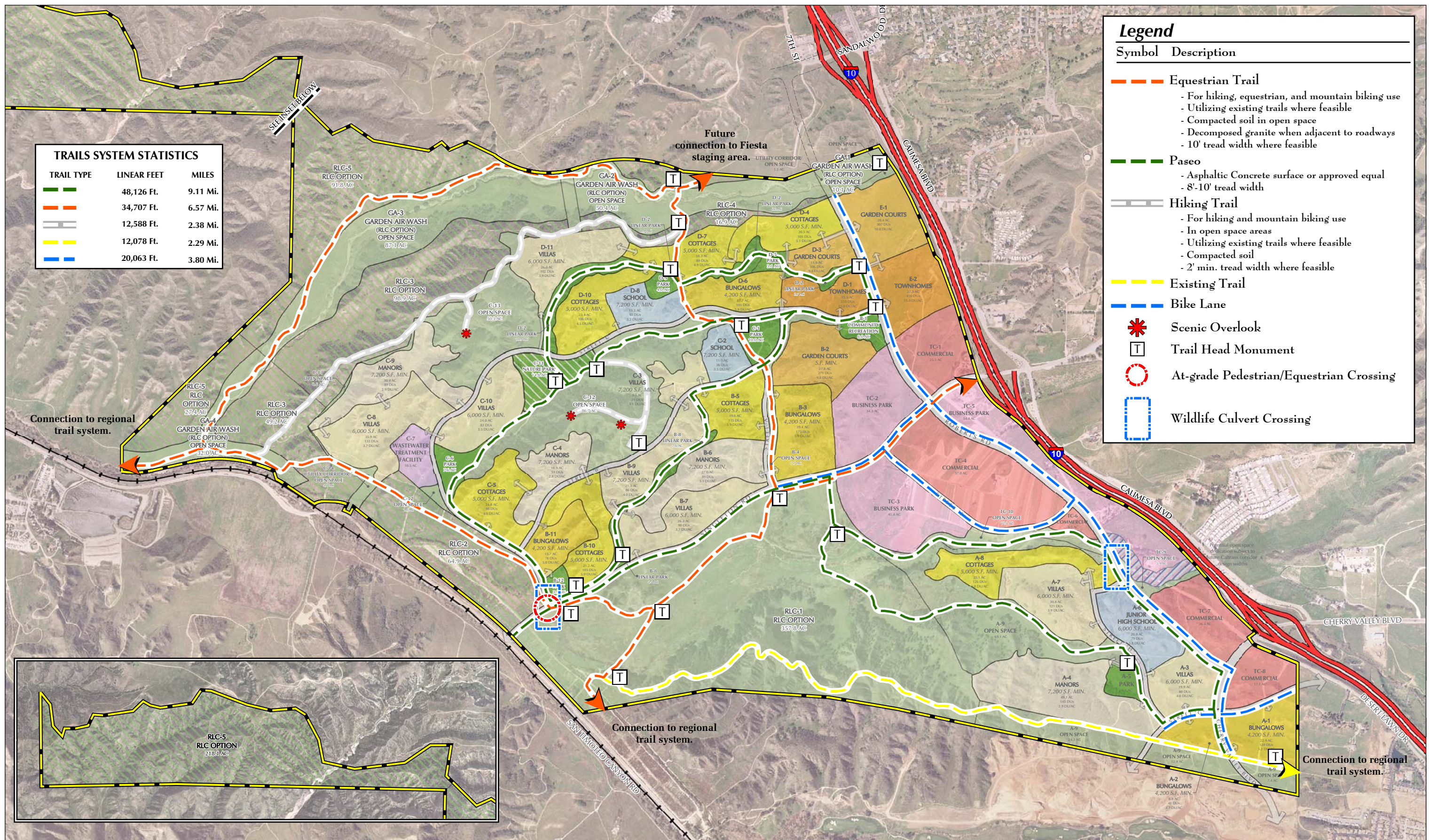

SUMMERWIND RANCH AT OAK VALLEY

Specific Plan Area No. 1
Amendment No. 1



FIGURE III-10
TRAILS SYSTEM PLAN

□ Hiking Trails

SUMMERWIND RANCH AT OAK VALLEY will also provide its residents with 2.4 miles of hiking trails. These hiking trails will provide recreation to hikers and to mountain bikers and will be composed of compacted soil, utilizing existing trails where feasible. A hiking trail will be located in the large open space area in Village C and will provide scenic overlooks from the highest elevation point within the community. In addition, a hiking trail is provided in the northern reaches of Village C, traversing manors, villas, and open space to the south, and the Garden Air Wash to the north. Details of the trail's features are provided in *Section IV, Design Guidelines*.

□ Bike Lanes

SUMMERWIND RANCH AT OAK VALLEY will offer 3.80 miles of on-street bike lanes. Bike lanes will be provided along Roberts Road, Singleton Road, Street "F", Street "G", and Cherry Valley Boulevard. The bike lanes will provide convenient connections to the surrounding regional network of trails and designated bike lanes and will provide residents with an alternative mode of transportation for both leisure and work commutes to and from the Specific Plan Amendment area.

b. Development Standards for Trails

All trails provided as a part of the Trails System Plan shall be developed pursuant to the Design Guidelines contained in *Section IV*.

4. Drainage**a. Description**

Several natural streambed areas are located within the project site. Broad alluvial plateaus are divided by steep sided, wide bottom ravines that serve as natural drainage courses. The overall drainage plan will be designed to perpetuate the natural drainage courses within the site (see Figure III-11, *Master Drainage Plan*). The proposed drainage system will utilize and incorporate natural channels into the ultimate storm drain system. On-site storm drains will outlet into the natural streambed areas. Grading design will strive to minimize grading within the major streambed areas. The circulation plan is designed to minimize road and utility crossings. In addition, arched culverts with natural bottoms will be used to cross natural drainage courses, wherever possible.

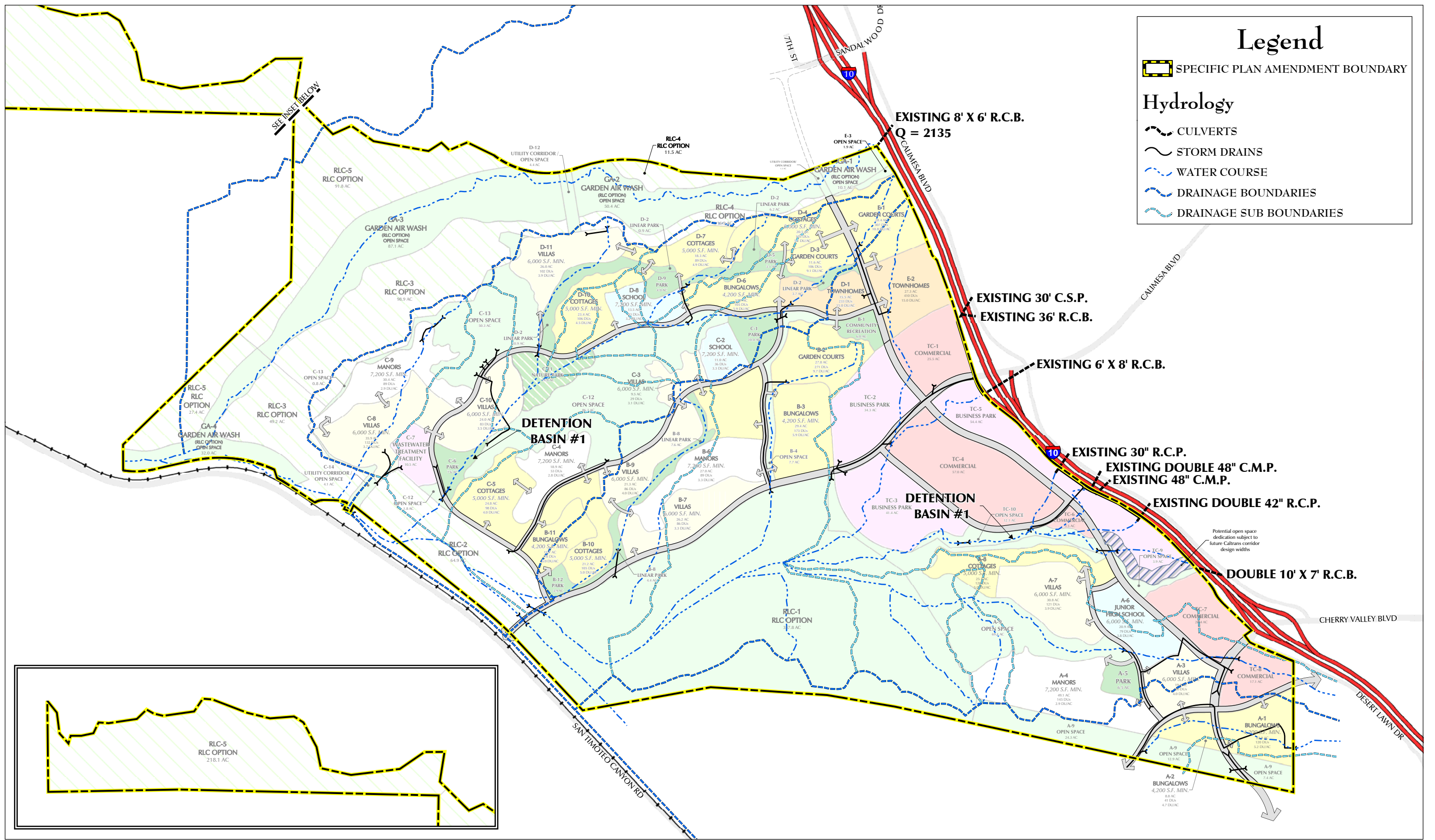

SUMMERWIND RANCH AT OAK VALLEY

FIGURE III-11

Specific Plan Area No. 1,
Amendment No. 1

The Keith Companies **TKC**
 TAB PLANNING CONSULTANTS
 www.tbplanning.com

0 250 500 1,000 Feet

MASTER DRAINAGE PLAN

The Garden Air Wash, designated as RLC Option Open Space, will not be significantly impacted by the proposed development. No grading or streambed alterations are proposed in the northerly watershed area with the exception of future road and utility pipeline crossing.

Two major drainage courses are located within the central portion of the project site. Drainage in the northern section originates completely within the project area and is carried in a natural streambed toward San Timoteo Creek. Short reaches of small diameter storm drains will be designed within this area to redirect storm flow into the natural stream. One of two detention basins is proposed for this area in order to mitigate the majority of first flush flows. The basin will be developed within the natural streambed area near the lower end of the natural area and will mitigate developed flows prior to release into San Timoteo Creek.

Existing culverts under the I-10 Freeway contribute storm water drainage into most of the southerly section of the project area. Developed flows will be picked up within a series of short reach storm drain systems. To mitigate first flush drainage prior to discharge into the open space area, a second detention basin is proposed within a portion of a natural streambed area. The size and depth of the basin will be designed to be compatible with the natural drainage course.

The natural drainage flows from within the project area confluence with upstream drainage flowing westerly parallel to and just east of the existing San Timoteo Canyon Road. These combined flows join prior to discharging into San Timoteo Creek. "Soft bottom" arched culverts will be used to cross the natural streambed areas so as to minimize disturbance and impact to the area. The two upstream detention areas will serve to mitigate "first flush" drainage prior to entering San Timoteo Creek.

Drainage from the southwest corner of the project site will be picked up and directed south into the SCE easement. Drainage facilities within the adjacent development area have been designed for ultimate developed flows as part of a project within the City of Beaumont. No detention facilities are proposed within this area of the project. All storm drain facilities will be designed in accordance with Riverside County Flood Control District (RCFC & WCD) guidelines and standards. Where needed, channel protection measures will be constructed in open areas to protect from excessive erosion. Protection measures to be considered will include, but not be limited to, energy dissipators, grouted and ungrouted rock, gabions, concrete, turf block, and turf reinforced mats.

b. Drainage Plan Development Standards

There are no floodplains or floodways within the boundaries of the project site, and the project site is not subject to dam inundation hazards. Construction of the project would result in an increase of impermeable surfaces which may increase flow velocities. The project is conditioned by the Riverside County Flood Control and Water Conservation District to address the amount of flow and maintain discharges at pre-development levels.

Prior to issuance of grading permits, the applicant shall obtain a NPDES permit from the Regional Water Quality Control Board (RWQCB) for construction activities and post-development activities. The permits will require the applicant to implement source control and structural best management

practices (BMP's) during and after construction activities. If the proposed Water Quality Management Plan for Urban Runoff (for new development within Riverside County and Incorporated Cities) is approved by the RWQCB prior to issuance of grading permits, the City shall review the grading plans to ensure appropriate source control and structural BMP's will be provided during and after construction. The City will be responsible for enforcing implementation of the BMP's.

5. Water and Sewer

a. Description

The following analyses are based on the technical water plan report entitled, *Preliminary Master Plan Water Study for City of Calimesa* and the technical sewer report entitled, *Preliminary Master Plan Sewer Study for City of Calimesa*, prepared by The Keith Companies, Inc., and dated April 22, 2004. These reports are contained in the appendices to the EIR for this project.

b. Master Water Plan

The proposed water plan is depicted in Figure III-12, *Master Water Plan*. The Master Water Plan was designed to accommodate the SUMMERWIND RANCH AT OAK VALLEY community's domestic water demand. A domestic water demand study was conducted based on the Yucaipa Valley Water District (YVWD) Water Master Plan and Water System Design Criteria for New Development (Resolution No. 32-2002). The YVWD updated their Water Master Plan in 2002. The Master Plan also identified the need for a new YVWD water filtration facility by 2006. The availability of water to SUMMERWIND RANCH AT OAK VALLEY is dependant upon completion of this facility.

The service elevation for the proposed development ranges from 2,037 to 2,377 resulting in a total differential elevation of 340 feet. To effectively service the project, the YVWD has identified three operating pressure zones. The lower portion of the site will be serviced by an onsite YVWD tank to be constructed within Phase 2 of the development with a High Water Level (HWL) of 2,340 and an ideal service elevation range from 2,037 to 2,210 feet. The second pressure zone, designated as YVWD Zone R11 with a HWL of 2,463, will service the development located within an elevation range of 2,160 to 2,333. The third pressure zone, designated as YVWD Zone R12, with a HWL of 2,600, will service the development located within an elevation range of 2,300 to 2,470 feet.

The first phase of the project may be serviced by YVWD Zone R11 (Planning Areas A-7 and A-8) and by YVWD Zone R12 (remaining first phase Planning Areas). However, the Beaumont-Cherry Valley Water District (BCVWD) is in the process of installing two high pressure water lines to be located in Cherry Valley Boulevard and in the extension of the Palmer Avenue /Desert Lawn intersection. These water lines would allow for domestic water service to Phase 1 of the project. To service the higher portions of the Specific Plan Amendment area, a Sphere of Influence Change may be processed to allow for the use of planned facilities from the BCVWD in lieu of installing booster stations or additional off-site transmission mains. If the sphere of influence change is approved, BCVWD Zone 2,520 may serve the development portion within an elevation range of 2,217 to 2,390,

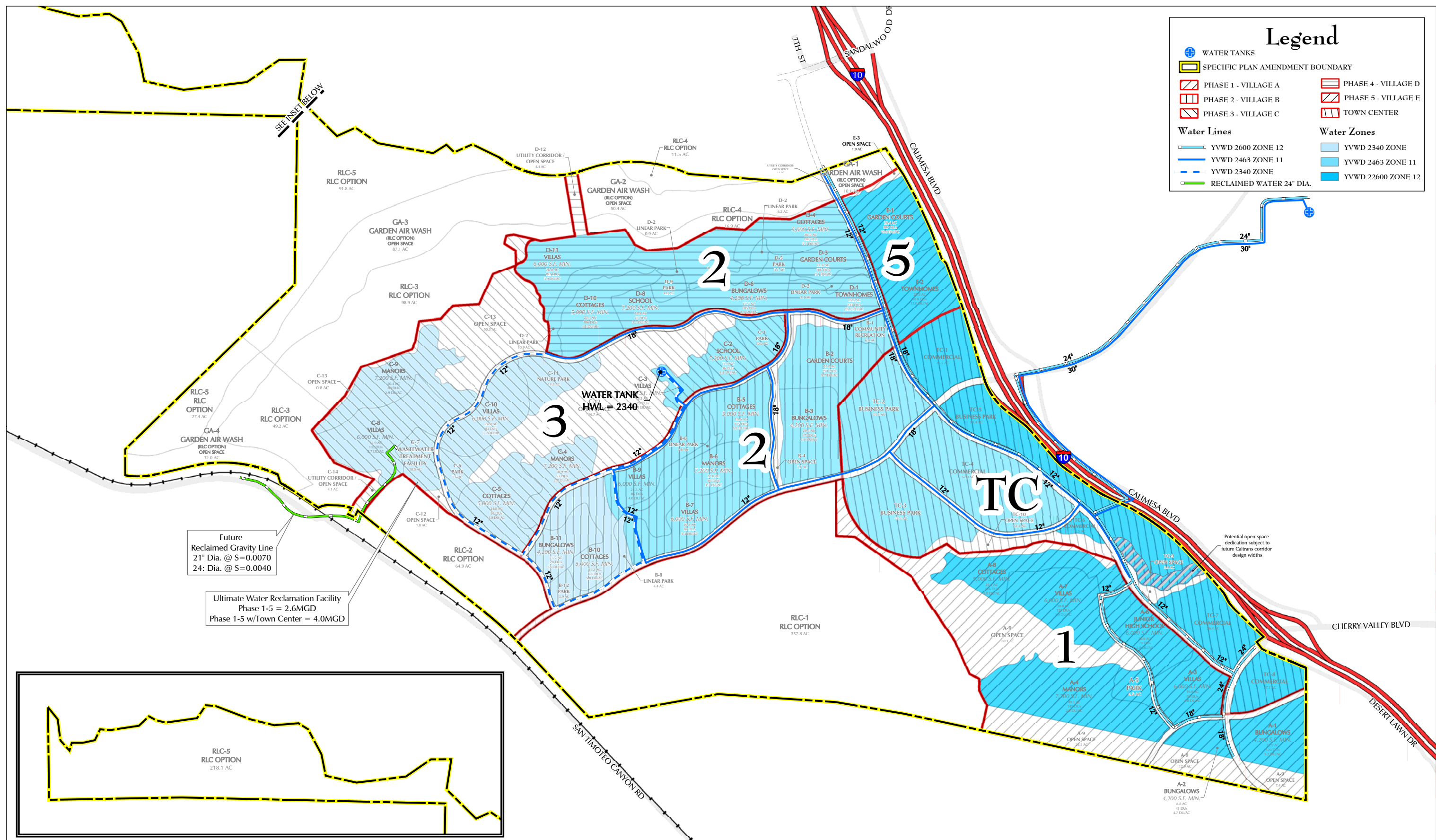

Legend

- ⊕ WATER TANKS
- SPECIFIC PLAN AMENDMENT BOUNDARY
- PHASE 1 - VILLAGE A
- PHASE 2 - VILLAGE B
- PHASE 3 - VILLAGE C
- PHASE 4 - VILLAGE D
- PHASE 5 - VILLAGE E
- TOWN CENTER

Water Lines

- YVWD 2600 ZONE 12
- YVWD 2463 ZONE 11
- YVWD 2340 ZONE
- RECLAIMED WATER 24" DIA.

Water Zones

- YVWD 2340 ZONE
- YVWD 2463 ZONE 11
- YVWD 22600 ZONE 12

Future Reclaimed Gravity Line
 21" Dia. @ S=0.0070
 24" Dia. @ S=0.0040

Ultimate Water Reclamation Facility
 Phase 1-5 = 2.6MGD
 Phase 1-5 w/Town Center = 4.0MGD

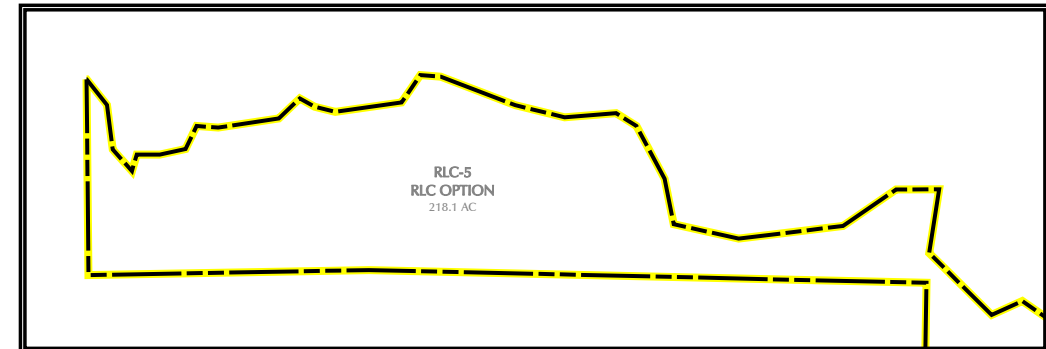

SUMMERWIND RANCH AT OAK VALLEY

Specific Plan Area No. 1,
 Amendment No. 1

The Keith Companies **T&C**
T&B PLANNING CONSULTANTS
 1774 BRADDOCK STREET, SUITE 100, OAK VALLEY, CA 92661
 www.tbplanning.com

0 250 500 1,000 Feet

FIGURE III-12
MASTER WATER PLAN

while BCVWD Zone 2,650 may service the development portion within an elevation range of 2,347 to 2,520 feet.

Approximately 66.3 acres of Phase 5, and 26.1 acres of the Town Center are not adjacent to the proposed BCVWD facilities. This area may be served by extending the YVWD facilities from Zone 12. YVWD has recently purchased a site for an additional Zone 11 storage tank on Singleton Road, which will be located approximately one mile north of I-10. The proposed tank and associated pipeline will be connected to the existing upstream water system.

The domestic water Average Daily Demand (ADD) for SUMMERWIND RANCH AT OAK VALLEY is based on the number of residential dwelling units and acreage factors for all other types of development (See appendices to the EIR). Additionally, YVWD's design criteria was used to design the water system. The Master Water facilities planned for SUMMERWIND RANCH AT OAK VALLEY will have the capacity to store approximately 9.2 million gallons of water (including a 2-hour, 1,500 gpm fire flow storage of 180,000 gallons). Onsite storage tanks will have the capacity to store 1.4 and 4.7 million gallons, respectively (including fire flow storage for each tank).

YVWD has recently updated its Urban Water Management Plan. The plan provides for a 20-year water capability which relies heavily on reclaimed water and groundwater entitlements. YVWD wishes to maximize the use of non-potable reclaimed water in all possible areas, including individual home sites where practical. Should a developer choose to provide dual piping (for potable and reclaimed water supplies), YVWD will provide meters, connection, and annual inspections without charge.

As discussed in Section IV.F., LANDSCAPE DESIGN GUIDELINES, the landscape plans for the Specific Plan Amendment will include water conservation methods, such as selecting native and drought tolerant plant materials, as well as non-native species with low water usage characteristics which are adaptable to hot, dry climates as applicable. Additionally, a computerized irrigation system will be used, which will be equipped with flow sensing capabilities; thus, the irrigation system will automatically shut down in the event of a mainline break or broken head.

c. Master Sewer Plan

Figure III-13, *Master Sewer Plan*, and the following discussion is based on the sewer study entitled *Preliminary Master Sewer Study*, included in Appendices to the EIR for this project. The sewer study is based on YVWD's Wastewater Master Plan and Sewer System Design Criteria for New Development (Resolution No. 01-1998). The sewer generation rate used in the plan was reduced as a result of water conservation efforts and actual metering data. Thus, the size of the sewer infrastructure facilities have been reduced.

The sewer generation rate for SUMMERWIND RANCH AT OAK VALLEY is based on the number of residential units and acreage factors for all other types of development. All sewer facilities were sized using YVWD's peak demand. The sewer generation for SUMMERWIND RANCH AT OAK VALLEY is illustrated in the appendices to the EIR for this project.

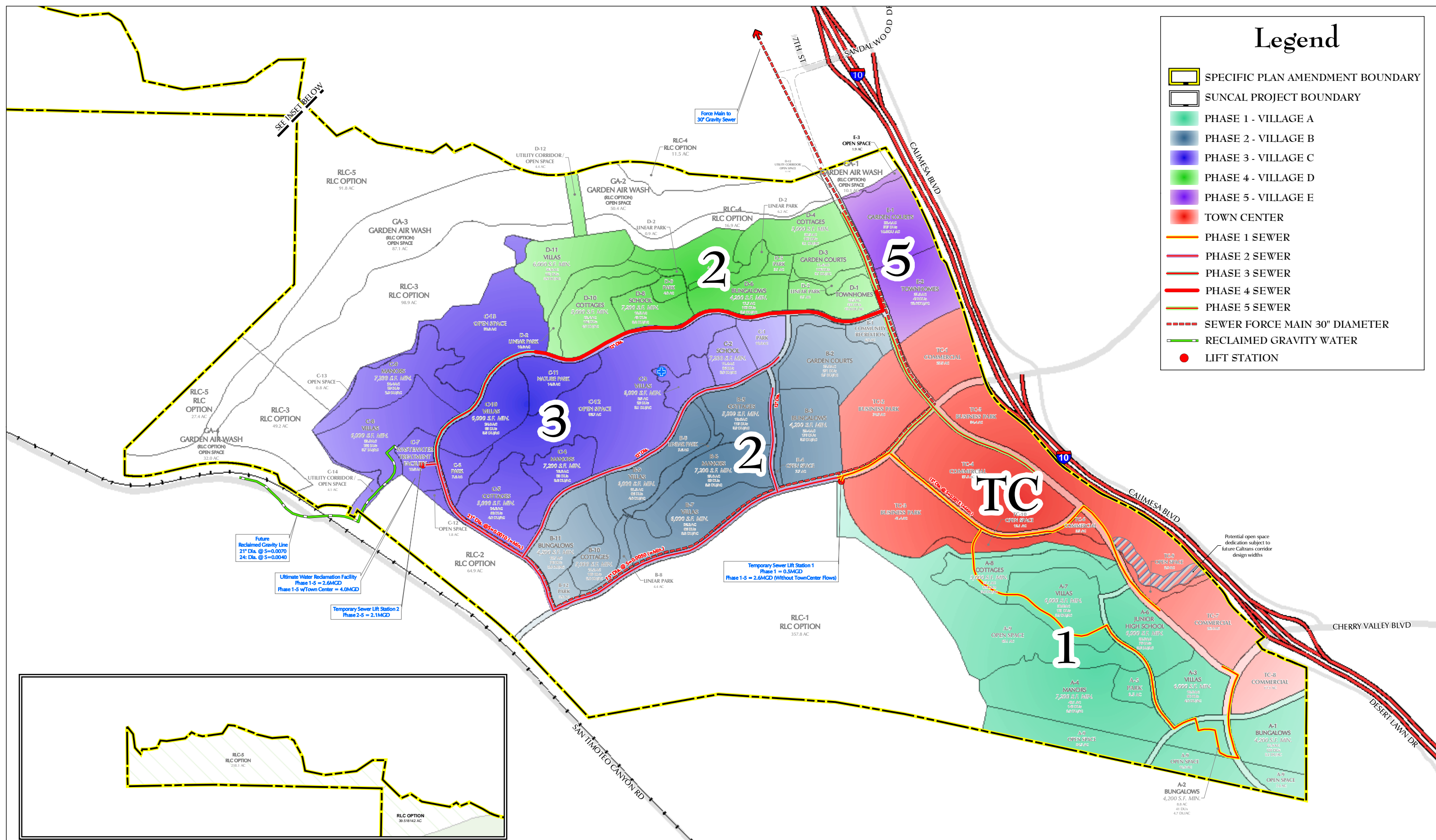

Legend

- SPECIFIC PLAN AMENDMENT BOUNDARY
- SUNCAL PROJECT BOUNDARY
- PHASE 1 - VILLAGE A
- PHASE 2 - VILLAGE B
- PHASE 3 - VILLAGE C
- PHASE 4 - VILLAGE D
- PHASE 5 - VILLAGE E
- TOWN CENTER
- PHASE 1 SEWER
- PHASE 2 SEWER
- PHASE 3 SEWER
- PHASE 4 SEWER
- PHASE 5 SEWER
- SEWER FORCE MAIN 30" DIAMETER
- RECLAIMED GRAVITY WATER
- LIFT STATION

SUMMERWIND RANCH AT OAK VALLEY

Specific Plan Area No. 1,
Amendment No. 1

The Keith Companies **TKC**

T&B PLANNING CONSULTANTS
1774 DEAN DR. #100, OAK VALLEY, CA 92661
www.tbplanning.com

0 250 500 1000 Feet

FIGURE III-13

MASTER SEWER PLAN

SUMMERWIND RANCH AT OAK VALLEY is proposed to be built in five (5) phases. The peak sewer generation rate for Phase 1 will be approximately 0.53 Million Gallons per Day (MGD). The peak sewer generation rate for Phases 2 through 5 will be approximately 2.13 MGD.

The Town Center will be developed concurrently with Phases 1 through 5. The peak sewer generation rate for the Town Center will be approximately 1.78 MGD. Thus, the total peak generation rate from SUMMERWIND RANCH AT OAK VALLEY will be 4.0 MGD.

The sewer generation from Phase 1 will be conveyed by gravity to a proposed temporary lift station. Sewer Lift Station No. 1 will be located on Singleton Road, adjacent to Planning Areas TC-3 (Business Park) and B-4 (Cottages). The force main flows from Sewer Lift Station No. 1 will be conveyed through Singleton Road and then through Roberts Road to an existing 30-inch diameter gravity sewer line.

The sewer generation from Phases 2 through 5 will be conveyed by gravity to another temporary lift station. Sewer Lift Station No. 2 will be located in Planning Area C-6, which is designated as a Water Reclamation Facility. The force main flows from Sewer Lift Station No. 2 will be conveyed to Sewer Lift Station No. 1, where the combined sewer flow will be conveyed through Singleton Road and then through Roberts Road to an existing 30-inch diameter gravity sewer line.

YVWD is planning to expand the Live Oak Canyon treatment facility. The initial expansion will provide a total capacity of 8 MGD. A subsequent expansion project will increase the total capacity to 10 MGD. This facility will serve existing and proposed development (2000 units) north of I-10 and a portion of SUMMERWIND RANCH AT OAK VALLEY. However, it will not have sufficient capacity to handle ultimate buildout of SUMMERWIND RANCH AT OAK VALLEY. Consequently, sewerage from the first phases of SUMMERWIND RANCH AT OAK VALLEY will need to be pumped northward via a combination of gravity lines and force mains.

The Yucaipa Valley Water District (YVWD) proposes to construct a 12 MGD Water Reclamation Facility on a 10-acre site within Planning Area C. The facility will be constructed in four separate units of 3 MGD each to a build out capacity of 12 MGD ultimately designed to receive wastewater from this project and other proposed projects. Discharge from this plant will connect into a proposed reclaimed water line to be built by Eastern Municipal Water District (EMWD). Construction of the line is expected to begin in 2005. The new sewage facility will require regulatory permitting and a minimum of one year for design and three years for construction. Developers will be required to pay their share of costs for development of this facility. In addition, fee credits will be available to off set direct costs. Upon construction of the permanent Water Reclamation Facility, the temporary sewer lift stations may be abandoned or converted to reclaimed water pump stations.

The gravity main from Phase 1 to Temporary Sewer Lift Station No. 1 has been preliminarily sized with diameters ranging from 8-inches at the upstream portion of the site to 15-inches (with a minimum slope of 0.15%) at the lower portion of the site. The gravity main from Temporary Sewer Lift Station No. 1 to Temporary Sewer Lift Station No. 2 has been preliminarily sized as a 15-inch diameter pipe (with a minimum slope of 0.5%), along Singleton Road, and a 21-inch diameter pipe

(with a minimum slope of 0.1%) along Street “C”. A 24-inch diameter gravity line (with a minimum slope of 0.4%) or a 21-inch gravity line (with a minimum slope of 0.7%) is proposed to convey reclaimed water from the sewer treatment plant in Planning Area C-6 to a future 24-inch diameter reclaimed gravity line within the San Timoteo Canyon Road right-of-way.

d. Development Standards for Water and Sewer

- 1.) All permanent water and sewer lines shall be placed underground.
- 2.) Water and sewerage disposal facilities shall be installed in accordance with the requirements and specifications of the State Department of Health Services and the Riverside County Health Department.
- 3.) Pursuant to SB221, YVWD and BCVWD shall provide the City with a Water Supply Assessment for the SUMMERWIND RANCH AT OAK VALLEY project.

6. Public Facilities

a. Description

The proposed land use plan for SUMMERWIND RANCH AT OAK VALLEY designates areas for various public uses such as schools, parks, a water reclamation facility, a fire station, and a City Hall (See Figure III-14, *Public Facilities*). The residential component of SUMMERWIND RANCH AT OAK VALLEY will consist of a maximum 3,841 dwelling units and will generate a population of approximately 11,561 residents at full buildout. In order to adequately meet the needs of the projected number of residents the aforementioned public facilities will be provided:

Schools

A middle school site will be provided in Village A and an elementary school site will be provided in Village C and in Village D. Each elementary school is located next to designated park space, which provides schools and parks with joint-use recreational facilities. If the school district decides that any or all three of the schools are no longer needed, each school site may be developed with single-family dwelling units. The number of dwelling units that will be allowed on each of the three school sites is indicated on Figure III-14, *Public Facilities*.

Water Reclamation Facility

The Yucaipa Valley Water District (YVWD) proposes to construct a 12 MGD Water Reclamation Facility on a 10.0 acre site within Village C. The facility will be constructed in four separate units of 3 MGD each to a build out capacity of 12 MGD ultimately designed to receive wastewater from this project and other proposed projects. The wastewater will be treated using “state of the art” technology.

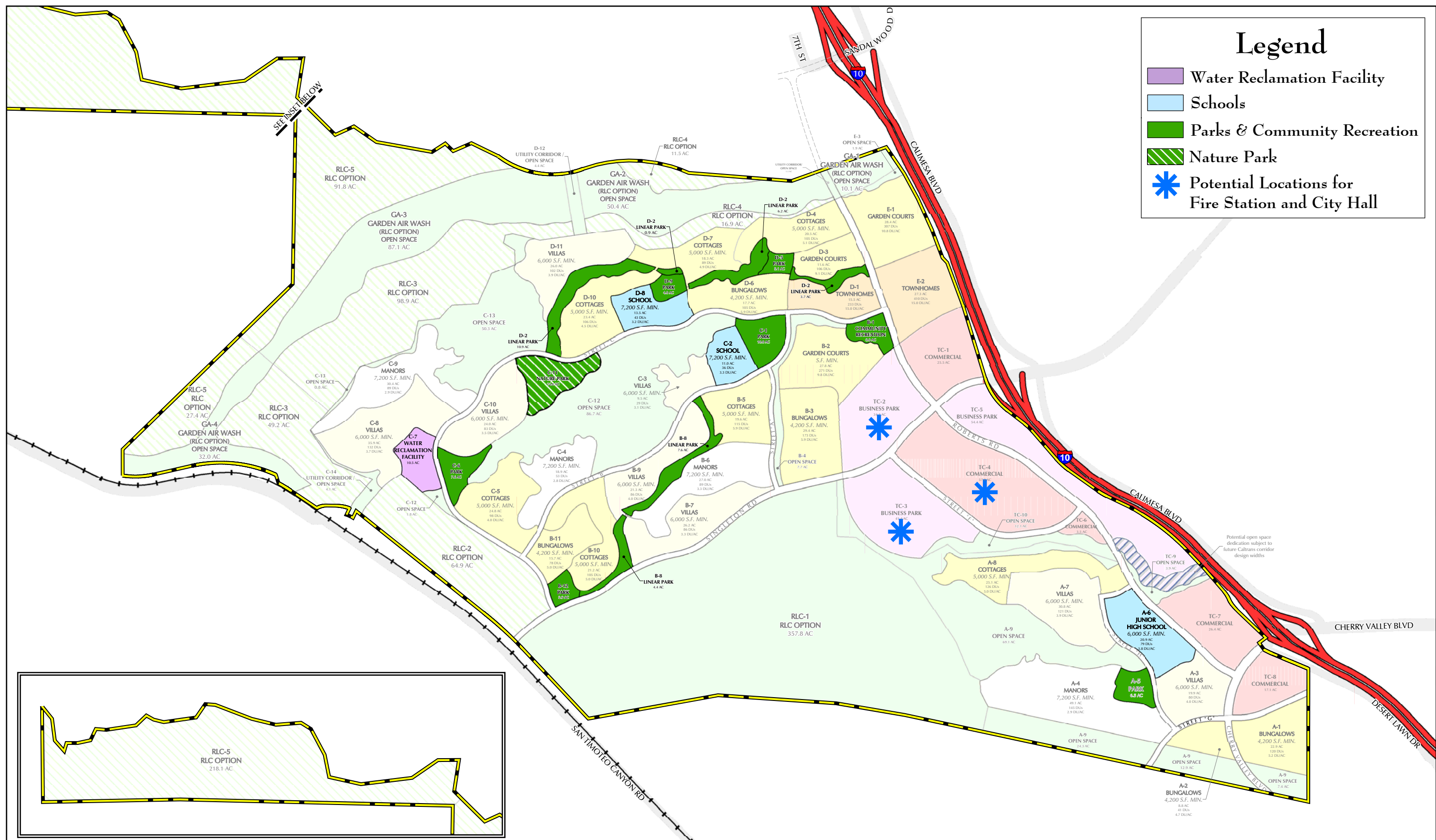

SUMMERWIND RANCH AT OAK VALLEY

Specific Plan Area No. 1,
Amendment No. 1



The Water Reclamation Facility will produce reclaimed water in compliance with California DHS Title 22 Regulations. Treated effluent will be suitable for landscape and golf course irrigation purposes and will supply the YVWD Non-Potable system serving planned commercial and industrial users and City common areas. Any excess flows will be metered and discharged to the approved EMWD reclaimed water line.

In order to treat the wastewater to an acceptable level, YVWD is proposing to use the latest membrane technology to minimize the site, to meet future regulatory requirements, to plan for the best available water source for the Non-Potable Water System (NPWS) and to potentially treat the water with reverse osmosis to reduce the total dissolved solids (TDS) concentration.

In order to reduce dependency on the potable water supply, provide an economical source of landscape irrigation water, and possibly reduce the size and cost of potable water system infrastructure, it is proposed that water from the District's proposed Water Reclamation Facility be utilized. A system of tanks and pumps will be designed to receive treated water from the on-site facility and distribute it throughout the project. Open spaces, parks, parkways and other public landscaped areas will be connected to this water source. No special plumbing will be required to use this water.

Fire Station

The City Fire Department has indicated a need for a fire station within SUMMERWIND RANCH AT OAK VALLEY. Although the developer of the Town Center has agreed to provide a location for the fire station within the Town Center, the City Fire Department has not identified an exact location.

City Hall

The City of Calimesa has indicated the need for additional building space to allow for various City departments to conduct daily business. Although the developer of the Town Center has agreed to provide the City with adequate space, the exact location for City Hall operations has not been identified. The developer will work with the City of Calimesa Planning Department to identify a suitable location prior to issuance of grading permits for the Town Center.

b. Public Facilities Standards

The project has been divided into five phases (Villages A through E). The Town Center may be developed concurrently with each of the five phases. Within each applicable phase, appropriate sites for public facilities are identified in order to keep the supply of lands for public facilities in balance with the demand created by each phase. The following procedures are proposed to insure that appropriate sites are available for the construction of public facilities.

- 1.) At the time of filing the tentative tract map for a phase or part of a phase, the specific location, character, and dimensions for each public facility site within that phase shall be refined and identified.
- 2.) The applicant for a tentative tract map shall describe the intended use and size for each public facility site, the managing entity, and the criteria that will initiate construction of the facility.
- 3.) As part of the approval process of the tentative tract map, the applicant shall secure the approval of the appropriate managing agency for each proposed public facility site. Approval shall include the site's use, size, configuration, characteristic, access, and utility service requirements.
- 4.) As part of the approval process for the final map, the applicant shall make available each parcel for public use to the appropriate agency by deed or dedication.
- 5.) If the School District decides not to acquire the schools sites, the School District shall provide the Director of Planning with a letter that states that the affected school site(s) is no longer needed and the site may be released for residential development.
- 6.) Prior to issuance of precise grading permits for the Town Center, the developer and the Director of Planning shall identify a location within the Town Center that will provide adequate space for City Hall operations.

c. Public Facilities Phasing

SUMMERWIND RANCH AT OAK VALLEY is scheduled to be developed in five phases over a 15-year period in accordance with a logical and orderly extension of roadways, public utilities, and other infrastructure. Each phase is expected to last approximately 2-3 years, with the first phase commencing in 2005. The phasing program has been proposed in response to market demands. Developers intend to develop major project roadways, as well as the master planned backbone infrastructure (including mass grading). The exact order in which the roadways and other infrastructure are constructed is dependent upon the location of each planning area and its expected development timing.

The phasing schedule is preliminary only and may undergo modification as construction commences. The order in which each planning area and the backbone infrastructure are developed may occur in sequence and in combination with other planning areas within SUMMERWIND RANCH AT OAK VALLEY. The phasing program is suggested only as a possible phasing sequence. Due to possible unforeseen changes in market conditions and absorption rates, actual development of SUMMERWIND RANCH AT OAK VALLEY may occur at an accelerated or slower rate in fewer or more phases.

7. Phasing

a. Description

The planning process progressed from a macro-scale site evaluation to a general land use plan and then to a Specific Plan Amendment. In order to prepare an effective Specific Plan Amendment, it was necessary to divide the site into villages. These villages were then divided into planning areas. The base line inventory for each planning area was assessed. Based on the resource/hazard inventory for each planning area, the conceptual land uses were assessed and refined. Residential land uses were first assigned the general density category of low, low medium, medium, or high. Based on the results of the resource/hazard inventory planning area, density values were adjusted. The intent of this refinement process was to make density assignments compatible with the resources of each planning area. The same process was used for commercial and business park uses. The projected building square footage was assigned based on the planning area resource/hazard inventory. Following the assemblage of the conceptual land use plan, a development phasing program was established. As depicted in Figure III-15, *Development Phasing Plan*, the phasing of development corresponds to the development proposed for each of the five villages and Town Center. Tables III-3 through III-8 in Section III, *Village and Neighborhoods*, of this Specific Plan Amendment summarize the amount of development that will occur in each phase.

b. Development Phasing Standards

- 1.) Construction of the development permitted hereby, including re-coordination of final subdivision maps, may be done progressively in stages in any phasing order, provided vehicular access, public facilities, and infrastructure are constructed to adequately service the dwelling units as needed for public health and safety in each stage of development and further provided that such phase of development conforms substantially with the intent and purpose of the Specific Plan Amendment.

The phasing sequence described herein is conceptual based on current market demand. Certain planning areas may be developed out of the expected sequence, or in smaller increments, provided the required infrastructure and services are available at the time of development.

8. Construction, Maintenance, and Ownership

a. Description

The public and private improvements within SUMMERWIND RANCH AT OAK VALLEY will be constructed, maintained, and owned by a combination of public and private entities as described in Table III-3, *Construction, Ownership and Maintenance Responsibilities*.

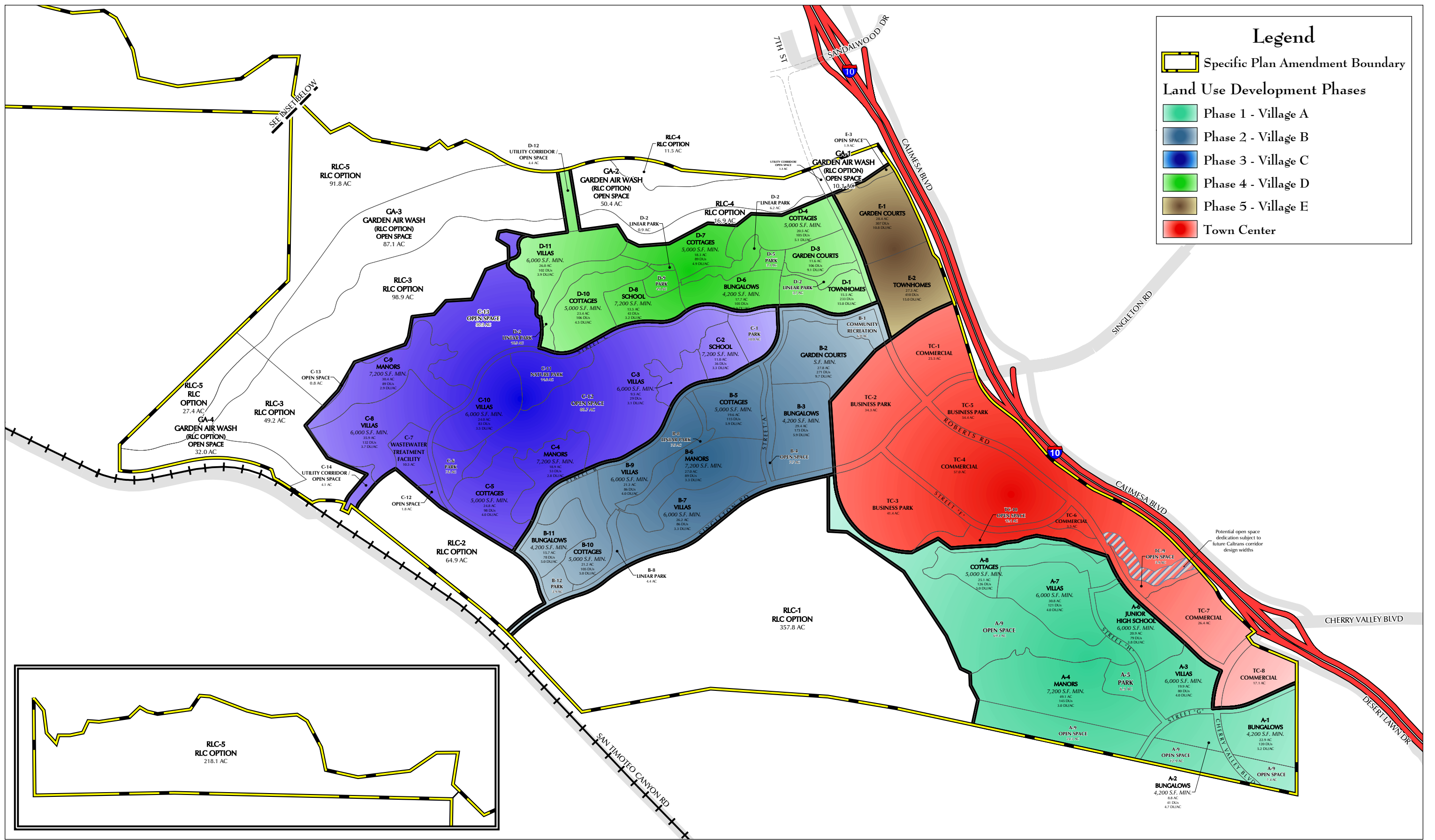

SUMMERWIND RANCH AT OAK VALLEY

FIGURE III-15

Specific Plan Area No. 1,
Amendment No. 1



DEVELOPMENT PHASING PLAN

Table III-3
Construction, Ownership, and Maintenance Responsibilities

	Construction	Ownership	Maintenance
Open Space			
Natural Open Space (RLC)	N/A	RLC	RLC
Natural Open Space	N/A	CC	MHOA
Restored Slopes	D	CC	MHOA
Fuel Modification Zone A	O	O	O
Fuel Modification Zone B	D	CC	MHOA
Equestrian Trails	D	CC/RLC/MHOA	CC
Paseo Trails	D	CC/RLC	MHOA
Hiking Trails	D	CC/RLC	CC
Improved Landscape Areas and Amenities			
Medians	D	CC	MHOA
Parkways - Major Roads	D	CC	MHOA
Parkways - Residential	D	CC	O/MHOA
Parkways - School	D	CC	MHOA
Parkways - Parks	D	CC	CC
Slope Landscaping - Major Streets	D	MHOA	MHOA
Slope Landscaping - Residential	D	SHOA/MHOA/O	MHOA
Slope Landscaping - Private Streets	D	SHOA/O	O/MHOA/SHOA
Slope Landscaping - School interior	BUSD	BUSD	BUSD
Slope Landscaping - School exterior	BUSD	BUSD	MHOA
Active Parks	D	CC	CC
Passive Parks	D	CC	CC
Linear Parks	D	CC	MHOA
Community Recreation Facility	D	MHOA	MHOA
Private Recreation Areas	B	SHOA	SHOA
Schools	BUSD	BUSD	BUSD
Interior Slopes < 30'	B	O/SHOA	O/SHOA/MHOA
Interior Slopes > 30'	D	MHOA	MHOA
Street and Other Improvements			
Public Streets and Sidewalks	D/B	CC	CC
Private Streets and Sidewalks	B	SHOA	SHOA
Major Project Monumentation	D	MHOA	MHOA
Minor Monumentation	D/B	O	MHOA
Commercial Monumentation	B	COA	COA
Trail Monumentation	D	CC/MHOA	CC/MHOA
Fencing - Equestrian (Open Space)	D	CC/RLC/MHOA	CC
Fencing - Theme (Master Developer)	D	CC	MHOA

	Construction	Ownership	Maintenance
Block Walls (exterior face only)	D	O	MHOA
Partial View (structure, glass and interior face)	D	O	O
Partial View (exterior face only)	D	O	MHOA
Full View	D	O	MHOA
Lighting - Paseo Trails	D	MHOA	MHOA
Lighting - Commercial	B	COA	COA
Street Lighting	D/B	CC	CC
Mailbox Structures	D/B	USPS/MHOA	USPS/MHOA
Storm Drain Facilities < 42" dia.	D/B	CC	CC
Storm Drain Facilities > 42" dia.	D/B	CC	RCFCD

TABLE KEY

- B** – Merchant Builder (Residential or Commercial)
- BUSD** – Beaumont Unified School District
- CC** – City of Calimesa
- COA** – Commercial Owner’s Association
- D** – Developer
- MHOA** – Master Homeowner’s Association
- O** – Property Owner
- RCFCD** – Riverside County Flood Control District
- RLC** – Riverside Land Conservancy
- SHOA** – Sub-Homeowner’s Association
- USPS** – United States Postal Service

B. Village Plans and Standards

1. Village A

As depicted in Figure III-16, *Village A* provides for development of 311.7 acres and is comprised of nine planning Areas. Planning Areas within Village A consist of residential, parks, natural open space, and a middle school. Table III-3, *Village A Planning Area Summary*, summarizes the land use, acreage, target density, maximum number of dwelling units (DU's), and minimum lot sizes for each Planning Area within Village A.

Village A is located in the southeast portion of SUMMERWIND RANCH AT OAK VALLEY adjacent to the proposed Town Center, and immediately east of dedicated open space (consisting of approximately 357.8 acres). Village A will provide low to low-medium density residential land use with convenient access to the Town Center and adjacent open space. A middle school will be provided on 20.9 acres in Village A (Planning Area A-6). If the School District decides the school site is not necessary, Planning Area A-6 may be developed with 79 Villas at a density of 3.8 du/ac. Village A will provide a total of 120.2 acres of open space and park area. Residents will enjoy convenient access to paseos and bike lanes, as well as access to equestrian and mountain bike trails located in the 113.7 acres of open space within Village A.

DEVELOPMENT STANDARDS FOR VILLAGE A

Please refer to Section V, *Summerwind Ranch Zoning Ordinance*.

PLANNING STANDARDS

1. Primary Vehicular Access Points
 - a. Planning Area A-1 Primary vehicular access shall be provided from Street "G" and Cherry Valley Boulevard.
 - b. Planning Area A-2 Primary vehicular access shall be provided from Street "G."
 - c. Planning Area A-3 Primary vehicular access shall be provided from Street "G" and Street "H."
 - d. Planning Area A-4 Primary vehicular access shall be provided from Street "H."
 - e. Planning Area A-5 Primary vehicular access shall be provided from Street "H."
 - f. Planning Area A-6 Primary vehicular access shall be provided from Street "H."
 - g. Planning Area A-7 Primary vehicular access shall be provided from Street "H."
 - h. Planning Area A-8 Primary vehicular access shall be provided from an internal roadway extension off Street "F."

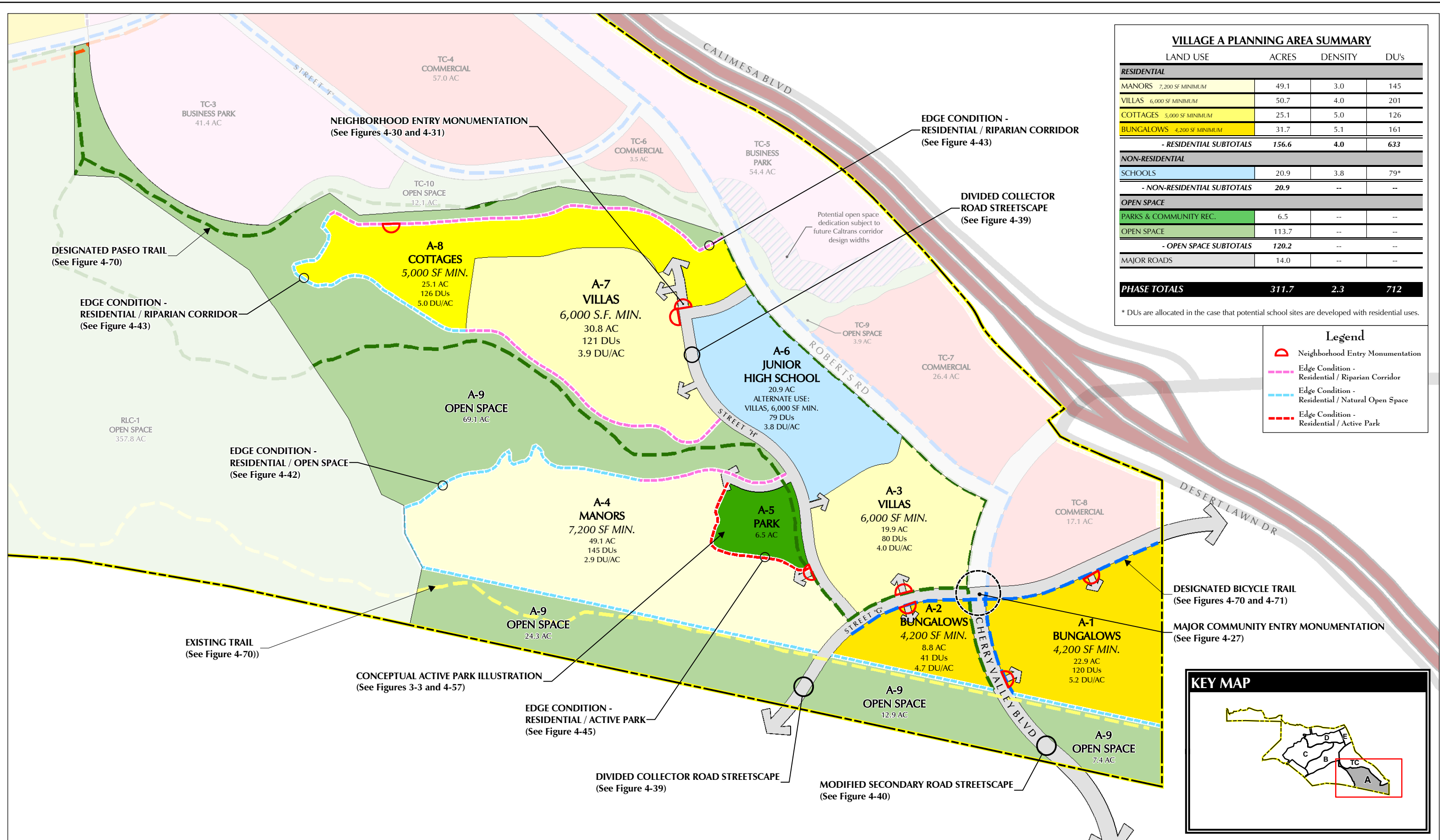

SUMMERWIND RANCH AT OAK VALLEY

Specific Plan Area No. 1,
Amendment No. 1



Table III-4
Village A Planning Area Summary

PLANNING AREA	LAND USE	MIN. LOT SIZE	ACRES	DENSITY	DU's
RESIDENTIAL					
A-1 Bungalows	Low Medium Residential (4-7 du/ac)	4,200 S.F.	22.9	5.2	120
A-2 Bungalows	Low Medium Residential (4-7 du/ac)	4,200 S.F.	8.8	4.7	41
A-3 Villas	Low Residential (2-4 du/ac)	6,000 S.F.	19.9	4.0	80
A-4 Manors	Low Residential (2-4 du/ac)	7,200 S.F.	49.1	3.0	145
A-7 Villas	Low Residential (2-4 du/ac)	6,000 S.F.	30.8	3.9	121
A-8 Cottages	Low Medium Residential (4-7 du/ac)	5,000 S.F.	25.1	5.0	126
RESIDENTIAL SUBTOTAL			156.6	4.0	633
NON-RESIDENTIAL					
A-6	Middle School	6,000 S.F.	20.9	3.8	79*
A-5	Park	--	6.5	--	--
A-9	Open Space	--	113.7	--	--
Circulation	--	--	14.0	--	--
NON-RESIDENTIAL SUBTOTAL			155.1	3.8	79*
VILLAGE A - TOTAL			311.7	2.3	712*

* Maximum number of DU's allowed if the School District does not develop the school site.

2. Residential Neighborhood Entries shall be provided at each residential primary entry as noted above (See Figure IV-29, *Neighborhood Entry Monumentation – Option 1*, and Figure IV-30, *Neighborhood Entry Monumentation – Option 2*).
3. Two major community entries shall be provided at Cherry Valley Boulevard and Street “G”, and at Roberts Road at the location where Phase 2 and Phase 5 abut the Town Center Planning Area (See Figure IV-27, *Major Community Entry Monumentation*).
4. Roadway Landscape Treatments – Please see Section IV, *Design Guidelines*, for streetscape landscape treatments for the following roadways:
 - a. Cherry Valley Boulevard
 - b. Street “G”

- c. Street "H"
5. Special Treatment/Buffers – Please see Section IV, *Design Guidelines*, for relevant figures depicting the following edge conditions:
 - a. Residential/Park- An edge condition shall be provided between Planning Areas A-4 and A-5.
 - b. Residential/Natural Open Space - An edge condition shall be provided between Residential Planning Areas A-1, A-2, A-4, A-8 and the open space contained in Planning Area A-9. The irrigated zone shall lie within the private lots and plants shall be low-fuel and fire resistive.
 - c. Residential/Riparian Corridor - An edge condition shall be provided between Planning Areas A-4, A-7, A-8, and the riparian areas contained in Planning Area A-9.
6. Please refer to Section IV, *Design Guidelines*, Figure IV-52, *Wall and Fence Plan*, Figure IV-53, *Wall and Fence Details - A*, and Figure IV-54, *Wall and Fence Details - B*, for a depiction of wall and fence details.
7. Please refer to Section III for Development Standards that apply site-wide.
8. Please refer to Section IV for specific Design Guidelines and other related design criteria.
9. As stipulated in Section IV, *Design Guidelines*, roof shingles and other roofing elements shall be made of non-combustible materials for all homes.
10. Prior to issuance of building occupancy permits, an acoustical analysis shall be conducted for those residential structures contained in Village A-1, to determine if additional mitigation measures are needed.

2. Village B

As depicted in Figure III-17, *Village B* provides for development of 250.3 acres and is comprised of twelve Planning Areas. Planning Areas within Village B consist of residential, parks, community recreation, and open space. Residential densities in Village B will range from low to medium. Village B is centrally located between designated open space to the south and open space to the north. A linear park will meander through the village and link two park sites to an open space area and the community recreation center. In addition to pedestrian and bicycle trails, residents of Village B will enjoy access to mountain bike and equestrian trails throughout the village. Table III-4, *Village B Planning Area Summary*, summarizes the land use, acreage, target density, maximum number of dwelling units (DU's) and minimum lot sizes for each Planning Area within Village B.

DEVELOPMENT STANDARDS FOR VILLAGE B

Please refer to Section V, *Summerwind Ranch Zoning Ordinance*.

PLANNING STANDARDS

1. Primary Vehicular Access Points
 - a. Planning Area B-1 Primary vehicular access shall be provided from Street "C".
 - b. Planning Area B-2 Primary vehicular access shall be provided from Street "C".
 - c. Planning Area B-3 Primary vehicular access shall be provided from Street "A" and Street "C".
 - d. Planning Area B-4 Primary vehicular access shall be provided from Street "A".
 - e. Planning Area B-5 Primary vehicular access shall be provided from Street "A".
 - f. Planning Area B-6 Primary vehicular access shall be provided from Street "A".
 - g. Planning Area B-7 Primary vehicular access shall be provided from a local roadway extending off of Singleton Road.
 - h. Planning Area B-8 Primary vehicular access shall be provided from a local roadway extending off of Singleton Road.

- i. Planning Area B-9 Primary vehicular access shall be provided from a local roadway extending off of Singleton Road.
 - j. Planning Area B-10 Primary vehicular access shall be provided from Singleton Road.
 - k. Planning Area B-11 Primary vehicular access shall be provided from Street "B" and Street "C".
 - l. Planning Area B-12 Primary vehicular access shall be provided from Street "B".
2. Residential Neighborhood Entries shall be provided at each residential primary entry as noted above (Please see Figure IV-29, *Neighborhood Entry Monumentation - Option 1*, and Figure IV-30, *Neighborhood Entry Monumentation - Option 2*).
3. Roadway Landscape Treatments - Please see Section IV, *Design Guidelines*, for streetscape landscape treatments for the following roadways:
 - a. Roberts Road
 - b. Singleton Road
 - c. Street "A"
 - d. Street "B"
 - e. Street "C"
4. Special Treatment/Buffers - Please see Section IV, *Design Guidelines*, for relevant figures depicting the following edge conditions:
 - a. Residential/Park - An edge condition shall be provided between Planning Areas B-7, B-9, B-11, and the park space in Planning Areas B-8 and B-10.
 - b. Residential/Community Recreation - An edge condition shall be provided between Planning Area B-1 and B-2.
 - c. Residential/Linear Park - An edge condition shall be provided between residential Planning Areas B-5, B-6, B-7, B-9, B-10, and B-11.
 - d. Residential/ Open Space - An edge condition shall be provided between residential Planning Areas B-1, B-2, B-3 and B-4. The irrigated zone shall lie within the private lots and plants shall be low-fuel and fire resistive.
 - e. An edge condition shall be provided between residential Planning Areas B-2, B-3, B-4, and the riparian areas contained in Planning Areas B-15 and B-16. The same edge condition shall be placed along the northern boundary of Planning Area B-1.
5. Please refer to Section IV, *Design Guidelines*, Figure IV-52, *Wall and Fence Plan*,

Figure IV-53, *Wall and Fence Details - A*, and Figure IV-54, *Wall and Fence Details - B*, for a depiction of wall and fence details.

6. Please refer to Section III for Development Standards that apply site-wide.
7. Please refer to Section IV for specific Design Guidelines and other related design criteria.
8. As stipulated in Section IV, Design Guidelines, roof shingles and other roofing elements shall be made of non-combustible materials for all homes.

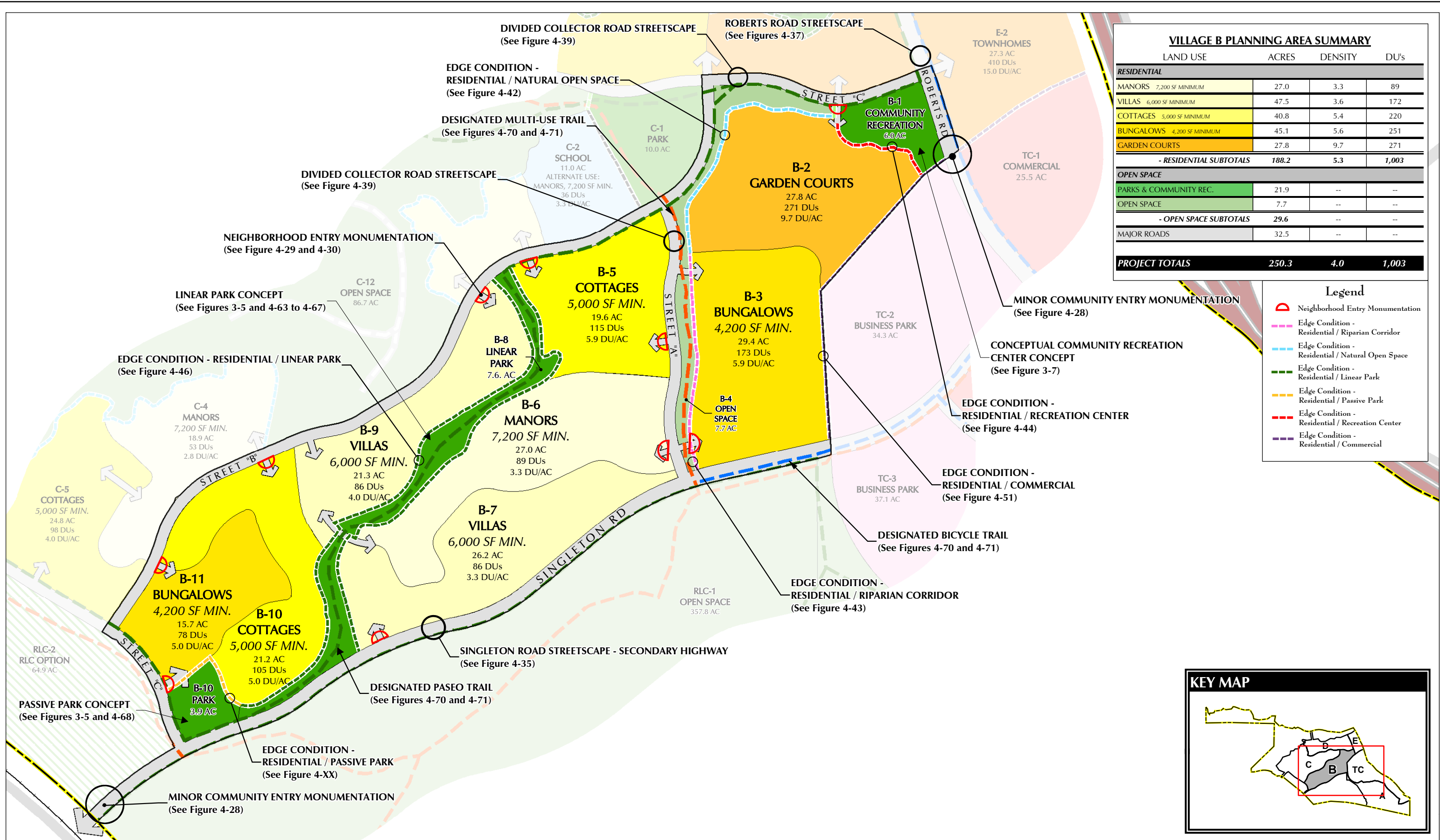

SUMMERWIND RANCH AT OAK VALLEY

Specific Plan Area No. 1,
Amendment No. 1



Table III-5
Village B Planning Area Summary

PLANNING AREA	LAND USE	MIN. LOT SIZE	ACRES	DENSITY	DU's
RESIDENTIAL					
B-2 Garden Courts	Medium Residential (7-14 du/ac)	--	27.8	9.7	271
B-3 Bungalows	Low Medium Residential (4-7 du/ac)	4,200 S.F.	29.4	5.9	173
B-5 Cottages	Low Medium Residential (4-7 du/ac)	5,000 S.F.	19.6	5.9	115
B-6 Manors	Low Residential (2-4 du/ac)	7,200 S.F.	27.0	3.3	89
B-7 Villas	Low Residential (2-4 du/ac)	6,000 S.F.	26.2	3.3	86
B-9 Villas	Low Residential (2-4 du/ac)	6,000 S.F.	21.3	4.0	86
B-10 Cottages	Low Medium Residential (4-7 du/ac)	5,000 S.F.	21.2	5.0	105
B-11 Bungalows	Low Medium Residential (4-7 du/ac)	4,200 S.F.	15.7	5.0	78
RESIDENTIAL SUBTOTAL			188.2	5.3	1003
NON-RESIDENTIAL					
B-1	Community Recreation	--	6.0	--	--
B-4	Open Space		7.7		
B-8	Park	--	12.0	--	--
B-12	Park		3.9		
Circulation	--	--	32.5	--	--
NON-RESIDENTIAL SUBTOTAL			62.1	--	--
VILLAGE B - TOTAL			250.3	5.3	1003

3. Village C

As depicted in Figure III-18, *Village C* provides for development of 356.6 acres and is comprised of fourteen Planning Areas. Planning Areas within *Village C* consists of residential, a school, parks, a wastewater treatment facility, and open space. *Village C* will consist of 143.5 acres of residential uses, 11.0 acres for a school site, 10.5 acres for a water reclamation facility, 24.8 acres of parks, and 143.7 acres of open space. Residents will enjoy access to numerous trails throughout the open space areas. Table III-5, *Village C Planning Area Summary*, summarizes the land use, acreage, target density, maximum number of dwelling units (DU's) and minimum lot sizes for each Planning Area within *Village C*.

DEVELOPMENT STANDARDS FOR VILLAGE C

Please refer to Section V, *Summerwind Ranch Zoning Ordinance*.

PLANNING STANDARDS

1. Primary Vehicular Access Points
 - a. Planning Area C-1 Primary vehicular access shall be provided from Street "B" and Street "C".
 - b. Planning Area C-2 Primary vehicular access shall be provided from Street "B".
 - c. Planning Area C-3 Primary vehicular access shall be provided from Street "B".
 - d. Planning Area C-4 Primary vehicular access shall be provided from Street "B".
 - e. Planning Area C-5 Primary vehicular access shall be provided from Street "C".
 - f. Planning Area C-6 Primary vehicular access shall be provided from Street "C".
 - g. Planning Area C-7 Primary vehicular access shall be provided from Street "C".
 - h. Planning Area C-8 Primary vehicular access shall be provided from Street "C".
 - i. Planning Area C-9 Primary vehicular access shall be provided from Street "C".
 - j. Planning Area C-10 Primary vehicular access shall be provided from Street "C".
 - k. Planning Area C-11 Primary vehicular access shall be provided from Street "C".
2. Residential Neighborhood Entries shall be provided at each residential primary entry

- as noted above (Please see Figure IV-29, *Neighborhood Entry Monumentation - Option 1*, and Figure IV-30, *Neighborhood Entry Monumentation - Option 2*).
3. Roadway Landscape Treatments – Please see Section IV, *Design Guidelines*, for streetscape landscape treatments for the following roadways:
 - a. Street “B”
 - b. Street “C”
 - c. Street “D”

 4. Special Treatment/Buffers - Please see Section IV, *Design Guidelines*, for relevant figures depicting the following edge conditions:
 - a. School/Park - An edge condition shall be provided between Planning Areas C-1 and C-2.
 - b. Residential/Riparian - An edge condition shall be provided between Planning Areas C-9 and C-11.
 - c. Residential/Wildlife Corridor - An edge condition shall be provided between residential Planning Areas C-7 and C-8, and the wildlife corridor contained in Planning Area C-12.
 - d. Residential/Open Space - An edge condition shall be provided between residential Planning Areas C-3, C-4, C-8, and the open space Planning Areas C-11 and C-12. The irrigated zone shall lie within the private lots and plants shall be low-fuel and fire resistive.

 5. Please refer to Section IV, *Design Guidelines*, Figure IV-52, *Wall and Fence Plan*, Figure IV-53, *Wall and Fence Details - A*, and Figure IV-54, *Wall and Fence Details - B*, for a depiction of wall and fence details.

 6. Please refer to Section III for Development Standards that apply site-wide.

 7. Please refer to Section IV for specific Design Guidelines and other related design criteria.

 8. As stipulated in Section IV, *Design Guidelines*, roof shingles and other roofing elements shall be made of non-combustible materials for all homes.

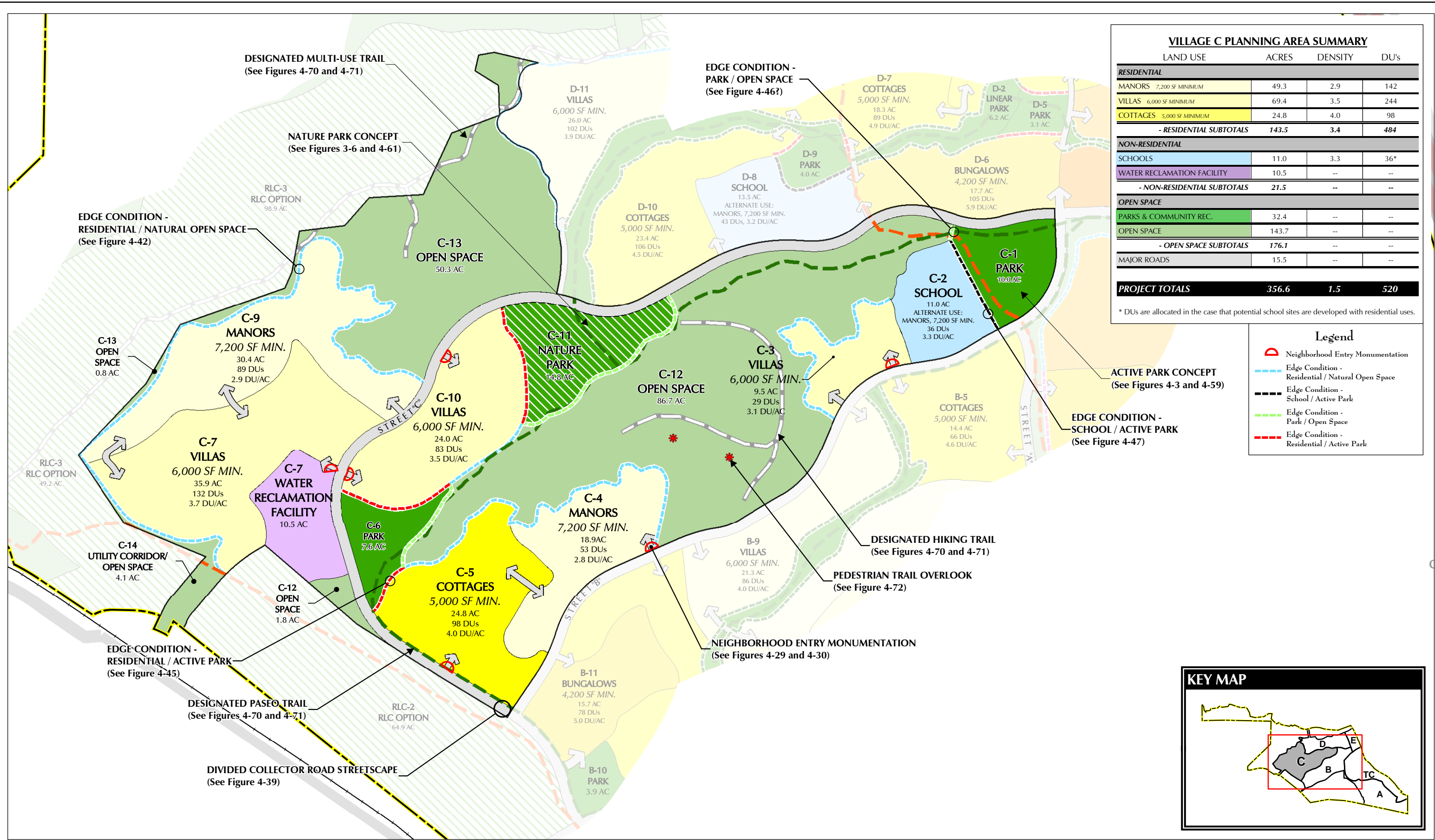

SUMMERWIND RANCH AT OAK VALLEY

Specific Plan Area No. 1,
Amendment No. 1



Table III-6
Village C Planning Area Summary

PLANNING AREA	LAND USE	MIN. LOT SIZE	ACRES	DENSITY	DU's
RESIDENTIAL					
C-3 Villas	Low Residential (2-4 du/ac)	7,200 S.F.	9.5	3.1	29
C-4 Manors	Low Residential (2-4 du/ac)	5,000 S.F.	18.9	2.8	53
C-5 Cottages	Low Residential (2-4 du/ac)	5,000 S.F.	24.8	4.0	98
C-8 Villas	Low Residential (2-4 du/ac)	6,000 S.F.	35.9	3.7	132
C-9 Manors	Low Residential (2-4 du/ac)	7,200 S.F.	30.4	2.9	89
C-10 Villas	Low Residential (2-4 du/ac)	6,000 S.F.	24.0	3.5	83
RESIDENTIAL SUBTOTAL			143.5	3.8	484
NON-RESIDENTIAL					
C-1	Park	--	10.0	--	--
C-2	School	7,200 S.F.	11.0	3.3	36*
C-6	Park	--	7.6	--	--
C-7	Wastewater Treatment Facility	--	10.5	--	--
C-11	Nature Park	--	14.8	--	--
C-12	Open Space	--	88.5	--	--
C-13	Open Space	--	51.1	--	--
C-14	Utility Corridor/Open Space		4.1		
Circulation	--	--	15.5	--	--
NON-RESIDENTIAL SUBTOTAL			213.1	3.3	36*
VILLAGE C - TOTAL			356.6	1.4	520

* Maximum number of DU's allowed if the School District does not develop the school site.

4. Village D

As depicted in Figure III-19, *Village D* provides for development of 184.3 acres and is comprised of twelve Planning Areas. Planning Areas within Village D consist of residential, a school, parks, and open space. A linear park is centrally located within the village and will provide linkage through various neighborhoods and parks in the village. Table III-6, *Village D Planning Area Summary*, summarizes the land use, acreage, target density, maximum number of dwelling units (DU's) and minimum lot sizes for each Planning Area within Village D.

DEVELOPMENT STANDARDS FOR VILLAGE D

Please refer to Section V, *Summerwind Ranch Zoning Ordinance*.

PLANNING STANDARDS

1. Primary Vehicular Access Points
 - a. Planning Area D-1 Primary vehicular access shall be provided from Street "C".
 - b. Planning Area D-2 Primary vehicular access shall be provided from a local roadway extension of Street "C".
 - c. Planning Area D-3 Primary vehicular access shall be provided from a local roadway extension of Roberts Road.
 - d. Planning Area D-4 Primary vehicular access shall be provided from a local roadway extension of Roberts Road.
 - e. Planning Area D-5 Primary vehicular access shall be provided from a local roadway extension of Street "C" .
 - f. Planning Area D-6 Primary vehicular access shall be provided from Street "C".
 - g. Planning Area D-7 Primary vehicular access shall be provided from a local roadway extension of Street "C".
 - h. Planning Area D-8 Primary vehicular access shall be provided from a local roadway extension of Street "C".
 - i. Planning Area D-9 Primary vehicular access shall be provided from local roadway extensions.
 - j. Planning Area D-10 Primary vehicular access shall be provided from Street "C".

- k. Planning Area D-11 Primary vehicular access shall be provided from a local roadway extension of Street “C”.
2. Residential Neighborhood Entries shall be provided at each residential primary entry as noted above (Please see Figure IV-29, *Neighborhood Entry Monumentation - Option 1*, and Figure IV-30, *Neighborhood Entry Monumentation - Option 2*).
3. A minor Community Entry shall be provided at Roberts Road and the northern boundary of Planning Area D-9 (Please see Figure IV-28, *Minor Community Entry Monumentation*).
4. Roadway Landscape Treatments – Please see Section IV, *Design Guidelines*, for Streetscape Landscape treatments for the following roadways:
 - a. Roberts Road
 - b. Street “C”
5. Special Treatment/Buffers - Please see Section IV, *Design Guidelines*, for relevant figures depicting the following edge conditions:
 - a. Residential/Park - An edge condition shall be provided between residential Planning Areas D-1, D-3, D-5, and the park provided in Planning Areas D-2 and D-5. The same edge condition shall be provided between the potential school site in Planning Area D-5 and the park in D-6.
 - b. Residential/Linear Park - An edge condition shall be provided between residential Planning Areas D-1, D-3, D-4, D-7, D-8, and the linear park in Planning Area D-9.
 - c. Residential/Riparian Corridor - An edge condition shall be provided between the residential Planning Areas D-4 and D-8, and the riparian areas contained in Planning Area RLC-4 to the north.
 - d. Residential/Open Space - An edge condition shall be provided between residential Planning Areas D-7 and D-8, and the open space in Planning Area C-12. The irrigated zone shall lie within the private lots and plants shall be low-fuel and fire resistive.
6. Please refer to Section IV, *Design Guidelines*, Figure IV-52, *Wall and Fence Plan*, Figure IV-53, *Wall and Fence Details - A*, and Figure IV-54, *Wall and Fence Details - B*, for a depiction of wall and fence details.
7. Please refer to Section III for Development Standards that apply site-wide.
8. Please refer to Section IV for specific Design Guidelines and other related design criteria.

9. As stipulated in Section IV, Design Guidelines, roof shingles and other roofing elements shall be made of non-combustible materials for all homes.

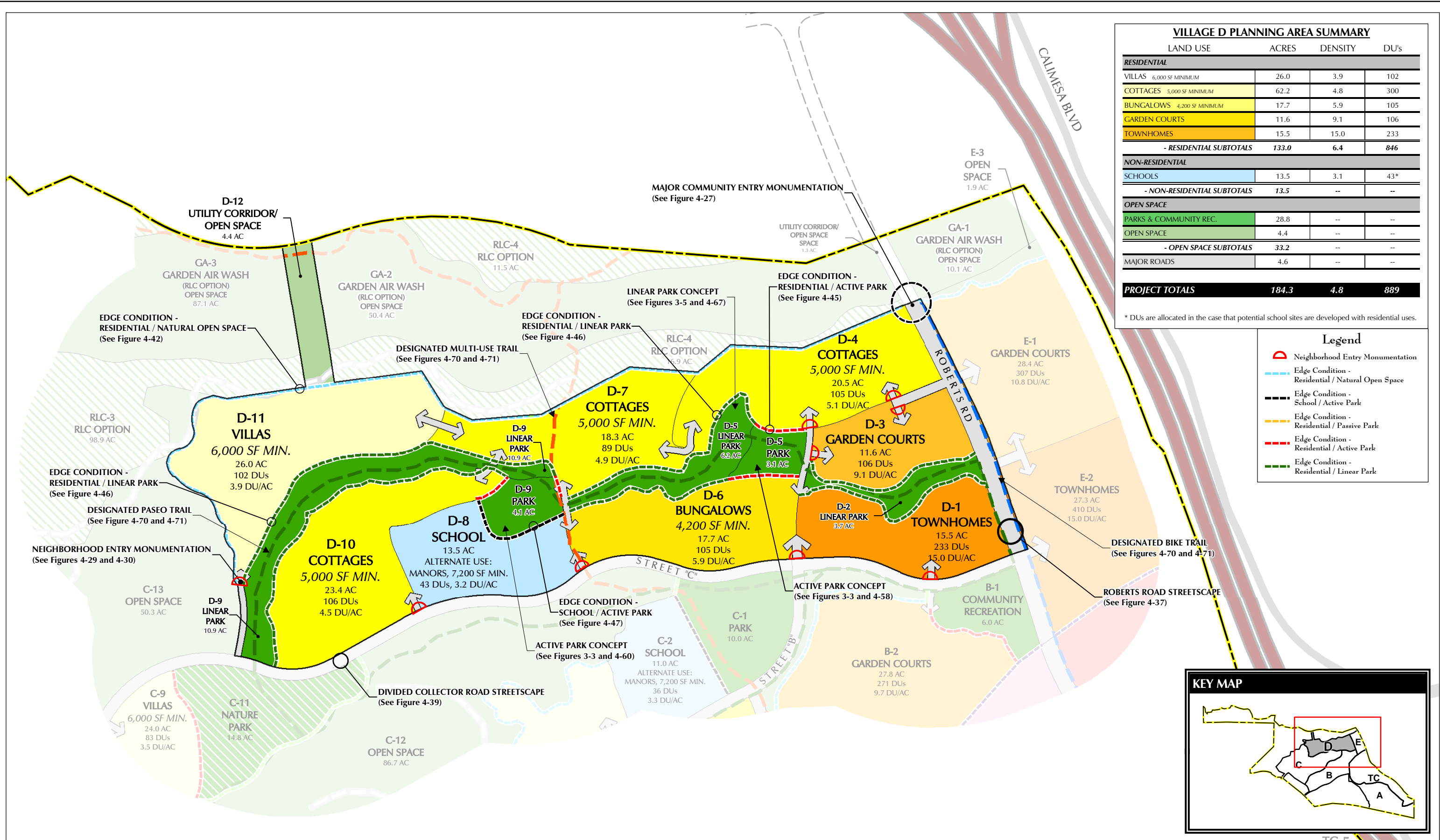

VILLAGE D PLANNING AREA SUMMARY			
LAND USE	ACRES	DENSITY	DU's
RESIDENTIAL			
VILLAS 6,000 SF MINIMUM	26.0	3.9	102
COTTAGES 5,000 SF MINIMUM	62.2	4.8	300
BUNGALOWS 4,200 SF MINIMUM	17.7	5.9	105
GARDEN COURTS	11.6	9.1	106
TOWNHOMES	15.5	15.0	233
- RESIDENTIAL SUBTOTALS	133.0	6.4	846
NON-RESIDENTIAL			
SCHOOLS	13.5	3.1	43*
- NON-RESIDENTIAL SUBTOTALS	13.5	--	--
OPEN SPACE			
PARKS & COMMUNITY REC.	28.8	--	--
OPEN SPACE	4.4	--	--
- OPEN SPACE SUBTOTALS	33.2	--	--
MAJOR ROADS	4.6	--	--
PROJECT TOTALS	184.3	4.8	889

* DUs are allocated in the case that potential school sites are developed with residential uses.

Legend	
	Neighborhood Entry Monumentation
	Edge Condition - Residential / Natural Open Space
	Edge Condition - School / Active Park
	Edge Condition - Residential / Passive Park
	Edge Condition - Residential / Active Park
	Edge Condition - Residential / Linear Park

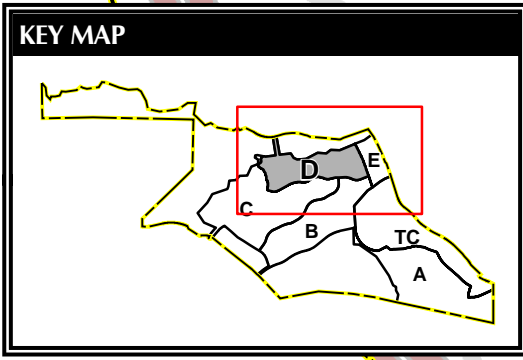

SUMMERWIND RANCH AT OAK VALLEY

Specific Plan Area No. 1,
Amendment No. 1



Table III-7
Village D Planning Area Summary

PLANNING AREA	LAND USE	MIN. LOT SIZE	ACRES	DENSITY	DU's
RESIDENTIAL					
D-1 Townhomes	High Residential (14-20 du/ac)	--	15.5	15.0	233
D-3 Garden Courts	Medium Residential (7-14 du/ac)	--	11.6	9.1	106
D-4 Cottages	Low Medium Residential (4-7 du/ac)	5,000 S.F.	20.5	5.1	105
D-6 Bungalows	Low Medium Residential (4-7 du/ac)	4,200	17.7	5.9	105
D-7 Cottages	Low Medium Residential (4-7 du/ac)	5,000 S.F.	18.3	4.9	89
D-10 Cottages	Low Medium Residential (4-7 du/ac)	5,000 S.F.	23.4	4.5	106
D-11 Villas	Low Residential (2-4 du/ac)	6,000 S.F.	26.0	3.9	102
RESIDENTIAL SUBTOTAL			133.0	6.4	846
NON-RESIDENTIAL					
D-2	Park	--	21.7	--	--
D-5	Park	--	3.1	--	--
D-8	School	7,200 S.F.	13.5	3.2	43*
D-9	Park	--	4.0	--	--
D-12	Open Space		4.4		
Circulation	--	--	4.6	--	--
NON-RESIDENTIAL SUBTOTAL			51.3	.84	*43
VILLAGE D – TOTAL			184.3	4.8	889

* Maximum number of DU's allowed if the School District does not develop the school site.

5. Village E

As depicted in Figure III-20, *Village E* provides for development of 57.6 acres and is comprised of three Planning Areas. Planning Areas within Village E consists of residential uses and 1.9 acres of open space. Table III-7, *Village E Planning Area Summary*, summarizes the land use, acreage, target density, maximum number of dwelling units (DU's) and minimum lot sizes for each Planning Area within Village E.

DEVELOPMENT STANDARDS FOR VILLAGE E

Please refer to Section V, *Summerwind Ranch Zoning Ordinance*.

PLANNING STANDARDS

1. Primary Vehicular Access Points
 - a. Planning Area E-1. Primary vehicular access shall be provided from Roberts Road.
 - b. Planning Area E-2. Primary vehicular access shall be provided from Roberts Road.
2. Residential Neighborhood Entries shall be provided at each residential primary entry as noted above (Please see Figure IV-29, *Neighborhood Entry Monumentation – Option 1*, and Figure IV-30, *Neighborhood Entry Monumentation – Option 2*).
3. Special Treatment/Buffers – Please see Section IV, *Design Guidelines*, for relevant figures depicting the following edge conditions.
 - a. Residential/I-10 Corridor - An edge condition shall be provided between Planning Areas E-1 and E-2, and the I-10 corridor.
 - b. Residential/Commercial - An edge condition shall be provided between Planning Areas E-2 and the commercial area in Planning Area E-2 and the commercial area in Planning Area TC-1 to the south.
 - c. Residential/Open Space - An edge condition shall be provided between Planning Areas E-1 and E-3. The irrigated zone shall lie within the private lots and plants shall be low-fuel and fire resistive.
4. Please refer to Section IV, *Design Guidelines*, Figure IV-52, *Wall and Fence Plan*, Figure IV-53, *Wall and Fence Details - A*, and Figure IV-54, *Wall and Fence Details - B*, for a depiction of wall and fence details.
5. Please refer to Section III for Development and Standards that apply site-wide.
6. Please refer to Section IV for specific Design Guidelines and other related design criteria.

7. As stipulated in Section IV, Design Guidelines, roof shingles and other roofing elements shall be made of non-combustible materials for all homes.
8. Prior to issuance of building occupancy permits, an acoustical analysis shall be conducted for those residential structures contained in Villages E-1 and E-2, to determine if additional mitigation measures are needed.

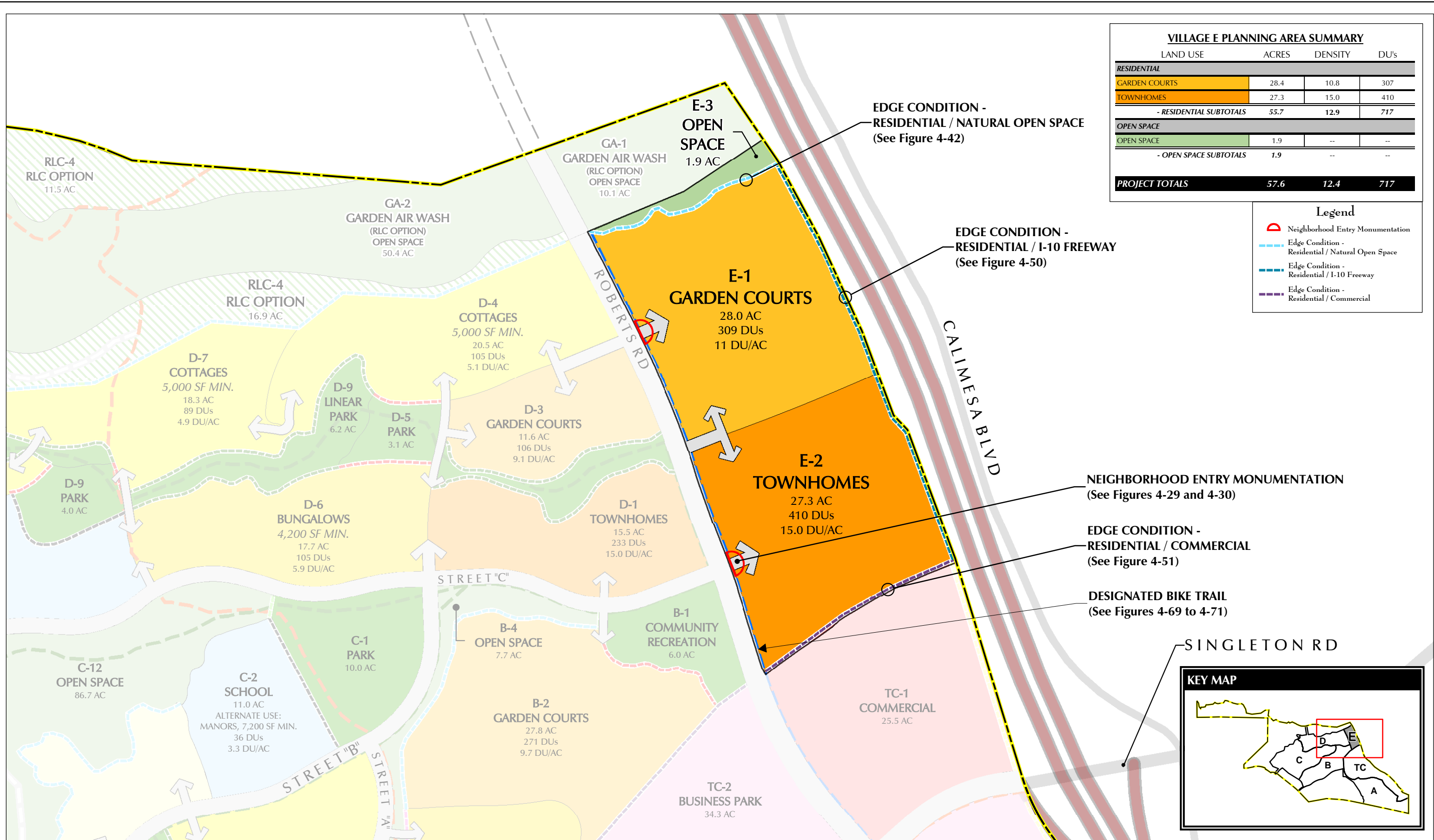

SUMMERWIND RANCH AT OAK VALLEY

Specific Plan Area No. 1,
Amendment No. 1



Table III-8
Village E Planning Area Summary

PLANNING AREA	LAND USE	MIN. LOT SIZE	ACRES	DENSITY	DU's
RESIDENTIAL					
E-1 Garden Courts	Medium Residential (7-14 du/ac)	--	28.4	10.8	307
E-2 Townhomes	High Residential (14-20 du/ac)	--	27.3	15.0	410
RESIDENTIAL SUBTOTAL			55.7	12.9	717
NON-RESIDENTIAL					
E-3	Open Space	--	1.9	--	--
NON-RESIDENTIAL SUBTOTAL			1.9	--	--
VILLAGE E - TOTAL			57.6	12.4	717

6. Town Center

As depicted in Figure III-21, the Town Center provides for development of 312.8 acres and is comprised of ten Planning Areas. Business park and commercial uses will be conveniently located near the I-10 Freeway. An open space corridor will be provided through the Town Center and will provide a trail connection on both sides of the freeway while providing a buffer between the Town Center and residential uses to the south. The Town Center will provide a minimum of 150 residential dwelling units provided at a rate that is affordable to individuals or families as determined by the most recent projections from the United States Census Bureau. Table III-8, *Town Center Summary*, summarizes the land uses and associated acreages that will be provided in the Town Center.

DEVELOPMENT STANDARDS FOR TOWN CENTER

Please refer to Section V, *Summerwind Ranch Zoning Ordinance*.

PLANNING STANDARDS

1. Primary Vehicular Access Points
 - a. Planning Area TC-1 Primary vehicular access shall be provided from Singleton Road and Roberts Road.
 - b. Planning Area TC-2 Primary vehicular access shall be provided from Singleton Road and Roberts Road.
 - c. Planning Area TC-3 Primary vehicular access shall be provided from Singleton Road and Street “F”.
 - d. Planning Area TC-4 Primary vehicular access shall be provided from Roberts Road, Singleton Road, and Street “F”.
 - e. Planning Area TC-5 Primary vehicular access shall be provided from Singleton Road and Roberts Road.
 - f. Planning Area TC-6 Primary vehicular access shall be provided from Roberts Road and Street “F”.
 - g. Planning Area TC-7 Primary vehicular access shall be provided from Roberts Road and Cherry Valley Boulevard.
 - h. Planning Area TC-8 Primary vehicular access shall be provided from Cherry Valley Boulevard and Street “G”.

2. A special feature monumentation shall be provided at the Cherry Valley Boulevard/Roberts Road, and Singleton Road/Roberts Road intersection (Please see Section IV, *Design Guidelines*)
3. A major community entry shall be provided at the Cherry Boulevard/ Street “G” intersection (Please see Figure IV-29, *Major Community Entry Monumentation*).
4. Commercial documentation shall be provided at the commercial entries in Planning Areas TC-14, TC-4, TC-7, and TC-8 (Please see Figure IV-24, *Commercial Monumentation- Option 1*, and Figure IV-25, *Commercial Monumentation- Option 2*).
5. Roadway Landscape Treatments –Please see Section IV, *Design Guidelines*, for streetscape landscape treatments for the following roadways:
 - a. Cherry Valley Boulevard
 - b. Roberts Road
 - c. Singleton Road
 - d. Street “F”
6. Special Treatment/ Buffers- Please see Section IV, *Design Guidelines*, for relevant figures depicting the following edge conditions:
 - a. Commercial/Business Park/I-10 Corridor-An edge condition shall be provided between the Business Park and Commercial Uses in Planning Areas TC-1, TC-5, TC-7, TC-8, and the I-10 Freeway.
 - b. Commercial/Business Park/Open Space- An edge condition shall be provided between Planning Areas TC-3, TC-5, TC-6, TC-7, and the open space in Planning Areas TC-9, TC-10, and RLC-1.
 - c. Business Park/Commercial/Residential- An edge condition shall be provided between Planning Areas TC-1 and TC-2 and the residential Planning Areas B-2, B-4, and E-2 to the north.
7. Please refer to Section IV, *Design Guidelines*, Figure IV-52, *Wall and Fence Plan*, Figure IV-53, *Wall and Fence Details - A*, and Figure IV-54, *Wall and Fence Details - B*, for a depiction of wall and fence details.
8. Please refer to Sections III for Development Standards that apply site-wide.
9. Please refer to Section IV for specific Design Guidelines and other related design criteria.

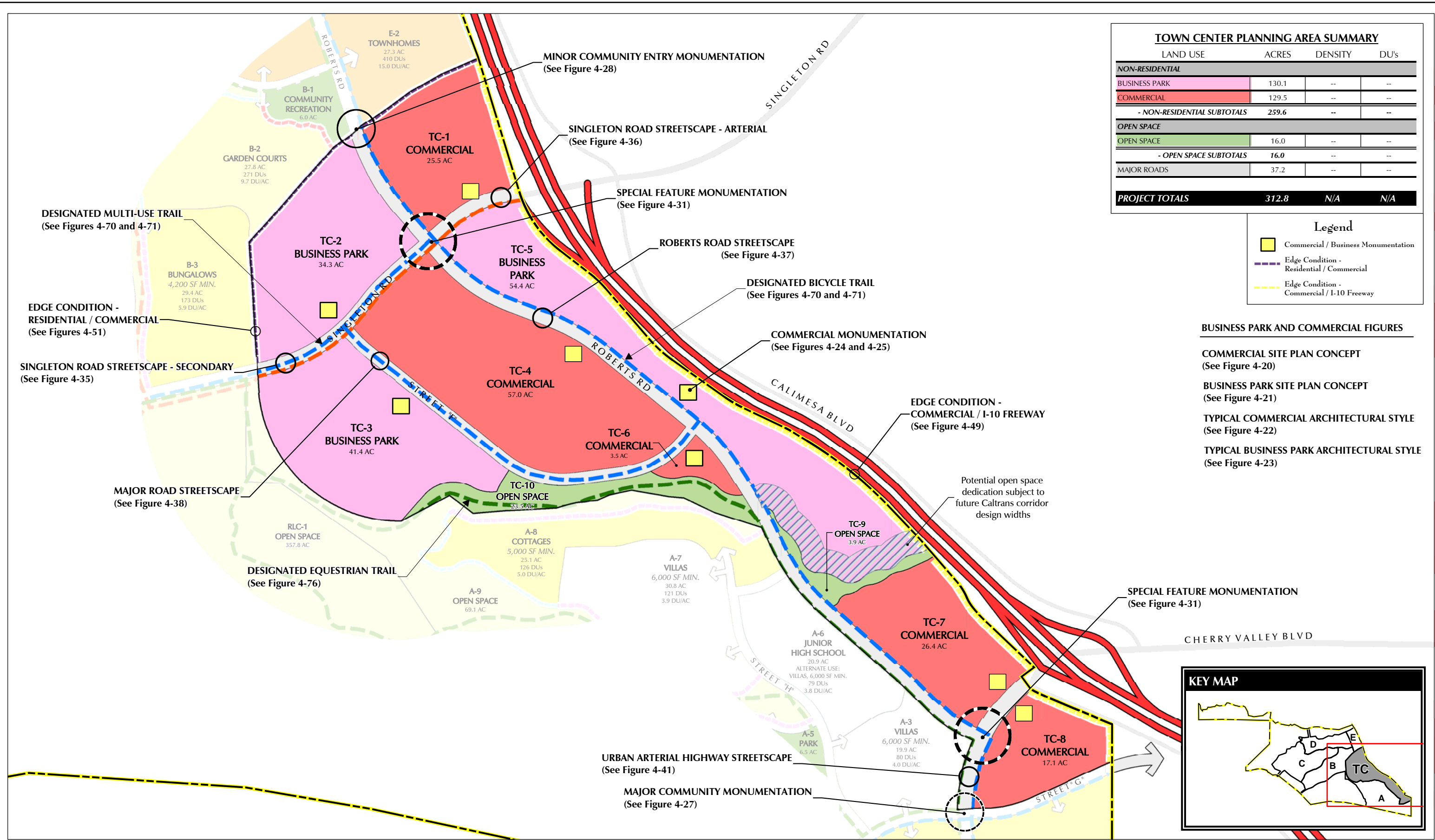

SUMMERWIND RANCH AT OAK VALLEY

Specific Plan Area No. 1,
Amendment No. 1



Table III-9
Town Center Summary

PLANNING AREA	LAND USE	ACRES
TC-1	Commercial	25.5
TC-2	Business Park	34.3
TC-3	Business Park	41.4
TC-4	Commercial	57.0
TC-5	Business Park	54.4
TC-6	Commercial	3.5
TC-7	Commercial	26.4
TC-8	Commercial	17.1
TC-9	Open Space	3.9
TC-10	Open Space	12.1
Circulation	--	37.2
TOTAL	--	312.8

IV. DESIGN GUIDELINES

A. Purpose and Intent

These Design Guidelines are intended to establish the pattern and intensity of development for SUMMERWIND RANCH AT OAK VALLEY in order to reach the goal for a high-quality project and to provide an aesthetically cohesive environment. These guidelines will establish the quality of the architectural and landscape development for the community but they are not intended to prevent the developer(s) from utilizing alternative designs and/or concepts that are compatible with the overall project theme. SUMMERWIND RANCH AT OAK VALLEY is to have a “Western Prairie” theme running through its elements of design. This will be achieved by using elements such as native preservation, organic components, naturalistic trails, rural and vernacular landscape, pastoral vistas, pioneer heritage, and formal simplicity among other characteristics. Other prominent components to this design will be elements such as wrought iron, wildflowers, windrows, orchards, grasses, and stone walls.

More specifically, the objectives of the design guidelines are:

- ❑ To provide clear direction to decision makers on the intent of the Specific Plan Amendment, thus reducing the possibility of confusing interpretation and subjective decisions regarding the Specific Plan Amendment’s implementation.
- ❑ To provide guidance in formulating precise development plans. To outline community design objectives and community structure framework, and to address residential product design, landscape structure and design, and community elements such as trails, walls, fencing, and parks.
- ❑ To establish a consistent design expression among site planning, architectural and landscape architectural components while allowing reasonable flexibility in design.
- ❑ To create livable neighborhoods rather than subdivisions.
- ❑ Reinforce the community’s intended theme with historic architectural styles, appropriate landscaping, and village layout.
- ❑ Establish a strong sense of community with shared community spaces, a trail system, monumentation and quality architectural designs.
- ❑ Provide project continuity and compatibility with surrounding uses through site planning, building design, street design, landscaping and other design elements that will endure for the life of the community.
- ❑ Provide for a range of housing products that are responsive to local needs and market demands.

These Design Guidelines are intended to be flexible and are, therefore, illustrative in nature. As a flexible document, the Guidelines can, over time, accommodate changes in lifestyles, buyers' tastes, economic conditions, community desires and the marketplace.

The landscape architectural guidelines complement the architectural guidelines. Together they combine to form a distinctive community offering a high quality environment and sense of identity. In addition, Plant Material Guidelines provide guidance as to the proper plant materials for certain community settings such as entries and streetscapes.

B. Introduction

These guidelines are comprised of elements which define the design concept, physical character, and theme of SUMMERWIND RANCH AT OAK VALLEY. The principle components of this section are: Architectural Design Guidelines, Community Elements, and Landscape Guidelines.

The *Architectural Design Guidelines* are intended to provide a basis for decisions on how the structural environment is to be built. A high quality living environment is defined by the guidelines for site planning, architectural theme and details, building mass and scale, materials and color and articulations. By defining these elements, assurance is provided that the homes and other buildings constructed in SUMMERWIND RANCH AT OAK VALLEY will have a distinctive identity and be high-quality.

The *Community Elements* are comprised of the key project components such as project theme, monumentation, streetscapes, edge conditions between land uses, community walls and fences, parks, and trails.

The *Landscape Design Guidelines* present general requirements relating to the plant palette and ensuring that they are compatible with the community design theme.

SUMMERWIND RANCH AT OAK VALLEY is approximately 2590.7 acres and incorporates residential, commercial, business park, recreational parks and open space uses. The community has been planned to maximize the benefits of the distinguishing qualities of its location and topography. SUMMERWIND RANCH AT OAK VALLEY has been influenced by and is sensitive to the environment in which the community is planned. The overall community structure, or components which provide the framework to achieve the project's design objectives, include a circulation system that provides adequate vehicular and pedestrian access and connects the community to the existing roadway and trail network, a park and open space design that provides recreational amenities, neighborhood architectural design that reflects historic character, and a landscape framework that establishes unique neighborhood character.

C. Architectural Design Guidelines

SUMMERWIND RANCH AT OAK VALLEY is designed to include residential neighborhoods as a substantial portion of the overall community. Thus, the architectural design guidelines focus primarily on residential land uses.

1. Residential Criteria

The goal of SUMMERWIND RANCH AT OAK VALLEY is to provide residential homes which exhibit outstanding design, provide a variety of housing opportunities, and are sensitive to their historical context. It is envisioned that the architecture for these neighborhoods will be created through thoughtful analysis and consideration of the development's theme, as well as the constraints, opportunities and characteristics of each neighborhood. Architectural and residential construction standards will conform to and address site conditions/characteristics such as fire hazards and drought tolerant landscaping. Each neighborhood shall provide diversity in design through considerate attention to architectural character and floor plan livability. Architectural diversity should be created by manipulating building materials, colors, and textures, in conjunction with architectural features (e.g. roofs, windows, doors, fascias, trim), rather than by designing buildings that vary greatly in architectural styles. All architecture shall enhance and enrich the overall community theme.

2. Architectural Theme

Architecture within SUMMERWIND RANCH AT OAK VALLEY shall reflect a variety of themes and styles, each with a distinct sense of history, by utilizing materials, forms, and color. Each of these styles is somewhat rustic and rural in nature and therefore is cohesive with the overall theme planned for SUMMERWIND RANCH AT OAK VALLEY.

SUMMERWIND RANCH AT OAK VALLEY shall encourage the development of architectural designs based on appropriate interpretations of historical styles which address the economics of today's market as well as meet the codes and standards within the building industry. The styles which have been identified for the residential neighborhoods are: Craftsman/Bungalow, American Farmhouse, California Ranch, Prairie, Monterey, and French Country. Different elevations shall be required within each architectural style chosen. Elevation variations can be accomplished through the creative use of material and color palettes and different floor plans. Primary building colors shall provide a visually noticeable variation when the homes are grouped together along each neighborhood street. A variety of styles will foster creativity and add interest to the residential neighborhoods. This variety will also serve to give the community a more "established" presence rather than a uniform style that was obviously constructed all at once. This diverse and visually interesting combination will lend the community character, ambiance, and an aesthetic with depth and richness. The illustrations contained in the Design Guidelines are conceptual and do not depict final designs, nor should they limit the range of expression among individual builders and their professional design teams. Designs that can create a distinct neighborhood identity while expressing a thoughtful integration of building structures in a planned community are encouraged. To that end, a variety of architectural styles have been selected to provide a historical character to the community,

rather than contemporary designs which are soon dated or the overly uniform architecture of some newer planned communities.

Architectural design for SUMMERWIND RANCH AT OAK VALLEY should ensure that housing facades include features such as porches, entry doors, windows, outdoor living areas or courtyards that relate to the adjacent street(s) to create a welcoming appearance and promote individuality. The architectural character of each neighborhood should be perceived from the street and interest should be created through consistency in the use of architectural elements such as windows, doors, balconies and roofs.

The design of multi-family residential development should avoid long, unbroken building faces and make offsets an integral part of the design. The site design should also buffer multi-family uses from adjacent uses such as utilities, single-family residential neighborhoods, and collector roadways through the sensitive placement of garages, buildings, landscaping, berms, or roads at the property line to avoid negative impacts. Additionally, site design should orient individual buildings of multi-family residential neighborhoods toward open space areas, recreational features and enhanced edges.

The street layout for the project shall avoid long, straight streets wherever possible. The use of curvilinear streets on long stretches and the formation of cul-de-sacs, especially when located adjacent to greenbelt areas, will be encouraged. When extensive use of cul-de-sacs occur it is important to establish a hierarchy of streets so that the neighborhood may be easily navigated.

The following descriptions and referenced graphics provide an overview of the general architectural styles desired for SUMMERWIND RANCH AT OAK VALLEY. Again, it should be emphasized that individual character and interpretation are encouraged and it is not the intent that all of the following represented design components be incorporated into the design proposals. Rather, the design components shall be used as a “palette” of character defining design elements for residential housing types that shall be reflected.

3. Site Planning Characteristics

Clustered Development Concept

The SUMMERWIND RANCH AT OAK VALLEY land use plan demonstrates the concept of clustering residential neighborhoods. Clustering is a planning technique that focuses on the preservation of natural open space, clustering residential neighborhoods in harmony with the natural features that surround it. Clustering results in a diverse community that enhances opportunities for preservation, recreation, scenic corridors, and housing variety. This concept is shown in Figure 4-1, *Clustered Development Concept*. The design at SUMMERWIND RANCH AT OAK VALLEY has been arranged so that significant ridgelines, drainages, and wildlife corridors fall into the natural open space areas.

OPPORTUNITIES & CONSTRAINTS ANALYSIS

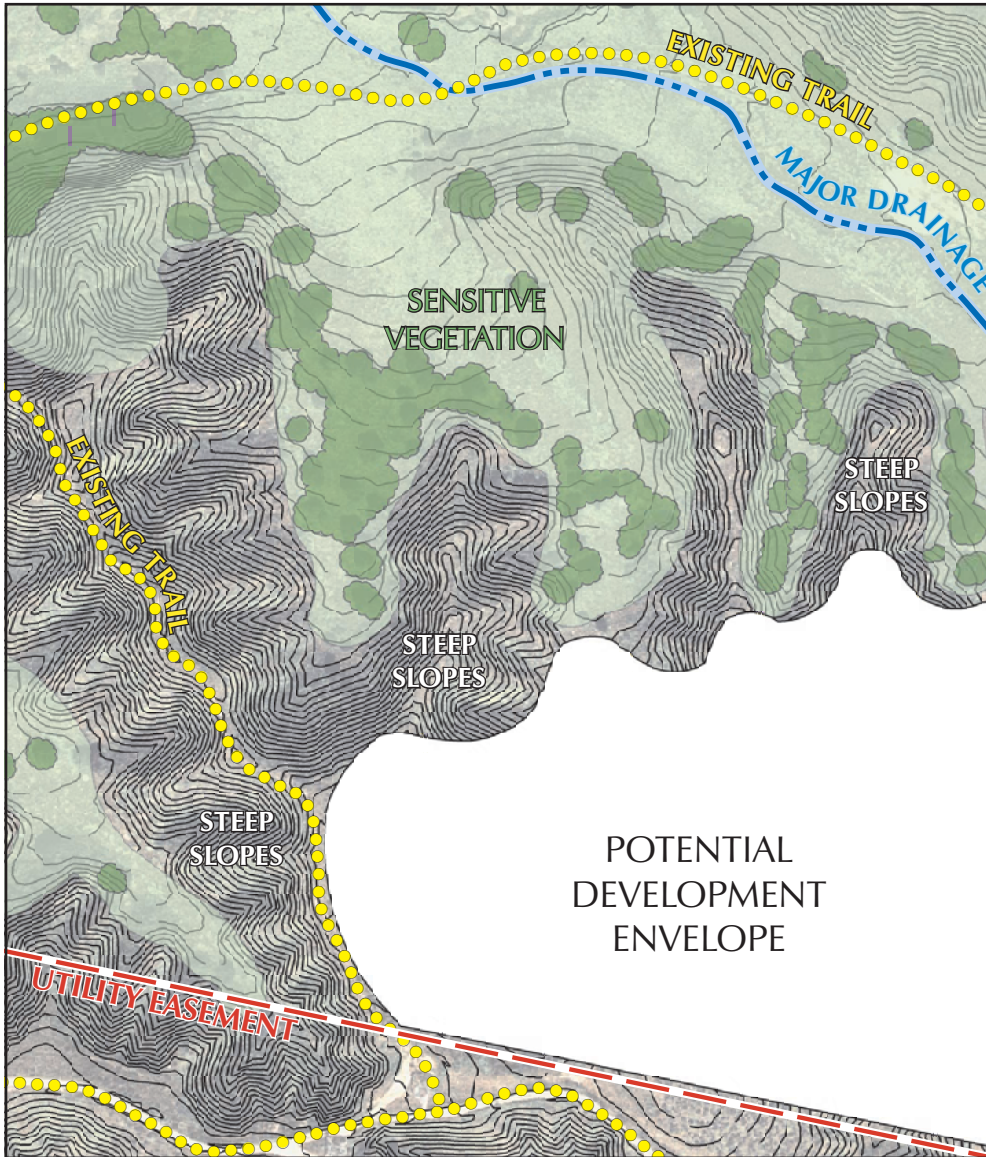

CLUSTERING TO PRESERVE ENVIRONMENTAL FEATURES

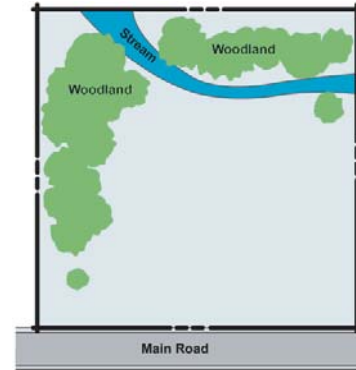

UNDEVELOPED LAND

- ◆ 5-acre parcel is comprised of nearly 2 acres of woodlands and a stream.

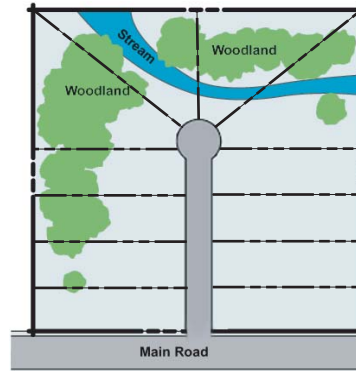

CONVENTIONAL SUBDIVISION

- ◆ All woodland and open space is covered by houselots or subdivision street without access to open space.
- ◆ Potential negative impacts to woodlands and water quality of stream.
- ◆ Increased visual impact of large lot suburban development versus smaller village cluster.
- ◆ Twelve 18,000 sf lots.
- ◆ No common open space.

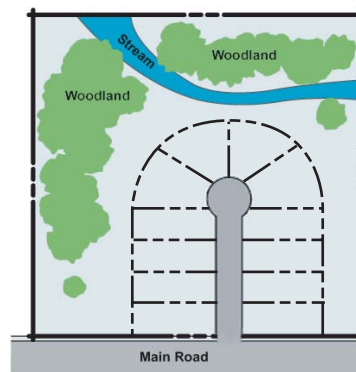

CLUSTER SUBDIVISION

- ◆ Slightly shorter road results in lower maintenance costs.
- ◆ Reduces disturbance of natural landscape; less impact to woodlands, and stream corridor is preserved.
- ◆ Each resident has a smaller lot; however, residents have access to a network of open space for active and passive recreation.
- ◆ Twelve 6,000 sf lots; 2 acres developed.
- ◆ 3 acres/60% open space.

SUMMERWIND RANCH AT OAK VALLEY

Specific Plan Area No. 1,
Amendment No. 1



FIGURE IV-1
Clustered Development Concept

□ **Residential Site Plan Concept**
Manors and Villas

This portion of residential land use is intended to provide areas for single family, larger lot subdivisions to be developed in the hilly and/or steeper sloped terrain of the project. This land use allows for design flexibility and minimizes the disruptions of grading and vegetation removal through selective building site location. In this manner, much of the visual and sensitive environmental areas of the site will be protected.

Buildings shall be sited to face neighborhood streets, natural open space areas, and parks. Varying front street elevations shall be used in siting homes along residential streets. Homes with side or rear elevations facing streets or other public spaces (such as linear parks or trails) shall have architectural detailing similar to the level of detail applied to the front of the home. Varying setbacks, building heights, and roof planes should be considered to provide more interesting visual character along neighborhood streets. Convenient access to public trails and open space areas should be incorporated into the neighborhood design. Neighborhood design should also utilize varied driveway locations and garage orientations to break up repetitive curb cuts and yard patterns. Smooth and logical transitions between residential product types should be provided.

In keeping with the desired character of traditional neighborhoods, homes on corner lots shall be designed and articulated for a two-sided corner exposure to enrich the street scene. Architectural forms should be adaptable to corner situations and some floor plans shall allow for garages on a separate street frontage from the entry. Homes on corner lots shall incorporate additional side yard setback width to create greater separation between the building and the sidewalk.

Homes on “icon” lots, or those lots that are situated in more prominent and visible areas of the neighborhood (typically on corner lots), are encouraged to incorporate special architectural features, raised pad elevations, and/or wrap around porches. The purpose of an “icon” lot is to showcase the architecture and quality of design encompassed throughout the neighborhood.

Figure 4-2, *Residential Site Plan Concept – Manors and Villas* illustrates these concepts.

TABLE 4-1
MANORS AND VILLAS RESIDENTIAL DEVELOPMENT STANDARDS

<i>Development Standards</i>	<i>Applicable Planning Area</i>	
	A4, B6, C2, C4, C9, D8	A3, A6, A7, B7, B9, C3, C8, C10, D11
Minimum Net Lot Area	7,200 sf	6,000 sf
Min. Pad (building site)	3,600 sf	3,000 sf
Uses Permitted	SFD	SFD
LOT DIMENSIONS		
Min. Lot Frontage*	40 ft	40 ft
Min. Avg. Lot Width	60 ft	45 ft
Min. Lot Depth	100 ft	100 ft
Min. Pad Size (WxD)	60x60	50x60
SETBACKS		
Minimum Front Yard	20 ft avg.	20 ft avg.
Minimum Corner Side Yard	10 ft	10 ft
Minimum Interior Side Yard	5 ft	5 ft
Minimum Rear Yard	20 ft	20 ft
Garage Setbacks (side-on/front-in)	20 ft/16 ft	20 ft/16 ft
Patio Covers (post/overhang)	5 ft/ 3 ft	5 ft/ 3 ft
Maximum Height	40 ft, or two stories, whichever is less	
Minimum Dwelling Size	2,000 sf	1,800 sf

* Except at cul-de-sacs

The design objectives for these neighborhoods are as follows:

- Create unusual and articulated exterior elevations and private spaces. The varied building massing and front yard setbacks allow for enhanced architecture and improved street scenes.
- Down-play the visual impact of garages on the street scenes. Varied garage conditions are required.
- Each floor plan is required to have at least three distinctive architectural elevations, thus allowing a variety of architectural details, forms, and character to develop.
- Allow building architecture to project forward along the street to pronounce the effect of the distinctive architectural styles.
- Provide a diversity of living square footages adaptable to a variety of market buyers, as well as a minimum two-car garage.



SUMMERWIND RANCH AT OAK VALLEY

Specific Plan Area No. 1,
Amendment No. 1



Residential Site Plan Concept - Manors and Villas (3-4 DU/AC)

FIGURE IV-2

PAGE IV-8

□ **Residential Site Plan Concept**
Cottages and Bungalows

Development under this residential category is intended for the smaller, single-family detached lot neighborhoods. These neighborhoods shall share many of the characteristics of the previous site plan concept description, but are more dense and may include zero lot line setbacks. Figure 4-3, *Residential Site Plan Concept - Cottages and Bungalows* illustrates these concepts.

TABLE 4-2
COTTAGES AND BUNGALOWS RESIDENTIAL DEVELOPMENT STANDARDS

<i>Development Standards</i>	<i>Applicable Planning Area</i>	
	A8, B5, B10, C5, D4, D7, D10	A1, B3, B11, D6
Minimum Net Lot Area	5,000 sf	4,200 sf
Min. Pad (building site)	2,400 sf	1,800 sf
Uses Permitted	SFD	SFD
LOT DIMENSIONS		
Min. Lot Frontage*	40 ft	35 ft
Min. Avg. Lot Width	60 ft	45 ft
Min. Lot Depth	100 ft	85 ft
Min. Pad Size	40x60	30x60
SETBACKS		
Minimum Front Yard	10 ft avg.	10 ft avg.
Minimum Corner Side Yard	10 ft	10 ft
Minimum Interior Side Yard	5 ft	Variable
Minimum Rear Yard	20 ft	15 ft
Garage Setbacks (side-on/front-in)	20 ft/10 ft	20 ft/10 ft
Patio Covers (post/overhang)	5 ft/ 3 ft	5 ft/ 3 ft
Maximum Height	40 ft, or two stories, whichever is less	
Minimum Dwelling Size	1,400 sf	1,200 sf

The design objectives for these neighborhoods are as follows:

- Create unusual and articulated exterior elevations and private spaces. The varied building massing allows for enhanced architecture and improved street scenes.
- Down-play the visual impact of garages on the street scenes. Varied garage conditions are required.
- Each floor plan is required to have at least three distinctive architectural elevations, allowing a variety of architectural details, forms, and character.
- Allow building architecture to project forward along the street to pronounce the effect of distinctive architectural styles.
- Provide a diversity of living square footages adaptable to a variety of market buyers, as well as a minimum two-car garage.
- Ensure a sense of privacy between residential units by properly orienting the locations of windows and doors.

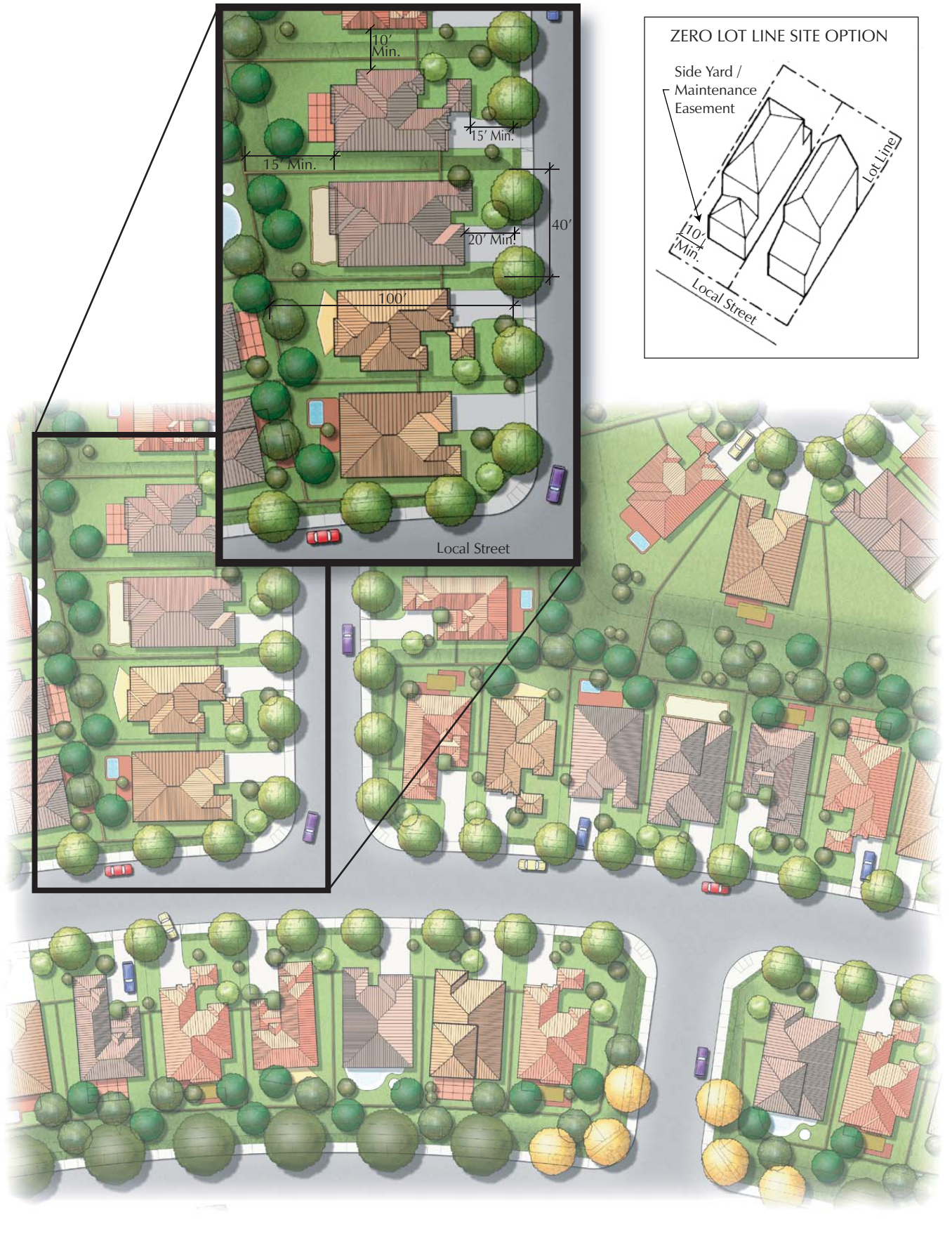

SUMMERWIND RANCH AT OAK VALLEY

Specific Plan Area No. 1,
Amendment No. 1



FIGURE IV-3
Residential Site Plan Concept -
Cottages and Bungalows (5-6 DU/AC)

□ **Residential Site Plan Concept**
Garden Courts

The *Garden Court* neighborhoods at SUMMERWIND RANCH AT OAK VALLEY are intended to obtain a higher density land use, while maintaining the detached, single-family architectural building style. These neighborhoods are an innovative form of housing and typically consist of a series of four to six detached units clustered around a common driveway or green court, each with private open space areas and entrances. Private open space areas may consist of side yards, small rear yards, or patios. Entries to the residential units may face either the local street, private driveway, or be grouped around a central green shared by all residents within the cluster.

Figure 4-4, *Garden Court Site Plan Concept* illustrates these concepts.

Garden Courts consist of common driveways or alleys that lead to the garages for each cluster of homes. Landscaping will be used to enhance the driveways or alleys and should complement the landscaping that is used in other areas such as the front yards and shared greens.

One of the major goals of the site planning guidelines for the *Garden Courts* is to create more of a “small village” and less of a mass produced feel. This goal shall be achieved through a diversity of style, smooth transitions between buildings, and increasing neighborhood landscape and hardscape.

TABLE 4-3
GARDEN COURTS RESIDENTIAL DEVELOPMENT STANDARDS

<i>Development Standards</i>	<i>Applicable Planning Area</i>
	B2, D3, E1
Minimum Net Lot Area	3,000 sf
Min. Pad (building site)	1,500 sf
Uses Permitted	SFD/Courtyard
Min. Lot Frontage	35 ft
Min. Avg. Lot Width	35 ft
Min. Lot Depth	80 ft
Min. Pad Size	30 x 50
Minimum Front Yard	10 ft avg.
Minimum Corner Side Yard	10 ft
Minimum Interior Side Yard	Variable
Minimum Rear Yard	15 ft
Garage Setbacks (side-on/front-in)	20 ft/10 ft
Patio Covers (post/overhang)	5 ft/ 3 ft
Maximum Height	40 ft
Minimum Dwelling Size	1,200 sf



SUMMERWIND RANCH AT OAK VALLEY

Specific Plan Area No. 1,
Amendment No. 1



FIGURE IV-4
Garden Court Site Plan Concept

The design objectives for Garden Court neighborhoods are as follows:

- Create unusual and articulated exterior elevations and private spaces. The varied building massing allows for enhanced architecture and improved streetscenes.
- Down-play the visual impact of garages on the streetscenes by utilizing common driveways or alleys.
- Each floor plan is required to have at least three distinctive architectural elevations, thus allowing a variety of architectural details, forms, and character to develop.
- Allow building architecture to project forward along the street to pronounce the effect of distinctive architectural styles.
- Provide a diversity of living square footages adaptable to a variety of market buyers, as well as a minimum two-car garage.
- Ensure a sense of privacy between residential units by properly orienting the locations of windows and doors.

□ **Residential Site Plan Concept**
Townhomes

The *Townhome* neighborhoods of SUMMERWIND RANCH AT OAK VALLEY are based on a unique design character derived from timeless building principles. The townhomes that result shall be crafted to meet consumer aspirations and take advantage of the close proximity of the town center. One of the major goals of the site planning guidelines for the *Townhomes* is to create more of a “small village” and less of a mass produced feel. This goal shall be achieved through a diversity of style, smooth transitions between townhome structures, and increasing neighborhood landscape and hardscape.

Townhomes are a traditional form of housing where each unit has its own private open space and entrance. Townhomes are attached at their sides, usually in groups of three or more homes. Resident parking and garages are typically set to the rear of units to avoid a series of blank garage doors along the associated street and pedestrian paths. Since there are few side yards and garage doors along the street, townhomes create pleasant and well defined streets and open spaces. By the very nature of the product, attached townhome neighborhoods are much like the “small village” described above and as illustrated conceptually on Figure 4-5, *Townhome Site Plan Concept*. Each townhome should be designed for compatibility within itself, using a blend of building types, compatible architectural styles, and a balanced palette of colors and materials to avoid clashing and achieve a restful uniformity within each small village.

TABLE 4-3
GARDEN COURTS RESIDENTIAL DEVELOPMENT STANDARDS

<i>Development Standards</i>	<i>Applicable Planning Area</i>
Minimum Net Lot Area	4,200 sf
Min. Pad (building site)	1,500 sf
Uses Permitted	SFD/Courtyard
Min. Lot Frontage	35 ft
Min. Avg. Lot Width	35 ft
Min. Lot Depth	80 ft
Min. Pad Size	30 x 50
Minimum Front Yard	10 ft avg.
Minimum Corner Side Yard	10 ft
Minimum Interior Side Yard	Variable
Minimum Rear Yard	15 ft
Garage Setbacks (side-on/front-in)	3 ft
Patio Covers (post/overhang)	5 ft/ 3 ft
Maximum Height	50 ft
Minimum Dwelling Size	800 sf

The design objectives for these neighborhoods are as follows:

- Residential buildings shall have a strong physical relationship to public areas and pedestrian paths.
- Emphasis on pedestrian access and connections to public sidewalks, trails, and community facilities.
- Create a sense of individuality by staggering, angling, or otherwise offsetting buildings to provide privacy at entries, patios, and balconies.
- Design buildings that vary, yet shall be of the same overall architectural theme through the use of complementary design elements. Provide a diversity of living square footages adaptable to a variety of market buyers, as well as a minimum two-car garage.
- Ensure a sense of privacy between residential units by properly orienting the locations of windows and doors.

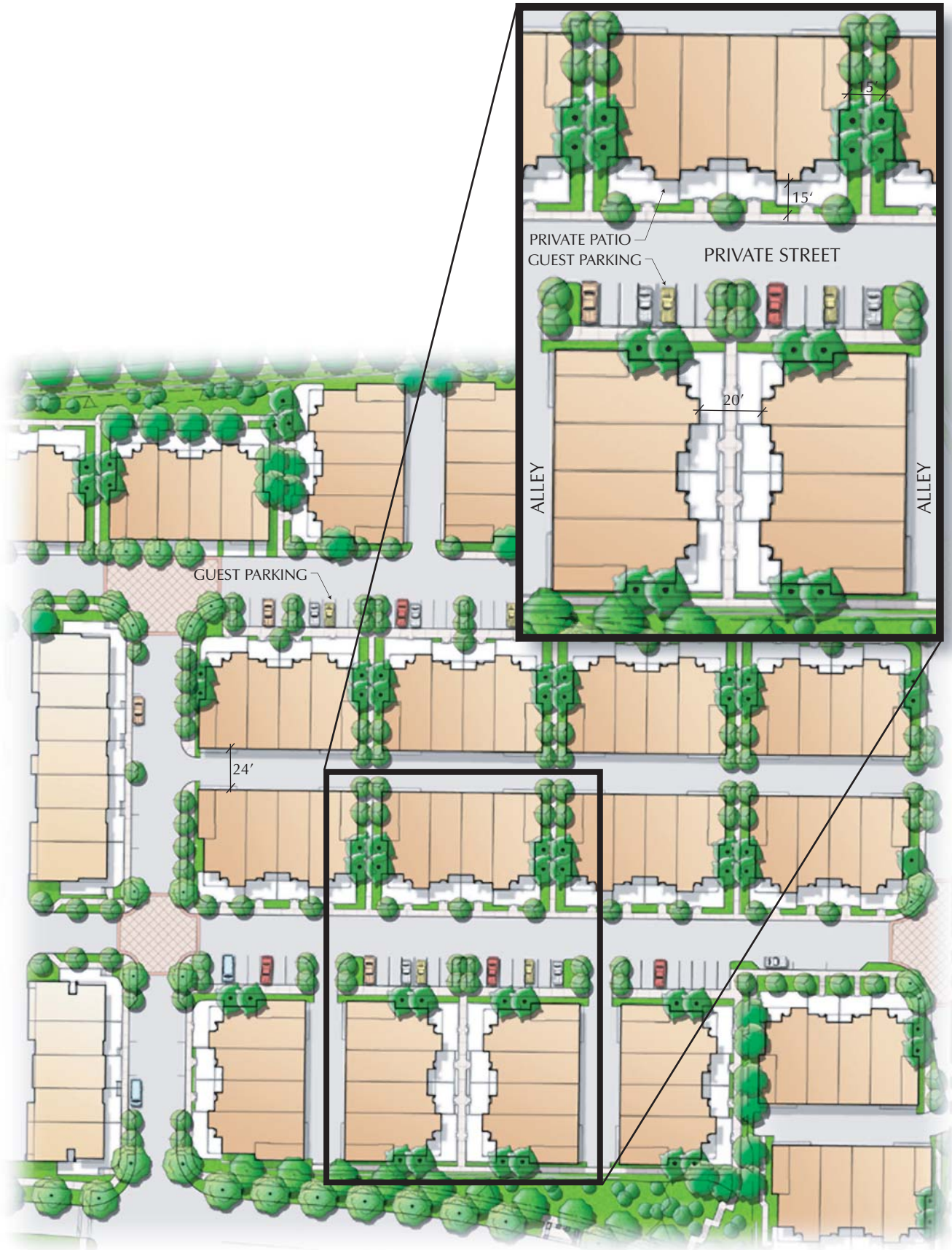

SUMMERWIND RANCH AT OAK VALLEY

Specific Plan Area No. 1,
Amendment No. 1



FIGURE IV-5
Row Townhomes Site Plan Concept

4. Architectural Styles

The sub-sections detailed in the following text describe the architectural guidelines for each of chosen historic architectural styles within the community. The architectural styles utilized in residential developments should have essential design elements for the styles incorporated into the exterior design. They should also ensure that building themes stay true to the chosen architectural style. Diverse elements from different styles should be avoided. Neighborhoods should include varied colors, materials, and texture treatments appropriate to residential architectural style and incorporate projections, recesses, and overhangs to provide shadow and depth. Exterior finish materials such as metal or aluminum siding and roofing, reflective materials, and concrete block are not allowed. Identical styles and colors shall not be used on homes adjacent to or facing one another. Materials and colors must be appropriate to the architectural style to add character and variety, while reducing, or breaking up the mass of the building.

The architectural design guidelines consist of written summaries and graphic exhibits which address the design development of specific and typical project areas that comprise the community concept. They are intended to provide guidance for the expression of development in the community. An eclectic mix of architecture is the design intent allowing both diversity and aesthetic appeal throughout the community. The varied architectural styles proposed will add a sense of nostalgia through this aesthetic diversity.

Developers, builders, engineers, architects, landscape architects and other design professionals are encouraged to use the guidelines in order to maintain design continuity, create an identifiable image, and develop a cohesive community. While there are several pictures and examples depicting architectural styles, they are only intended to show a variety of design solutions. These examples are not intended to require these precise themes. Rather they are intended to provoke design ideas that ultimately produce a community of design quality and cohesiveness. The master developer will setup a Design Review Committee that will be reviewing all merchant builder designs to insure that community design and value will be maintained. The Design Review Committee will work with the merchant builders of each phase to develop architectural themes, colors and street scenes that are compatible. The intent will be to develop these themes for each of the construction phase of the project, based upon the current market needs and trends.

This section brings to light certain key architectural and site design elements that would be encouraged in all residential and commercial development. In terms of the architectural expression of SUMMERWIND RANCH AT OAK VALLEY design elements will be based upon Craftsman/Bungalow, American Farmhouse, California Ranch, Prairie, Monterey, and French Country design themes. Examples of residential themes are shown here. These examples are only conceptual in nature and do not necessarily depict the actual final design. Finalized floor plans and elevations will be determined at a later stage of development, although suggested floor plan concepts for the various lot programs are shown. Conceptual plans developed for the housing programs are required to be submitted for review by the design review team administered by the master developer. Designs will be reviewed using the design guidelines prior to their approval for the design drawings and construction documents. Conceptual floor plans and four sided elevations developed for the housing programs are required to be submitted for review by the design review team.

□ **Architectural Style #1**
Craftsman Bungalow

The Craftsman Style, an American architectural style, represented a philosophy of life that featured honesty, integrity and a return to nature. The Craftsman design focuses on the harmony of indoor and outdoor life. It stresses honesty of form, materials and workmanship, eschewing applied decoration in favor of the straight forward expression of the structure. Craftsman architecture draws from the wood building traditions of Japan and Switzerland, as well as medieval themes favored by the Arts and Crafts philosophies. Natural woods, shingles, earth tone colors, brick, stone, river rock, clinker brick, and heavy structural beams signify oneness with nature. Rocks and bricks are often used on foundations, chimneys, and railings to set a unifying theme for the home. Wherever possible, aesthetic and functional interiors are integrated in simple living spaces. Southern California is the true home of the Craftsman Bungalow which was conceived by two brother architects, Charles and Henry Greene of Pasadena. These easy, asymmetrical gabled, stuccoed works of art are a large part of Southern California's architectural heritage.

The Craftsman architectural style is typically characterized by low pitched gabled roofs occasionally hipped with wide, enclosed eave overhangs. The roof rafters are usually exposed and decorative (false) beams or braces commonly are added under the gables. The primary wall form relies on a simple "box" orientation adorned with detailing such as wall articulation, unique window locations, large eave overhangs and porches. The use of exposed rafter tails beneath large overhanging eaves supported by projecting brackets is common. Façade surfaces are typically composed of shingles and wood lap siding. The limitless combinations of these elements can enhance the street scene and create a unique resident identity. Large covered front porches typically dominate the streetscape and commonly consist of two large pillars, broad at the base and tapering as they extend upward, supporting the large front porch gable. Windows are commonly double sash or casement type often tripartite or in clusters of three.

The more modest California Bungalow emerged as a solution to the need to build houses quicker and at more reasonable costs to keep pace with Southern California's rapid population growth. California Bungalows are similar to the Craftsman Bungalows in terms of scale, low-pitched roof, front porch, and exposed building elements. The main distinguishing features are that California Bungalows are typically less ornate.

The essential elements of design for this style are:

- A. Shallow pitched roofs with deep overhangs
- B. Deep, broad porch elements with expressive structural components such as square, or tapered columns
- C. Expressive structural elements such as rafters, brackets, braces and columns

- D. A mixture of materials such as stone, shingles and wood siding
- E. Asymmetrical massing and window and door compositions

Figure 4-6, *Typical Architectural Style #1 – Craftsman Bungalow* depicts examples of this style.

□ **Architectural Style #2**
American Farmhouse

The American Farmhouse style is typically characterized by wrapping front porches with a variety of wood columns and railings. The asymmetrical cottage look may be used. Dormers and symmetrical elevations can also be thematic for the elevation. Characteristic details are cupolas, weathervanes, dovecotes, vertical windows with shutters, wood potshelves, siding and gable end vent details. The massing is simple with gable roofs and may include either shed or side hip roofs occurring over the first floor porch. The American Farmhouse represents a practical and picturesque country house. Farmhouse architecture drew from Colonial styles from both New England and later the Mid-west. As the American Frontier moved westward, the American Farmhouse style evolved with the availability of materials and technological advancements, such as balloon framing. Wood railings and columns and single hung multi-paned windows in front are also common characteristics.

The essential elements of design for this style are:

- A. Simple gable roof forms both perpendicular and parallel to the front elevation.
- A. Broad porches covered by shed roof forms.
- B. Simple two story massing forms broken only by covered porches and gables.
- C. Exterior materials are predominantly wood siding.

Figure 4-7, *Typical Architectural Style #2 – American Farmhouse* depicts examples of this style.



Exposed Rafter
Tails

Low Pitch Roof &
Deep Overhangs

Truncated
Columns

Front Porch



SUMMERWIND RANCH AT OAK VALLEY

Specific Plan Area No. 1,
Amendment No. 1

T&B PLANNING CONSULTANTS
17332 East 17th Street, Suite 100, Tustin, CA 92780
(714) 964-8800 | (714) 964-8801
www.tbplanning.com

FIGURE IV-6
Typical Architectural Style #1 -
Craftsman/Bungalow



Simple Gabled Roof—
Forms Both Perpendicular
and Parallel To The Front Elevation

Predominant Use of
Wood Siding For External
Material



Simple Two Story
Massing Broken By
Broad Porches
Covered By Shed or
Side Hip Roof Forms

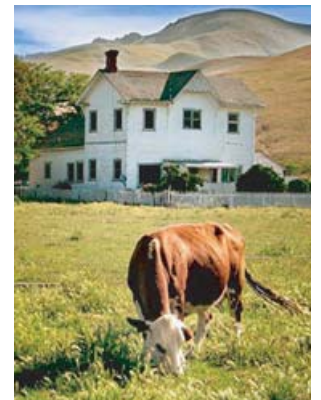

SUMMERWIND RANCH AT OAK VALLEY

Specific Plan Area No. 1,
Amendment No. 1



FIGURE IV-7
Typical Architectural Style #2 -
American Farmhouse

□ **Architectural Style #3**

California Ranch

California Ranch style is indigenous to California and is loosely based upon early Spanish California architecture with influences based upon the horizontal Prairie style. The general character of California Ranch style is derived from the Mediterranean, Bungalow, and 1940's Ranch styles. It consists of one and two story volumes with hip and gable roofs. Roof pitches vary from 4:12 to 5:12 with moderate to broad overhangs or eaves. Typical exterior wall cladding includes clapboard (horizontal boards), board and batten (vertical boards), shingles and stucco. Indoor-outdoor relationships are accentuated by such elements as: large areas of glass, sheltered porches, greenhouse rooms and corner windows. Exposed beam ends and deep fascias are used with columns and piers to create strong shadow patterns. Private gardens, patios and pot shelves are typical.

The essential elements of design for this style are:

- A. One or two story volumes with hip and gable roofs.
- B. Exteriors typically of horizontal boards, vertical boards, shingles, or stucco.
- C. Attention to indoor-outdoor relationships.

Figure 4-8, *Typical Architectural Style #3 – California Ranch* depicts examples of this style.

□ **Architectural Style #4**

Prairie

The Prairie style, one of the few indigenous American architectural styles, refers to a group of architects in Chicago, Illinois at the beginning of the 20th century. Primary amongst them was Frank Lloyd Wright, under whom the Prairie School designs reached their apex. Echoing the uninterrupted horizontal lines of the American prairie, Prairie style homes are usually characterized by broadly pitched hipped roofs with deep overhangs; two stories in height, often with one-story wings; front porches with massive porch roof supports; and detailing which emphasizes the horizontal. Stately, strong and weighty proportions provide a massive, earthy feel. Windows are grouped in horizontal bands with vertical proportions. Stucco or wood siding with horizontal emphasis are predominant with brick, stone or concrete block detailing. Roofs are typically flat tile or slate, and colors are earth-tone with both light and dark shades. Figure 4-9, *Typical Architectural Style #4 – Prairie* depicts examples of this style.

The essential elements of design for this style are:

- A. Wide, overhang eaves.
- B. Two stories with one-story wings or porches.
- C. Feature ribbon windows – 3 or more.

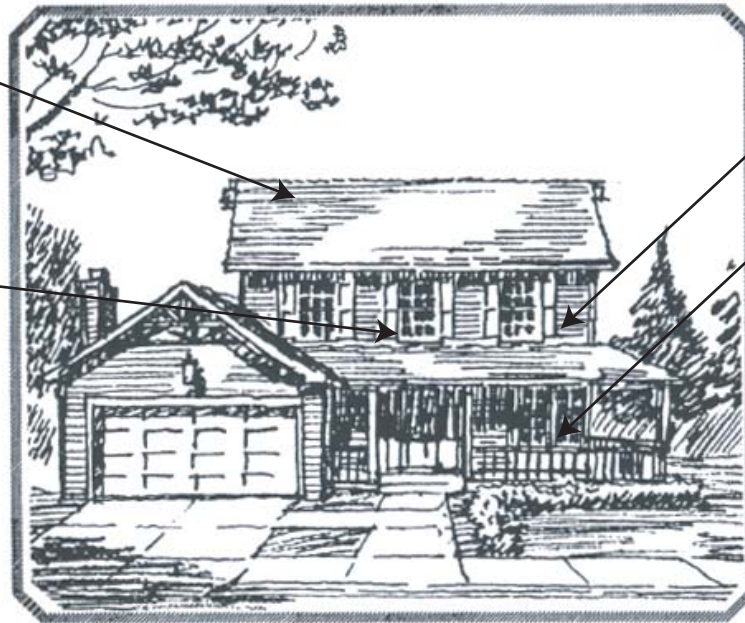

Low Pitched Roofs
With Moderate Deep
Overhangs

Wood Shutters With
Wood Trim on Windows

Wood Siding

Porch Entries



SUMMERWIND RANCH AT OAK VALLEY

Specific Plan Area No. 1,
Amendment No. 1



FIGURE IV-8
Typical Architectural Style #3 -
California Ranch



Low Pitched Roofs

Trapezoid Window Shapes or Simple Rectangle Shapes

Horizontal Banding in Brick, Plaster, Wood or Stone

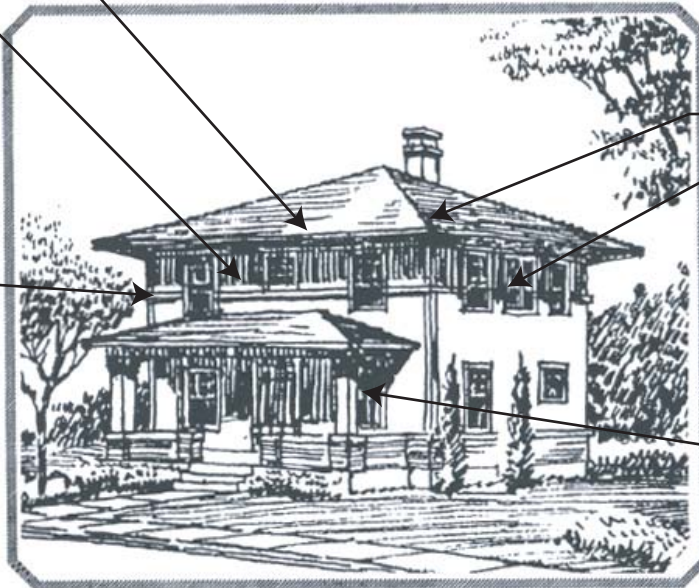

Hip & Gable Roofs

Vertically Proportioned Individual Windows Arranged in Horizontal Bands

Covered Breezeways



SUMMERWIND RANCH AT OAK VALLEY

Specific Plan Area No. 1,
Amendment No. 1



FIGURE IV-9
Typical Architectural Style #4 -

Prairie

- D. Broad-pitched, generally hipped roof.
- E. Eaves, cornices, and facades emphasize horizontal lines.
- F. Massive, square porch supports common.

□ **Architectural Style #5**

Monterey

The Monterey style is a revival of the Spanish Colonial houses of northern California, blending adobe construction with English shapes from New England. Monterey style houses always have a second-story balcony that is usually cantilevered and covered by the principle roof. Second story balconies traditionally are not located above living space. Roofs are usually tiled or shingled and the finish is generally smooth stucco, occasionally with wood siding as an accent. Multi-paned windows and large-scale chimneys are also often present on Monterey-style houses. Shaped rafter tails at feature areas are another element common to Monterey style houses.

The Monterey style of architecture is typically characterized by simple house forms, relatively low-pitched hip or gable roofs, and wide overhangs. Shutters, balconies, verandas and porches are indicative of the Monterey style. The first and second stories may have different cladding materials, with wood siding above and stucco or brick veneer base below. Walls convey a thick appearance with recessed door and window openings set back into smooth wall planes. The use of arches, courtyards, patios and colonnades enhance the theme.

The essential elements of design for this style are:

- A. Main roof is shallow hipped or gabled form intersected by front facing gables and often uses red tile roof covering.
- B. Broad porches or deep cantilevered second story balconies covered by shed roof forms.
- C. Simple two story massing forms reflect simple lines.
- D. Exterior materials are predominantly smooth finish stucco with horizontal wood siding on gable ends or second stories.
- E. Vertical window forms with multiple panes, often grouped.
- F. Expressive structural elements such as exposed rafter tails, wood corbels, decorative wrought iron accents, arched shapes around entries.

Figure 4-10, *Typical Architectural Style #5 – Monterey* depicts examples of this style.



Broad Porches or Cantilevered Second Story Balconies Covered by Shed Roof Forms

Vertical Window Forms with Multiple Panes, Often Grouped

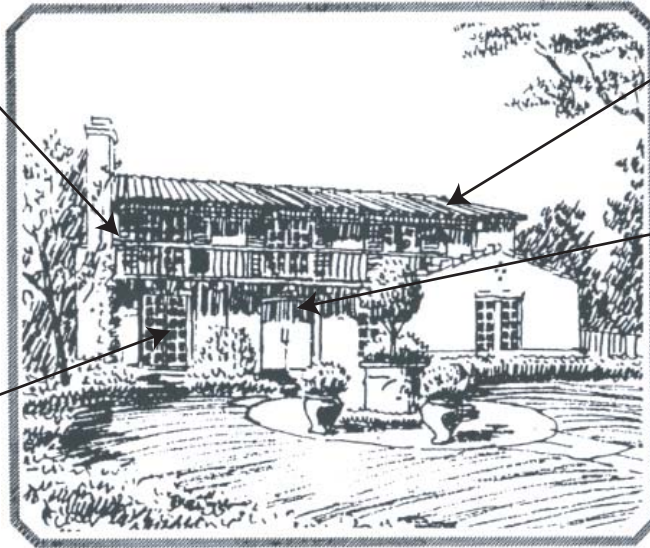

Shallow Hipped or Gabled - Often Uses Tile Roof Covering

Expressive Structural Elements such as Exposed Rafter Tails, Wood Corbels, Decorative Wrought Iron Accents and Arched Shapes Around Entries



SUMMERWIND RANCH AT OAK VALLEY

Specific Plan Area No. 1,
Amendment No. 1



FIGURE IV-10
Typical Architectural Style #5 -

Monterey
PAGE IV-26

□ **Architectural Style #6**
French Country

The French Country theme was developed in the 18th and 19th century France and was symbolic of the charm and character of rural France. The random elements and accents of this style express this distinct and appealing architectural character. A mixture of color, texture and materials draws upon the earth-tone shades of stone, brick and stucco to define this expressive character. Detail embellishment is a strong feature of French Country themes such as doors and windows with impressive trim or shutters, varying pitched roof lines, textured chimneys and wood or wrought iron balconies. The use of dormers and turrets are also used to enhance this style.

Balance and symmetry are the ruling characteristics of this formal style. Homes are often brick with detailing in copper or slate. Windows and chimneys are symmetrical and perfectly balanced, at least in original versions of the style. Defining features include a steep, high, hip roof; balcony and porch balustrades; rectangle doors set in arched openings; and double French windows with shutters. Second-story windows usually have a curved head that breaks through the cornice. The design had its origins in the style of rural manor homes, or chateaus, built by the French nobles.

The essential elements of design for this style are:

- A. Brick, stone or stucco siding.
- B. Dormers, hipped roofs, and flared eaves.
- C. Multi-paned windows.
- D. Decorative half-timbering.
- E. Often a round tower at entryway.
- F. Arched doorway.

Figure 4-11, *Typical Architectural Style #6 – French Country* depicts examples of this style.



Multi-paned
Windows



Dormers, Hipped
Roofs, and
Flared Eaves

Brick, Stone or
Stucco Siding



SUMMERWIND RANCH AT OAK VALLEY

Specific Plan Area No. 1,
Amendment No. 1



FIGURE IV-11
Typical Architectural Style #6 -
French Country

5. Building Mass and Scale

Building mass and scale are two of the primary design components used to establish appealing communities and personable neighborhoods. Controlling the mass of a building through design articulation of the building facades, attention to rooflines and variation in vertical and horizontal planes effectively reduces the visual mass of a building and ensures that building mass does not overwhelm the street. The exterior mass and form of residential buildings can be modified to improve the streetscene by controlling the impact of residential units as they relate to building setbacks, street corners and adjacent structures. The use of varying heights and variety of buildings along the street is encouraged to improve the look of a streetscene so that there is not a monotonous repetition of similar buildings.

Every opportunity should be considered to improve the visual relationship between adjacent buildings. A single-story architectural element within the two-story building can be used to lessen its height, or a combination one and two story building can be plotted. Units located at street corners should have the single-story portions of their mass plotted towards the exterior side yard.

The offsetting of second story elements away from the property line is encouraged, to reduce the canyon-like effect between side lot lines of two story homes.

Offsetting the second-story mass can improve the appearance of the front yard streetscene. To achieve this desired effect, the second-story should be set back in relation to the garage face below it.

Multi-family housing clusters shall be sensitively sited in order to maximize views and respond to site opportunities and constraints. These developments shall also provide outdoor recreation facilities as a reprieve to residents. The combination of structure placement and landscaping shall be arranged to make the development blend with its surrounding environment.

Within each use, ground floor continuity in architecture, articulation and detail should be maintained to facilitate a strong image and pedestrian friendly environment. The design should incorporate simple one-story and two-story volumes reflective of the selected architectural style and articulate forms within the building mass to provide delineation in the façade by incorporating design features and components appropriate to the selected architectural style. Homes should include rooflines that are “broken” to emphasize and articulate delineation in the building mass. Projections and recesses should be used to provide shadow and depth. Designs should consider angles within the floor plan (if appropriate to the architectural style) for visual interest and as an element of contemporary form. Extensive lengths of horizontal architecture will be controlled through the use of U-shaped building plans, side-on garage placement, front yard arrival courts and auto courts. Covered front porches, balconies and loggias, walkways and porte-cocheres will be utilized if appropriate to the selected architectural style. Stairs, balconies, porches and patios will be integrated into the overall design of the building and skylights, if any, will be integrated into the roof form. “Bubble” skylights are not acceptable. The proportion and material of chimneys should fit into the appearance of the roof. Each building in the multi-family and attached housing projects should include its own individual identity. This can be accomplished by individually articulated entries, offsetting and staggering units and/or by combining one and two-story building forms to separate

massing. Building lines should emphasize horizontal elements and roof lines. Combining one and two-story elements is encouraged. Articulation of architecture is required. The height and bulk of buildings should relate to the size, shape and topography of the site. Buildings should incorporate strong simple massing with broken and varied elements. The height and bulk of buildings should not block views and solar access of adjacent and other nearby buildings. Figure 4-12, *Building Mass & Scale* depicts examples of this.

6. Building Materials and Colors

Exterior building materials shall be of indigenous looking materials which are consistent with and reflect the natural character of the surrounding hillside environment. This includes wood, brick, masonry, concrete, stucco or plaster and stone.

Color is intended as a primary thematic element of the community. Consequently, the building material colors need to be compatible with the indigenous elements of the environment. Accents are encouraged which are darker or lighter to highlight the character of the structure; bright or non-earth tone colors should be avoided except as accents. Monochromatic color schemes are not allowed and buildings are encouraged to have at least three colors for the body, wainscoting, trim and fascia. Colors chosen should apply to the themes they represent.

Building materials and colors are important elements when used to achieve a true representation of a specific architectural style. Each structure should have a different predominant façade material or color than the immediately adjacent structure to promote individuality within the neighborhood context. The project will utilize various siding materials to produce effects of texture and relief that provide character and consistency appropriate to the architectural style. Any changes in material should occur at changes in plane and foster an appearance that is substantial, integral and complete. Material changes not accompanied by changes in plane also frequently give the material an add-on appearance. Exterior finish materials such as metal or aluminum siding and roofing, reflective materials and unfinished concrete block are not acceptable. Building materials and colors shall complement the natural, climatic and built environment of SUMMERWIND RANCH AT OAK VALLEY. Whenever possible, materials should be durable and require minimal maintenance. Paints, stains and stucco should, in most cases, be limited primarily to soft pastels, neutral colors, grays, and earth tones. Color schemes should be appropriate to the architectural concept chosen. Accent colors and pure hues should be used on moldings, doors, window frames, fascias, awnings, window boxes, shutters, cornices, and accent trim. Wood may be treated with transparent stains or paints if desired. Color palettes for each tract indicating a minimum of three colors per home is required, with a minimum of five palettes provided to achieve a variety of colors throughout each tract. All flashing and sheet metal should be painted or covered from view in a manner consistent with the general exterior architectural treatment of the building. Architectural screens, fences and accessory structures should be compatible in material, color and texture to the main buildings. Figure 4-13, *Building Materials & Color* depicts examples of this.



SUMMERWIND RANCH AT OAK VALLEY

Specific Plan Area No. 1,
Amendment No. 1

 T&B PLANNING CONSULTANTS
17011 East 17th Avenue, Suite 100, Denver, CO 80238
303.751.9100 | www.tbplanning.com



FIGURE IV-12
Building Mass & Scale

PAGE IV-31



SUMMERWIND RANCH AT OAK VALLEY

*Specific Plan Area No. 1,
Amendment No. 1*



7. Windows and Doors

Window and door details are architectural components that carry a strong visual impact through their placement and design. The proportion of the windows and doors to the wall massing varies according to the architectural style chosen.

Entrances should be clearly defined and inviting. Inset window glass from the exterior wall surface and/or provide with dimensional trim as a method of providing a sense of depth. Consider privacy of adjacent residences when locating windows. Window frames, mullions, awnings, and door frames are encouraged and should be color coordinated with the rest of the building. Architectural projections and recesses such as pop-out windows and doors, shutters, and pot shelves may be used to achieve articulation and shadowing effects. The front entry should be articulated through the use of roof elements, porches, columns, arches or other architectural features. Window details create an opportunity to provide contrasting trim colors. Multi-lite windows, clerestories, paned/side-lite doors, and shutters are encouraged where appropriate to the architectural style of the home. Figure 4-14, *Windows and Doors* depicts examples of this.

8. Porches and Balconies

The incorporation of front porches and front and rear balconies as part of the architectural vocabulary is encouraged for both aesthetic and practical reasons. Front porches or patios enclosed by low height walls are encouraged on all detached residential units. Front porches shall be covered with a roof that is supported by posts or other structural members (as opposed to cantilevered), and shall have railings or other decorative elements between posts. Wrap-around porches and/or patios defined by a low wall are encouraged on corner lots to provide visual interest on both street elevations. Figure 4-15, *Porches & Balconies* depicts examples of this.



SUMMERWIND RANCH AT OAK VALLEY

*Specific Plan Area No. 1,
Amendment No. 1*

T&B PLANNING CONSULTANTS
17521 East 17th Avenue, Suite 100, Aurora, CO 80013
P: 774.589.4362 F: 774.519.8150
www.tbplanning.com

**FIGURE IV-14
Windows & Doors**

PAGE IV-34



SUMMERWIND RANCH AT OAK VALLEY

*Specific Plan Area No. 1,
Amendment No. 1*



T&B PLANNING CONSULTANTS
 17751 East 170th Street, Suite 100, Torrance, CA 90780
 P: 714.974.4403 F: 714.315.8345
 www.tbplanning.com

**FIGURE IV-15
Porches & Balconies**

9. Columns and Posts

Columns and posts are important design components in many of the suggested architectural styles for SUMMERWIND RANCH AT OAK VALLEY and are often signature elements to a particular style. Columns and posts should be incorporated as structural and aesthetic design elements and should be dimensioned appropriately so that a solid and durable image is conveyed. The scale and dimension of these elements varies depending upon the architectural style. The elements shall reflect the selected style when they are introduced in the design proposals. Figure 4-16, *Columns & Posts* depicts examples of this.

10. Garages

In a society geared to the automobile, the automobile's "housing needs" have come to be the predominant architectural element on many of the streets we live on today. Too often garages have been designed in a manner that detracts from the overall appearance of the neighborhood. A garage can tend to dominate the elevation of a small lot home if not dealt with adequately. This situation creates a repetitious streetscene that is dominated by garage doors which is undesirable from a visual perspective.

A variety of garage conditions with less prominent visibility solve this issue, such as recessed or backyard garages, tandem garages, side entry and split garages. Standard three car garages are encouraged to have at least one garage which is partially setback. Corner lots are encouraged to allow garage entries from intersecting streets, with wrap around architecture. Installation of single car garages can add variety and break up the front elevation. The garages can be recessed from the front plane to give a strong shadow line to help decrease the impact of doors. Proper color selection can minimize the impact of garages. A contrasting color, coordinated with the roof and trim gives an attractive appearance. Windows in the garage doors also add variety. Enhanced door design can give variety and interest to a garage. These doors could have texture and color added. Architectural elements of the home, such as arches or other features, can be duplicated on garages to give unity to the front elevation. By using decks and balconies, the visual interest can be drawn to these features to break up the façade and de-emphasize the garage. Minimize the garage to emphasize other features such as the main entry and a feature window above one of the garages. By stepping the garage doors, garages become part of the series of interlocking masses. This helps to break up and give variety to the elevation. The rooflines can vary, and color and texture can be used in combination on the garages to create interest. Roll-up garage doors are required and shall be painted to match the architectural style and proposed color scheme.

Long and uninterrupted stretches of garage doors are discouraged. Garage facades should be softened utilizing landscape materials in the immediate vicinity. Residential garage doors visible from a street or public space shall consist of articulated panels. Dwelling units shall also incorporate living space or balcony space over the garage or creation of strong shadow lines around the garage door by recessing the door or extending a trellis at least 2 feet in front of the garage face. The building type and size of the home will dictate garage location, configuration and access. To encourage architectural interest and to reduce the emphasis of the garage along the street scene a mix of garage configurations should be incorporated into home design throughout the community. Many garages are recessed or pushed



SUMMERWIND RANCH AT OAK VALLEY

Specific Plan Area No. 1,
Amendment No. 1



FIGURE IV-16
Columns & Posts
PAGE IV-37

back on lots to avoid a street scene dominated by garage doors. These are accessed from a public street in the front of the home. They are attached to the residence but set back further from the street than the principal front elevation of the house. Conventional garages are accessed from a public street and are located closer to the street than the principal portion of the residence. Side drive garages can be either attached or detached from the residence and have a long driveway so that the garage can be placed toward the rear portion of the lot and further back from the street. Swing-in garages, or side-facing garages are located on the front portion of the lot and are attached to the residence, but the garage entry doors do not face the street. Architecture design shall vary the placement and orientation of garages. When garages are located on the front side of the house, it can be entered from the front or side, when lot size or corner location permits. Integrate detached garages and accessory structures (where provided) into the overall design of the project with similar materials and details. Garage doors should be recessed into the garage wall. Garage doors should be multi-paned or otherwise provided with subtle adornment to provide shadow relief. Decorative panels, windows, arched doorways or ornamental trim are strongly encouraged. Driveway design and placement in relation to drive locations on adjacent lots plays an important role in creating a quality street scene. Driveway widths should be minimized as much as possible within detached products. Figure 4-17, *Garages* depicts examples of this.



SUMMERWIND RANCH AT OAK VALLEY

Specific Plan Area No. 1,
Amendment No. 1



11. Rear and Side Articulation/Façade Treatment

The design consideration and treatment of the rear and side facades of residential buildings, particularly those facing onto community streets, parks and open spaces, has become recognized as an important element in the success of a community's visual character and environment.

For interior and side yards, it is desirable to create the appearance of increased building separation whenever possible. Problems occur when setbacks are not varied or when second story elements are not offset. These conditions allow little light to penetrate between buildings and create the effect of a "canyon" within the side yards. In many cases, side yard slopes result in both vertical and horizontal separation that is sufficient to mitigate this concern. Where side yard slopes do not exist, one or more of the following solutions may be appropriate:

- Side elevations can be varied by stepping back the second-story at the side yard. This allows more light to penetrate and gives architectural interest and variety to yards. This can also be achieved by offsetting the garage in relationship to the balance of the unit.
- By providing single-story elements in the side-yard, such as a breezeway, porch, or single-story room off to the side of the structure that is only one-story in height, you create relief of the second-story massing.
- Reducing the roof height over an interior volume will increase variety and light penetration to the side yards. On the interior, this could be a cathedral ceiling, which would enhance the interior as well.

All rear elevations within the public view are required to have several enhancements to avoid the repetitious effect and avoid a monotonous visual appearance. Outlined are a few solutions to this problem:

- The overall look of an extensive row of residences can be modified by enhancing elevation window trim and placement. Giving variety to the windows on the façades gives variety to the overall streetscape.
- It is required to vary roof conditions from one building to the next through use of varied roof pitches and forms, different architectural styles, and varied lot setbacks.
- By articulating the rear elevation plan form, variety is given to the overall appearance. Architectural projections, balconies and trellises, and varied elevations contribute to the articulation of the form.
- Two-story homes that back to major roads shall have visible elements such as window trims, varied stucco applications, shutters and enhanced details.

All residential buildings that face an adjacent street should have articulated elevations. Articulation should be achieved with porches, balconies, or bay windows, or other features appropriate to the architectural style of the building. Street facing elevations on attached products shall have additive or subtractive architectural elements to help break up the mass of the building façade. Examples of additive elements include dormer windows, porches, bay windows, exterior stairs and similar features. Examples of subtractive elements include carved openings, niches, recessed windows and doors and similar architectural design features. At least 25% of a residential building's façade that faces a street

should be windows and doors (garage doors do not count towards this guideline). Where building elevations other than the front (street) elevation are visible from a side street or other public area, these visible elevations should have the same level of detail and articulation as the front elevation. Long blank, unarticulated façades are prohibited. Façades should be “divided” by vertical and horizontal variations in wall planes, building projections, door and window bays, and similar elements. Ensure that all residential structures possess articulated façades such as recesses, recessed openings, building separations, variations in plane and height, and the inclusion of elements such as balconies, porches, arcades and architectural projections consistent with the architectural style to provide depth and contrast and avoid flat, unarticulated building façades. Individual neighborhoods should reflect a diversity of distinct architectural styles prevalent in early 20th century neighborhoods, including: Craftsman Bungalow, Prairie, California Ranch, Farmhouse, Monterey, and French Country. Building heights should vary throughout the tract. Two story homes should include both one and two story elements as a part of their architectural design. For each floor plan, varying elevations should be provided to create visual interest and a varied neighborhood street scene. Where similar floor plans of the same unit are located on adjacent lots, it is suggested that one be a reverse plan and different in elevation from the other of the same plan. Building façades will have a minimum of two building planes on the sides and rear. Front porches, bays and balconies are encouraged along the front façade; the entry should be a focal point of the elevation and be readily discernable. Projections, offsets, overhangs and recesses should be used to create shadow, giving the building a sense of depth and substance. For side and rear elevations, design elements such as second floor window trim may be used to articulate otherwise blank wall planes. Variable garage setbacks should be used. Creative garage placement and design is encouraged. Garages should be integrated into the architecture and should not dominate the front façade. Figure 4-18, *Rear & Side Articulation* depicts examples of this.



SUMMERWIND RANCH AT OAK VALLEY

Specific Plan Area No. 1,
Amendment No. 1



FIGURE IV-18
Rear & Side Articulation

12. Roof Materials and Colors

Roof forms including hipped and gabled elements are encouraged. A variety of roof style shall be included within each neighborhood. Roof articulation should utilize vertical and horizontal articulation to introduce additional shapes, angles, and shadows and add visual relief to the tops of buildings. Roofs should also be designed as an integral component of the form of the building, its mass and façade. Roof articulation may be achieved by changes in plane or through the use of traditional roof forms, such as gables, hips and dormers, and through effective use of roof overhangs. Flat roofs and A-frame type roofs are prohibited. Finish roof flashings, rain gutters and downspouts, vents and other roof protrusions should match adjacent finish materials and/or colors. Unfinished galvanized metal is not acceptable. Variation in roof forms, colors, textures and materials shall be utilized to create an appearance of custom styles within each neighborhood. In addition, roof shingles and other roofing elements shall be made of fire retardant materials for all homes. Roof vents and accessories shall be positioned away from the street and/or finished to match the roof color to minimize visual impact. Roof pitches and forms may vary in order to encourage individual architectural expression. Steeper pitched roofs may be used as accent roofs to complement the street scene. To provide for a reduced scale along the street, single story plate lines along front and side yard setbacks are encouraged. Roof additions shall be of the same materials as main structures. Figure 4-19, *Roof Materials & Colors* depicts examples of this.

13. Accessory Structures

Accessory structures shall have roofs of similar and/or compatible materials as primary/major structure. There is no minimum roof pitch required for accessory structures. Flat roofs on accessory structures are permitted in all zones in SUMMERWIND RANCH AT OAK VALLEY.

The design of accessory structures (cabanas, storage sheds, etc.) shall be compatible with the main structure through the use of architecture, fence connections and/or landscaping. Recreational vehicles and trucks shall be stored in an enclosed area and out of view of any adjacent lot or road.

Solar panels, if used, shall be integrated into the roof design as an unobtrusive element. Panels are to be parallel to the roof plane and should be clear, bronze, or smoke colored plastic or glass. To the greatest extent possible, solar panels, satellite dishes, and other similar roof-mounted mechanical equipment should be located away from front elevation street views. Skylights may be incorporated into the roof design to provide natural light and passive solar energy. Frame color should blend with the surrounding roof color. Natural aluminum frames are not allowed.

14. Mailboxes

Installation of cast iron, cast aluminum, brick, or slumpstone-encased curbside mailboxes is required. Final type and location of mailboxes will be coordinated with United States Postal Service official at the tentative map level.



SUMMERWIND RANCH AT OAK VALLEY

Specific Plan Area No. 1,
Amendment No. 1

 T&B PLANNING CONSULTANTS
17012 San Diego Avenue, Suite 100, Irvine, CA 92614
P: 714.961.9400 F: 714.961.9347
www.thplanning.com

FIGURE IV-19
Roof Materials & Colors

PAGE IV-44

15. **Commercial Site Plan**

Commercial areas should be oriented in a pedestrian-friendly manner and provide both street-facing entrances as well as entrances which are easily accessed from the parking areas. The scale of the buildings and plan should be manageable and public spaces should be oriented in a usable manner. Ample parking is to be provided and laid out in such a way that areas are segmented and all connected by a main ingress and egress system so that the flow is continuous.

Landscaping, earth berms, decorative walls and other buffers should be used to reduce impacts on adjacent properties from commercial areas. Landscaping should be provided around the base of commercial structures to soften the edges between the parking areas and the structure. Figure 4-20 *Commercial Site Plan Concept* shows an example of this.

16. **Business Park Site Plan Concept**

The business park will be laid out in such a way that there is convenient access provided to those who use it, while avoiding an overbearing presence when the area is viewed from the street. The pedestrian should be kept in mind when designing this portion so that the scale is not overwhelming and the site can be easily accessed and navigated by people. Ample parking is to be provided and laid out in such a way that areas are segmented and all connected by a main ingress and egress system so that the flow is continuous. Landscaping should be used to lessen the visual impacts from the surrounding streets and to make public spaces within the business park more desirable. These concepts are shown in Figure 4-21 *Business Park Site Plan Concept*.

17. **Typical Commercial and Business Park Architectural Style**

Consistency of architectural character, form, detail and scale should be clearly evident in the design and execution of all buildings in the retail/commercial/business park portion of the community. Examples are provided in Figure 4-22 *Typical Commercial Architectural Style* and Figure 4-23 *Typical Business Park Architectural Style*.

18. **Commercial and Business Park Design Criteria**

Architectural Theme

The concept for commercial architecture is to keep with the residential architectural themes which are proposed for the residential community of SUMMERWIND RANCH AT OAK VALLEY. These styles include Craftsman/Bungalow, American Farmhouse, California Ranch, Prairie, Monterey, and French Country.

Design Principles

The intent of this project is to provide a framework which can integrate public and private construction over time, while maintaining maximum flexibility to accommodate a

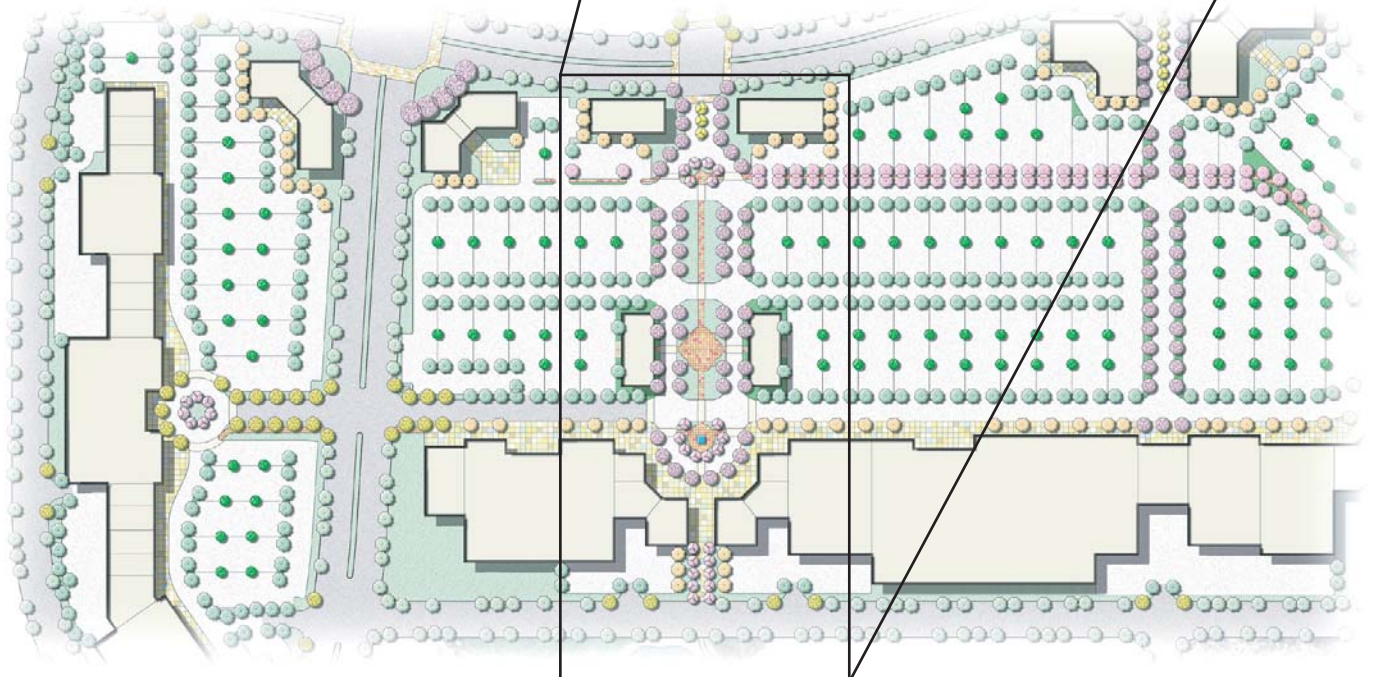
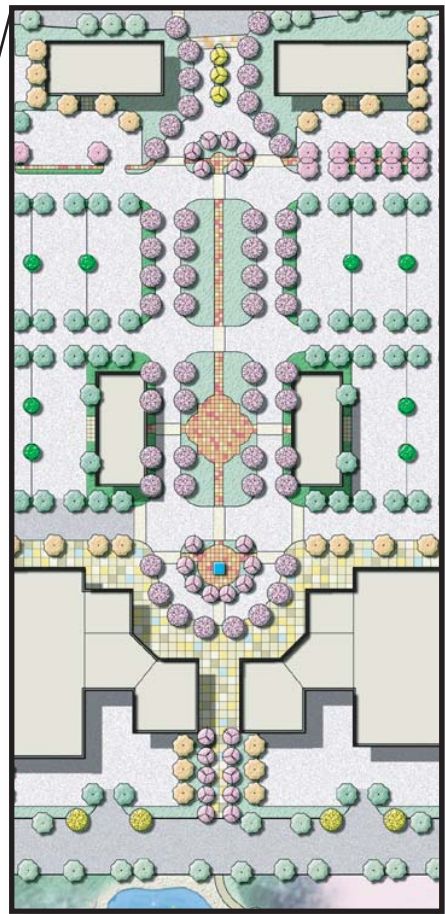

SUMMERWIND RANCH AT OAK VALLEY

Specific Plan Area No. 1,
Amendment No. 1

 T&B PLANNING CONSULTANTS
3712 San Luis Avenue, Suite 100, Union City, CA 94586
P 774.969.9600 F 774.305.8360
www.tbplanning.com



FIGURE IV-20
Commercial Site Plan Concept

PAGE IV-46



SUMMERWIND RANCH AT OAK VALLEY

Specific Plan Area No. 1,
Amendment No. 1

T&B PLANNING CONSULTANTS
17925 Euc. 17925 Street, Suite 100, Torrance, CA 90506
P 774.505.6160 F 774.505.6161
www.tbplanning.com





SUMMERWIND RANCH AT OAK VALLEY

Specific Plan Area No. 1,
Amendment No. 1

T&B PLANNING CONSULTANTS
17542 Van Tien Station, Suite 100, Tustin, CA 92780
© 2014 T&B Planning | 714.365.5947
www.tbplanning.com



FIGURE IV-22
Typical Commercial
Architectural Style

PAGE IV-48



SUMMERWIND RANCH AT OAK VALLEY

Specific Plan Area No. 1,
Amendment No. 1

 T&B PLANNING CONSULTANTS
17522 E. 17th Street, Suite 100, Tustin, CA 92780
P 714.305.4360 F 714.305.8345
www.tbplanning.com



FIGURE IV-23
Typical Business Park
Architectural Style

PAGE IV-49

wide variety of uses. The principles and guidelines are not intended to restrict taste or preference, but are designed to avoid harsh contrasts and to foster harmony of development throughout SUMMERWIND RANCH AT OAK VALLEY. Commercial buildings should be designed as a complementary addition to the overall theme established throughout the community. Dramatic departures in form, scale, and style are not permitted. Buildings should be designed to create smooth transitions in scale through the use of low and mid-rise building forms or through the use of terraced elevations. The uniform, large scale and mass of buildings should be softened by adding projections, pop-outs, arcades, and unique tower or rotunda forms. Long, uniform façades should be avoided by creating visual interest through the use of courtyards, varied building setbacks, arcades, windows and towers. There should be a focal point of special interest presented to the public view. Buildings should be designed to locate high activity uses, such as restaurants and entertainment facilities, adjacent to major pedestrian ways. Outdoor uses are strongly encouraged along pedestrian ways, as well as providing the highest level of detail and interest at ground level. Arcades, canopies, awnings and trellises are encouraged to define pedestrian ways to and to offer protection from the elements. Flags and banners can add significant interest and color to pedestrian ways with a minimum investment. Flags and banners should be made of durable cloth material and should be integrated into the overall planned sign program and architectural design of the project in which they are located. Signs should be designed to be complementary with and subordinate to the building they identify. Tenant signage shall be consistently integrated with the building façade and be of uniform shape and materials. All lighting and illuminated signs shall be located and designed in such a way to confine illumination to the premises. If parking structures are used, the ground floor should be accessible to retail and other pedestrian-oriented uses.

□ Building Mass and Scale

The massing and scale of buildings requires careful articulation since they will be perceived most dramatically from high image areas. There should be a mix of one-and-two-story mass and use of a focal vertical element within horizontal architectural forms. Elements such as projections and recesses to provide shadow and depth, stepped walls, and angles in plan and elevation for visual interest and as an element of contemporary form all provide more pleasing façades. Other characteristics that should be found in the construction of these commercial buildings are: balconies, columns, broad pitch and extensive overhang, hip/gable roofs, enclosed courtyards, archways, and bold vertical elements. Large expanses of flat wall planes, vertically or horizontally, and architectural massing and proportion not sympathetic to human scale should be avoided.

□ Building Materials and Colors

The commercial areas are an integral part of the overall community. The materials and colors should be compatible with the surrounding development. Color is intended to act as a primary theme-conveying element, and will be reflective of the architectural style.

Creating elevations that do not vary in plan should be avoided. It is recommended that the exterior walls have a varied setback creating an interesting building elevation or façade. The design should utilize significant architectural elements such as arcades, balconies or stairways to articulate the building façade, thus providing visual interest in

addition to creating pedestrian spaces. Clock towers or certain vertical elements can also be used as a focal point.

Exterior building materials shall be of natural character that would reflect the rural character of the surrounding environment. Contemporary materials are acceptable if they are compatible with the surroundings and are used for creating interest.

Color is intended as a primary theme element of the community consistent with indigenous elements of the environment. Accents are encouraged which are lighter or darker to highlight the character of the structure. Bright and non-earth tone colors are not encouraged except as accents.

☐ Roof Forms and Materials

Principal roof forms shall be gable or hip with pitches from 4:12 to 6:12. All roof material shall ensure continuity in texture, color and character to the architectural styles. The design should create interesting building masses by varying rooflines and by maximizing offsets to roof planes where possible. Combining single-story elements with two-story elements is encouraged. Flat roofs with parapet walls are acceptable but should also be used in combination with simple pitched gable, hip or shed roof forms.

Mechanical equipment on roofs shall be screened from view of highway, roadways and residential homes with materials consistent with those of the building.

☐ Windows and Doors

Recessed doors, windows and wall openings emphasizing massive wall thickness are characteristic elements of the allowed architectural styles. Fully recessed door and window openings are encouraged as well as embellished framing treatments of both to add articulation to the wall surface. Consideration should be taken to relate interior building design to pedestrian spaces through generous use of glazing in doors and windows. Other enhancements which are encouraged are: recessed windows and doors to create shade and wall articulation, arched windows and doorways, decorative treatments, accent trim or tile at doorways, banded windows to emphasize the horizontal, glazing which follows roof pitch, canvas awnings with complementary accent colors, and wrought iron accents. Silver or gold window or door frames, reflective glass or awnings, and metal awnings are all discouraged.

☐ Balconies and Handrails

The incorporation of balconies and porches as part of the commercial architectural style is encouraged for both practical and aesthetic value. They integrate indoor and outdoor spaces, break up large wall masses, offset floor setbacks, and add human scale to the buildings, by giving the impression of habitable space above commercial development, reminiscent of early plazas. The elements which will be allowed are covered porches and balconies, smooth stucco or wood, simple, clean, bold projections, wood trimmed details,

veranda style balconies with open railings, and wrought iron railings. Pipe railing is discouraged.

❑ **Exterior Stairs**

Simple, clean, bold projections of stairways are encouraged to complement the architectural massing and form of the buildings. These stairways should have enclosed or open railing, smooth stucco, wrought iron or simple wood railing, use of clay tile or brick as tread, use of accent tile on riser, balustrades, and pilasters.

❑ **Columns**

Columns incorporated as a structural or aesthetic design element shall convey a solid, durable image as expressed through bold forms. Columns may be used as a freestanding form or as a support for pedestrian links. Columns should be made of materials such as simple square posts, square or round stucco, or freestanding plaster archways at entrance gates. Exposed pipe columns and thin posts, such as metal pipe columns should not be used.

19. **Commercial Site Planning Criteria**

❑ **Design Principles**

The Site Planning Design Principles are not intended to restrict taste or preference but are designed to avoid harsh contrasts and to foster harmony of development. For example, within parking lots, all ingress and egress locations should be designed to reduce impacts on the existing circulation system. Large open parking lots should be divided into smaller, less imposing lots. Ground floors of buildings adjacent to major streets should be placed adjacent to the street edge to encourage pedestrian activity. Free-standing buildings are encouraged to be grouped around a common focal point or design feature. Open areas should be large enough to be usable, but not so large as to appear empty. Fifteen feet to thirty feet is generally appropriate. Major projects or individual buildings at key locations should incorporate public plazas at focal points and at activity centers. Use of water elements in selected areas is encouraged. Provide shade as much as possible. Plazas and courtyards are encouraged to be used as transition areas between public and private spaces. Continuity should be maintained through the use of unified or complementary pedestrian amenities, landscaping and similar design features. Alternative paving and bollards can be used to provide for separation of pedestrian and vehicular circulation within the same right-of-way.

Streetscene

The project needs to provide adequate separation between parking and storefronts to allow for comfortable pedestrian spaces. The distance along the face of the building should be varied to provide visual interest. Loading zones shall be site planned to avoid exposure to adjacent streets, highways and residential zones. Incorporating walls and fences can also be used to help screen areas. Exterior storage areas and trash enclosures shall be planned in such a manner to minimize the exposure of such elements. Parking areas shall be planned in such a manner to allow for landscaping or low, decorative walls or a combination thereof. Where possible, separate service and delivery circulation from parking areas.

Building Plotting Concepts

Buildings should be oriented to take best advantage of arterial visibility. At least one vertical landmark element within each commercial development should be used. When planning the interior vehicular circulation and parking, a hierarchy should be developed to help with traffic flow. Building masses should be articulated to avoid long straight building façades and create enclosed courtyards and pedestrian spaces where possible. Vertical mass at residential edges should be minimized. Where commercial areas are adjacent to water, buildings and courtyards should be oriented to maximize visual and physical access to water.

Vehicular Circulation/Parking

Project entry areas provide visitors with an overview of the project. It should provide an open window orienting to a focal element of the complex. Positive public image features, i.e. water fountains or sculptural art, or dramatic landscape elements, i.e. tree masses, are strongly encouraged to enrich the character of the commercial development. Textured paving is encouraged, especially at entries. The project should provide adequate landscaping to soften the impact of vast paved areas and to provide shade and should also orient parking aisles perpendicular to complexes to allow for easy pedestrian access to shopping. Low freestanding walls incorporating simple, tasteful signage with pilasters, balustrades, finials and other embellishments are desirable.

Pedestrian Circulation

Design should provide generous space for pedestrian activity. The use of water elements and shade are encouraged. Emphasis of texture, color and landscaping is essential.

Common Space Elements

Site furnishings and details which enrich the commercial development are strongly encouraged as well as low walls, balustrades and columns with finials. Seating areas with umbrellas and benches add vibrancy to any commercial establishment. The use of

pottery, tree grates, detailed lighting fixtures, and wrought iron embellishments are encouraged. Accent colored canopies and unique business identification signs are desirable.

- Prominent and/or unique architectural elements should be positioned as the focal points in the development.
- One and two-story building massing should occur. False second-story elements may be incorporated to provide for variation in building massing and reinforce the enclosure of public spaces and plazas.
- Consideration should be given to locating the second floor façade behind the setback from the first floor façade to provide relief in the building plane and provide for outdoor covered walkways, balconies etc.
- Architectural features should extend above the second floor rooflines.
- Accent materials such as stone and brick, accent colors, door and window details, and other architectural enhancements should occur along the first floor/pedestrian level along all publicly visible façades.
- Retail/commercial buildings fronting major public streets must have a high level of architectural detail and enhancement. Rear façades facing onto parking lots should be enhanced to address the retail use/shop use within. Rear entrances to shops and pedestrian paseos passing through buildings from the rear parking lots should be architecturally enhanced, easily visible and inviting.
- Storefront signage is required along rear façades facing onto parking lots and/or public spaces (as well as front façades facing streets and plazas).
- Substantial variations in massing should include changes in height and horizontal plane.
- Horizontal masses should not exceed a width: height ratio of 3:1 (i.e. should not be longer and flatter) without a substantial vertical architecture element that either projects up or away from the building, such as a tower, bay, lattice, or other architectural feature.
- Pedestrian friendly spaces and scale shall be incorporated.
- Building forms that vest and define visually interesting interior and exterior spaces shall be created where appropriate.
- Different heights may be used to communicate different uses or shops.
- Bay windows and stepped buildings also create added visual interest and relate directly to the pedestrian environment.
- Covered trellises, or shaded arcades, pergolas, porticos or overhanging eaves are encouraged in order to connect varied masses and create a more comfortable experience along pedestrian routes.
- Major building entries should be emphasized with special massing and/or architectural treatment.
- Higher tower elements or similar features are encouraged at focal points, such as plazas, major entrances, or where walkways meet streets.
- Large flat wall planes and the use of repetitive elements shall be avoided.
- A range of roof forms and pitches shall be used to add visual interest to the community streetscape.
- A mix of one- and two-story components shall be used along with the use of focal vertical elements where possible.

- The use of natural materials (stone, slate, etc.) shall be used to provide texture and scale to wall surfaces.
- All roofing materials shall be of a fire retardant material, including treated shingles and shall be non-reflective (unglazed).
- Material changes should not occur at external corners, but may occur at “reverse” or interior corners or as a “return” at least two feet from external corners.
- Glass curtain wall construction and reflective glass are discouraged.
- Building façades should not be monotonous or have a flat, shadowless appearance on any façade highly visible from a street or main gathering area.
- Buildings should be clustered to optimize open space and create areas for gathering places; highlight landscape amenities; and create effective pedestrian connections.
- Structures, landscape and hardscape should be designed to create views into the commercial center establishing a sense of arrival.
- Freestanding buildings should be located close to the street to create an attractive and pedestrian friendly environment.
- Primary pedestrian entries should be clearly expressed or recessed by a sheltering element such as an awning, arcade, porch, pergola or portico.
- Special architectural features, such as bay windows, decorative roofs and miscellaneous entry features may project up to three feet into front setbacks and public right-of-ways, provided that they are not less than eight feet above the sidewalk.
- No wall should have a blank, uninterrupted length exceeding thirty feet without including one of the following: change in texture, change in plane, window (excluding clerestory windows and glass block), lattice, tree or equivalent element.
- Façades that are visible from adjacent streets or walkways should display even greater visual interest by using architectural elements that break up the massing of large buildings, such as windows, arcades, porticos, pergolas, and other architectural features.
- Façades should have a recognizable “base” defined (but not limited to) one or more features such as: cornice treatments, roof overhangs with brackets, stepped parapets, richly textured materials, and/or differently colored materials
- Commercial Monumentation is a key element to drawing in and appropriately guiding the consumer. Examples of this can be found in Figure 4-24 *Commercial Monumentation – Option 1* and Figure 4-25 *Commercial Monumentation – Option 2*.



Commercial Entry Monumentation

Two curved stone walls wrap around the entry. The front wall is 20 feet high sloping on one side into a bed of native shrubs and flowers. This wall holds the Oak Valley Symbol and placard alongside of the commercial signage. The back wall provides depth and added interest nested behind the signage wall. The bouganvillea vine provides a strong accent to lead your eye into the shopping plaza. The equestrian fencing strengthens the theme of the community and provides a barrier from the shopping plaza and the street. Both walls will have lighting to accent the depth and texture of the wall. A low and subtle drought resistant plant palette will be used in and around the stone walls. These immediate medians consist of decorative stone paving; others are landscaped medians.



SUMMERWIND RANCH AT OAK VALLEY

Specific Plan Area No. 1,
Amendment No. 1



Commercial Monument - Option 1

FIGURE IV-24

PAGE IV-56



Commercial Entry Monumentation

A stone wall grows from the ground, wrapping around a 20' tall pilaster. The pilaster holds the community logo and town center sign. Commercial signage is protruding from the monument, suspended from wood or woodcrete beams embedded into the pilaster. The rear wall sits behind the pilaster, adding depth and grandeur to the monument. Drought tolerant, low maintenance vegetation is planted throughout the monument, laced with inconspicuous accent lighting. These immediate medians consist of decorative paving; others are landscaped medians.



SUMMERWIND RANCH AT OAK VALLEY

Specific Plan Area No. 1,
Amendment No. 1



FIGURE IV-25

Commercial Monument - Option 2

D. Community Elements

1. Community Design Theme

The community design concept focuses on preserving and enhancing the existing natural character of the site. Simplicity will be the primary focus of the landscape plan, utilizing a plant palette that respects and enhances the existing native plant communities through the use of native and appropriate non-native drought tolerant species. Complementing the landscape theme, and hardscape elements within the community, such as entry monumentation, signage, walls and fences, will evoke the same respect for the natural environment, utilizing stone, wood and natural materials characteristic of the SUMMERWIND RANCH AT OAK VALLEY project site as its foundation whenever possible. Community entries and all other entries consist of a thematic blend of construction features, landscape features, signage and specialty lighting that provides strong landmarks and reinforces the distinctiveness of SUMMERWIND RANCH AT OAK VALLEY.

The architecture of the individual homes will have a timeless quality that is historically familiar and climatically appropriate. It will embrace a subtle blend of traditional styles that have been demonstrated over the last hundred years. Ideally, natural and man-made elements will be seen to be in balance and the colors will complement or match the natural colors of the native rock, soil and landscape of SUMMERWIND RANCH AT OAK VALLEY.

2. Community Entry Monumentation

Entries and key intersections within SUMMERWIND RANCH AT OAK VALLEY reinforce a community hierarchy established by the various circulation patterns and amenities within the community. These features are created through a thematic blend of hardscape and landscape elements by providing strong landmarks and a sense of place and orientation within the community. A comprehensive and coordinated treatment for landscape, hardscape and monumentation creates a strong thematic identity for the project which also enhances the community's function and aesthetic quality. Figure 4-26, *Key to Monumentation, Streetscapes & Edge Conditions*, depicts the location of entry monuments, streetscapes and edge conditions within the SUMMERWIND RANCH AT OAK VALLEY project site.

The design theme for the entries in this development is in line with the natural and rural themes of the project. Entries are each unique, but all share the same relative scale and mass to provide a constant element in their design. All incorporate materials such as rough stones with engraved community signs and battered stone pilasters. The somewhat uniform choice of materials for the entries will also provide a sense of design continuity. The signage in the community is intended to meet functional needs such as informational, way finding, and identification while also supplementing architectural, landscape, and urban design features in establishing a cohesive and textured project design theme. The signage program will establish consistency and diversity.

Edge Condition Legend:

Symbol	Description
	Residential / I-10 Freeway
	Commercial / I-10 Freeway
	Residential / Commercial
	Residential / Open Space
	Residential / Riparian Corridor
	Residential / Linear Park
	Residential / Active Park
	Residential / Recreation Center
	Park / Open Space
	Active Park / School

Monumentation Legend:

Symbol	Description
	Special Landscape Treatment
	Commercial/Business Monument
	Major Community Monument
	Minor Community Monument
	Neighborhood Monument
	School Monument
	Park / Rec. Center Monument

Note:
For trail monument locations refer to the Trail Master Plan.

Street Tree Legend:

Symbol	Description
	Interstate Highway
	Urban Arterial Highway - Landscaped median - Canopy parkway trees
	Arterial Highway - Landscaped median - Canopy & ornamental parkway trees
	Major Highway - Landscaped Median - Ornamental parkway trees
	Secondary Road - Landscaped Median - Ornamental parkway trees
	Secondary Road - Landscaped Median - Ornamental parkway trees
	Divided Collector Road - Ornamental parkway trees

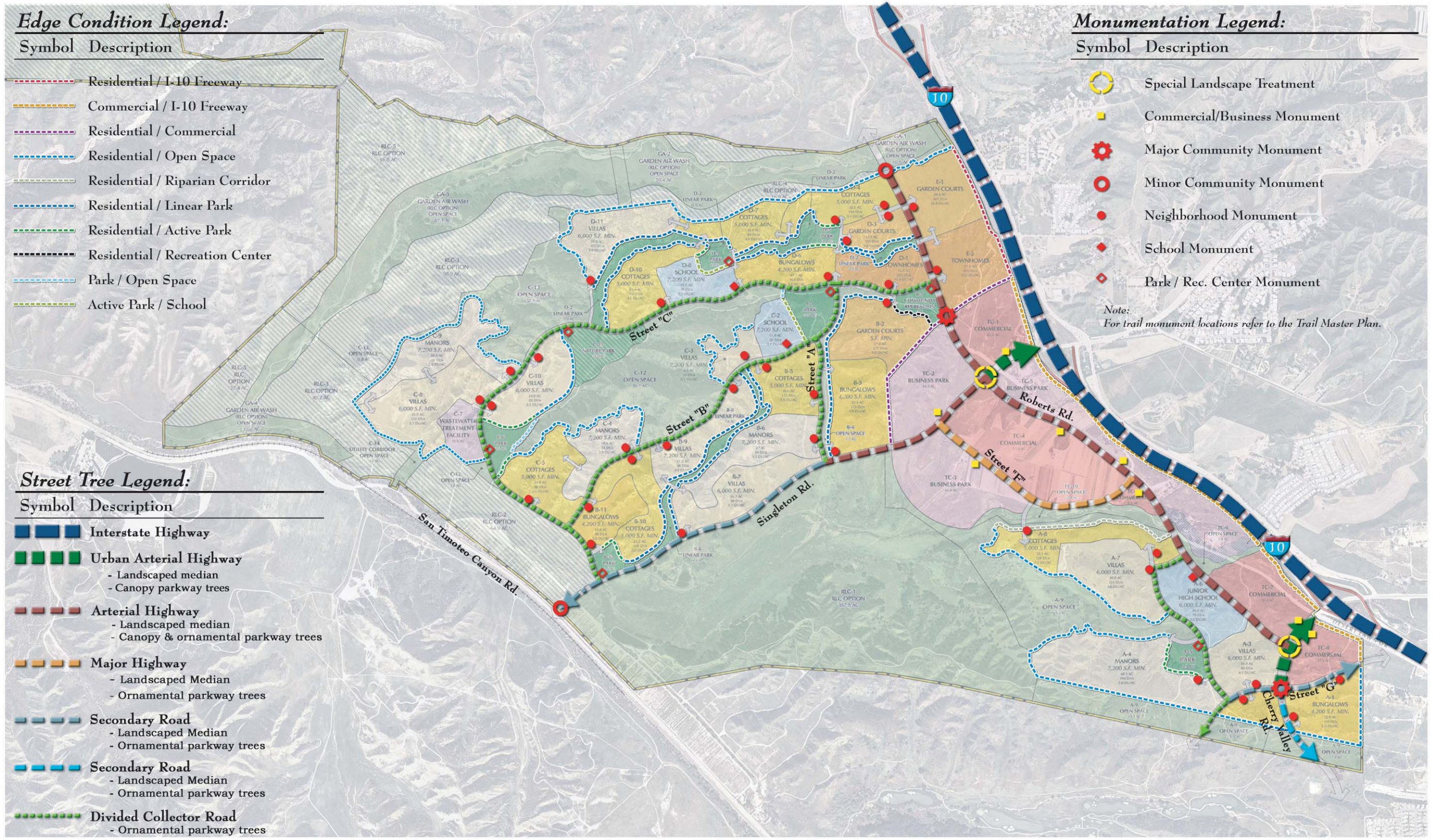

SUMMERWIND RANCH AT OAK VALLEY

Specific Plan Area No. 1,
Amendment No. 1



FIGURE IV-26
Key to Monumentation, Streetscapes & Edge Conditions

- ❑ **Major Community Entry Monumentation**

Major Community Entry Monumentation identifies initial entry into the residential portion of the project site and leads away from the Town Center village of SUMMERWIND RANCH AT OAK VALLEY. Figure 4-27, *Major Community Entry Monumentation* shows this concept.
- ❑ **Minor Community Entry Monumentation**

Minor Community Entry Monumentation identifies initial entry into the project site in areas from secondary or less traveled roads. Figure 4-28, *Minor Community Entry Monumentation* shows this concept.
- ❑ **Neighborhood Entry Monumentation**

Neighborhood Entry Monumentation identifies entrances into individual planning area neighborhoods. Though smaller in scale, the neighborhood entries reflect the same character and materials utilized in the other entries. Flexibility and individuality is allowed to foster neighborhood identity within the project site, provided the stone materials, signage letter style and planting remain consistent throughout the project. Examples of options for this are shown on Figure 4-29, *Neighborhood Entry Monumentation – Option 1* and Figure 4-30, *Neighborhood Entry Monumentation – Option 2*.
- ❑ **Special Feature Monumentation**

As shown in Figure 4-31, *Special Feature Monumentation* are monuments which are located as Town Center landmarks. They are located only within the Town Center, at the two major intersections. They will be consistent in design with other monumentation found throughout the project site so as to be recognizable in theme and meaning.
- ❑ **School Monumentation**

As shown in Figure 4-32, *School Monumentation* will include elements such as a marquee, school identification, battered stone pilasters with or without caps, curved stone walls with a cap, and the 2-rail theme fence. School monumentation will be consistent with the community's design theme and similar in appearance for the various school sites.
- ❑ **Park Monumentation**

As shown in Figure 4-33, *Park Monumentation* will include elements such as a designated monument area, a walkway, a stone pilaster with cap, the SUMMERWIND RANCH AT OAK VALLEY Logo and Placard, "Broken" wall, park signage, and battered stone pilasters.

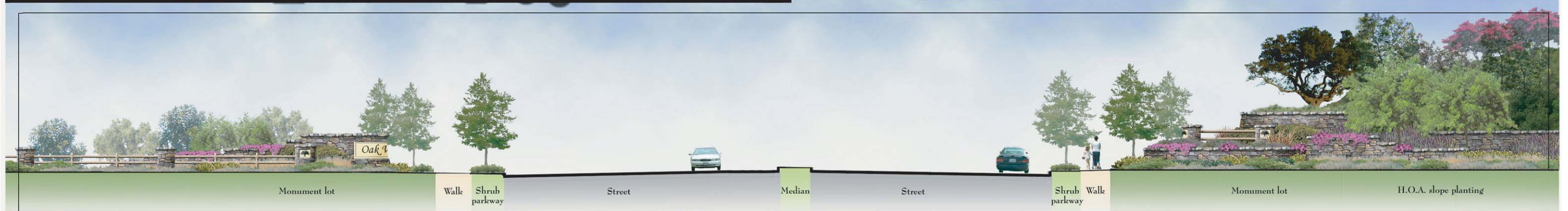
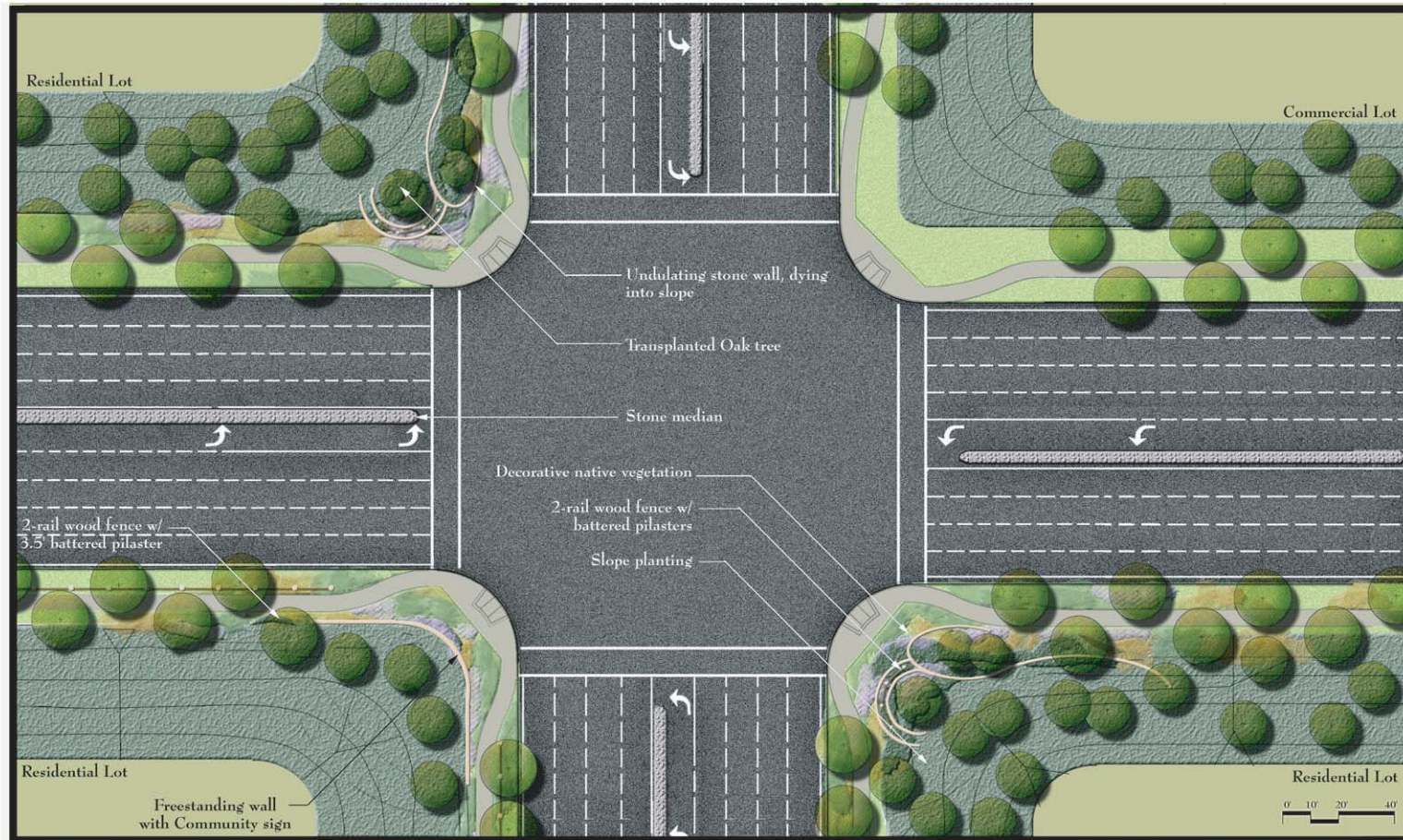

SUMMERWIND RANCH AT OAK VALLEY

Specific Plan Area No. 1,
Amendment No. 1



FIGURE IV-27

Major Community Entry Monumentation

PAGE IV-61

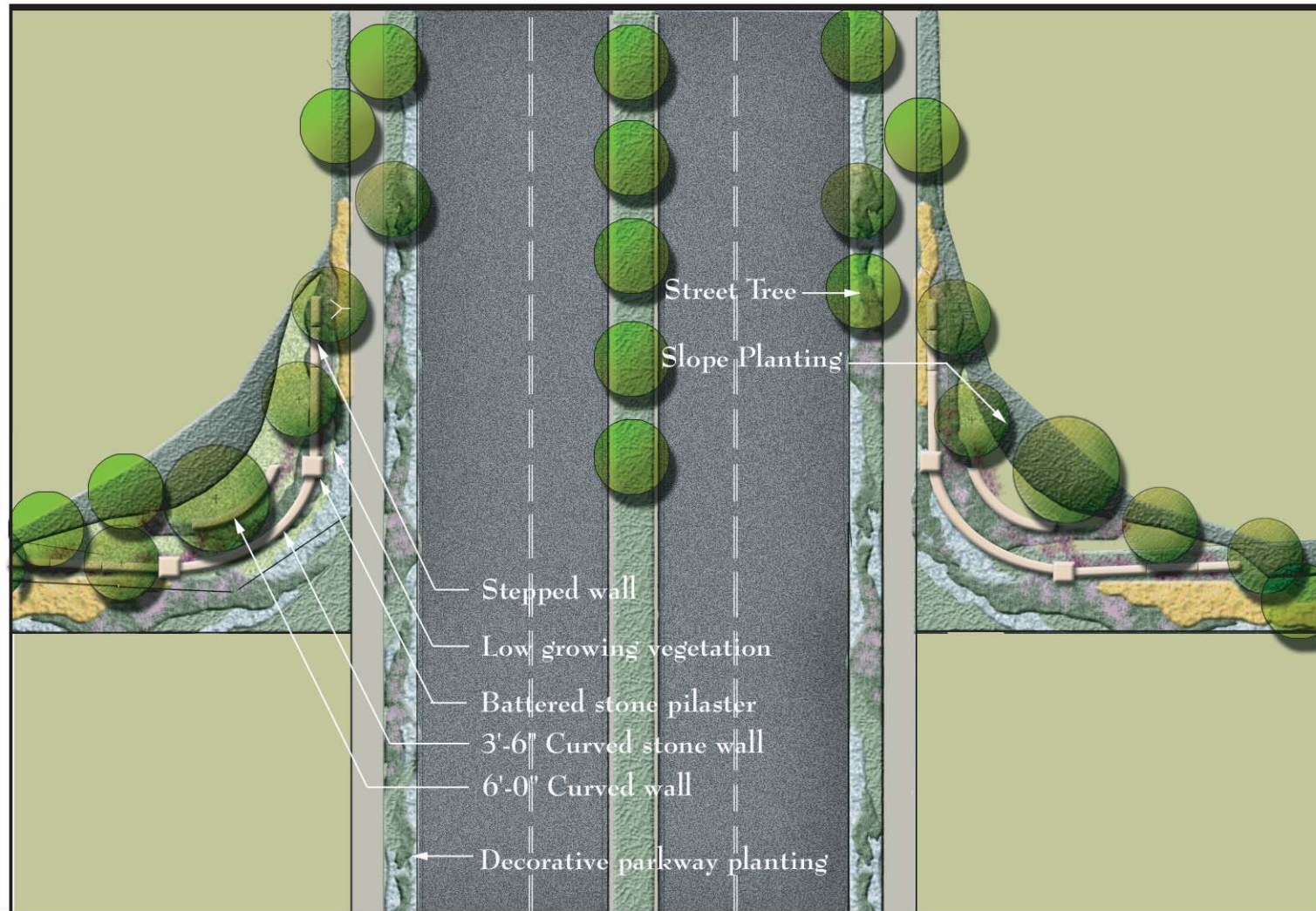

SUMMERWIND RANCH AT OAK VALLEY

Specific Plan Area No. 1,
Amendment No. 1



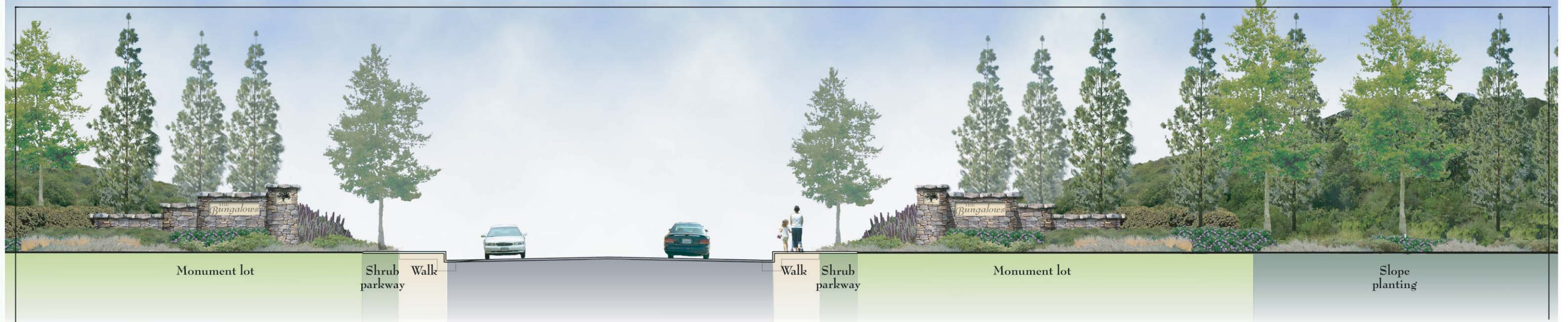
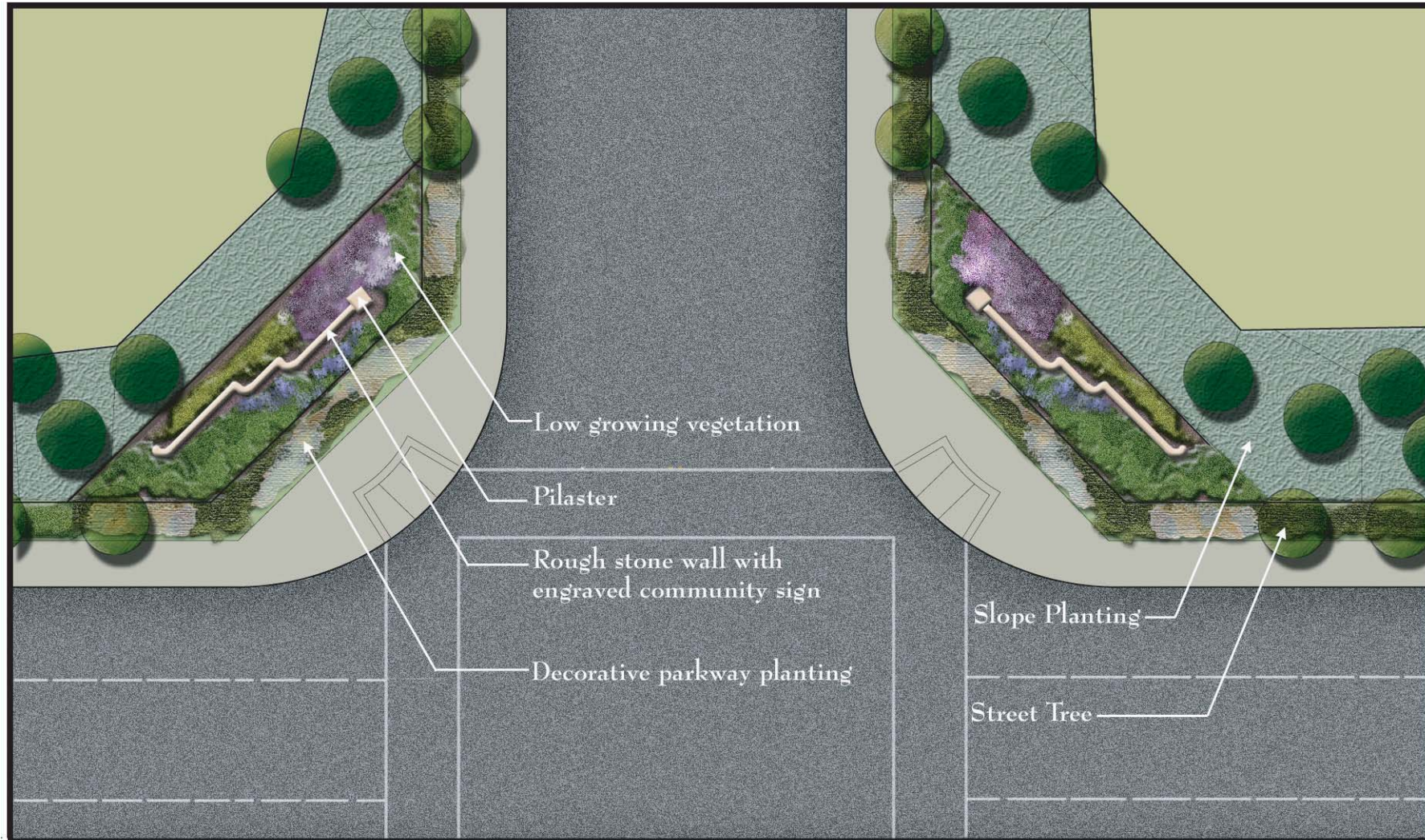

SUMMERWIND RANCH AT OAK VALLEY

Specific Plan Area No. 1,
Amendment No. 1



Neighborhood Entry Monumentation - Option 1

FIGURE IV-29

PAGE IV-63

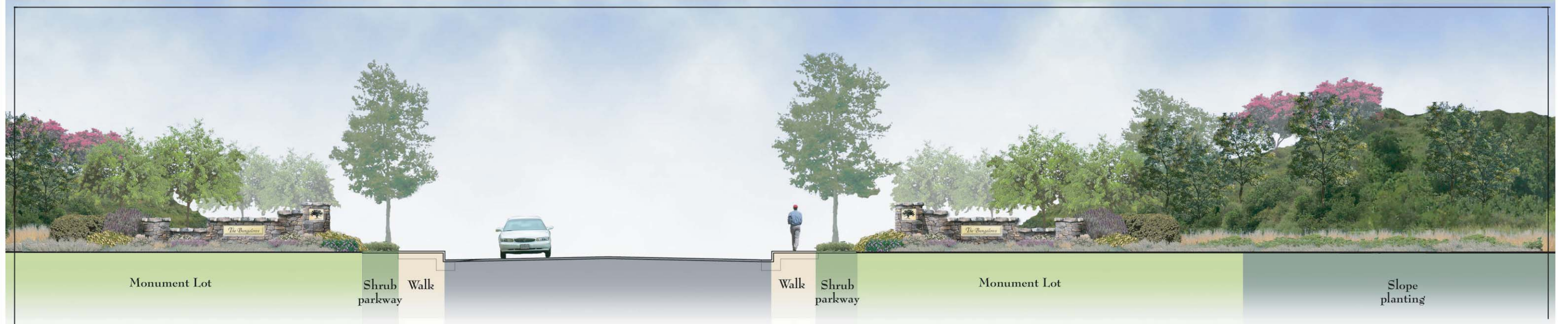
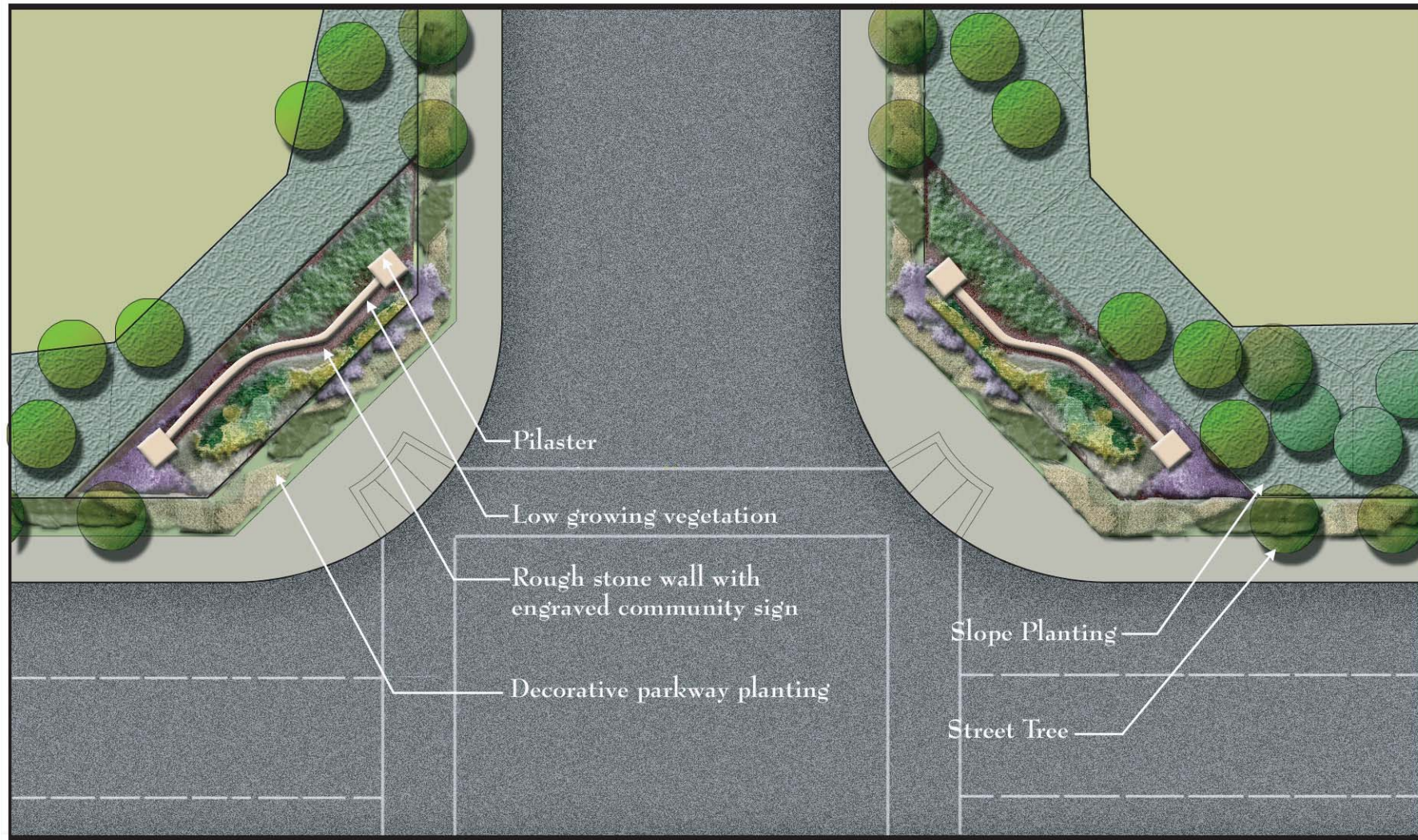

SUMMERWIND RANCH AT OAK VALLEY

Specific Plan Area No. 1,
Amendment No. 1



FIGURE IV-30
Neighborhood Entry Monumentation - Option 2

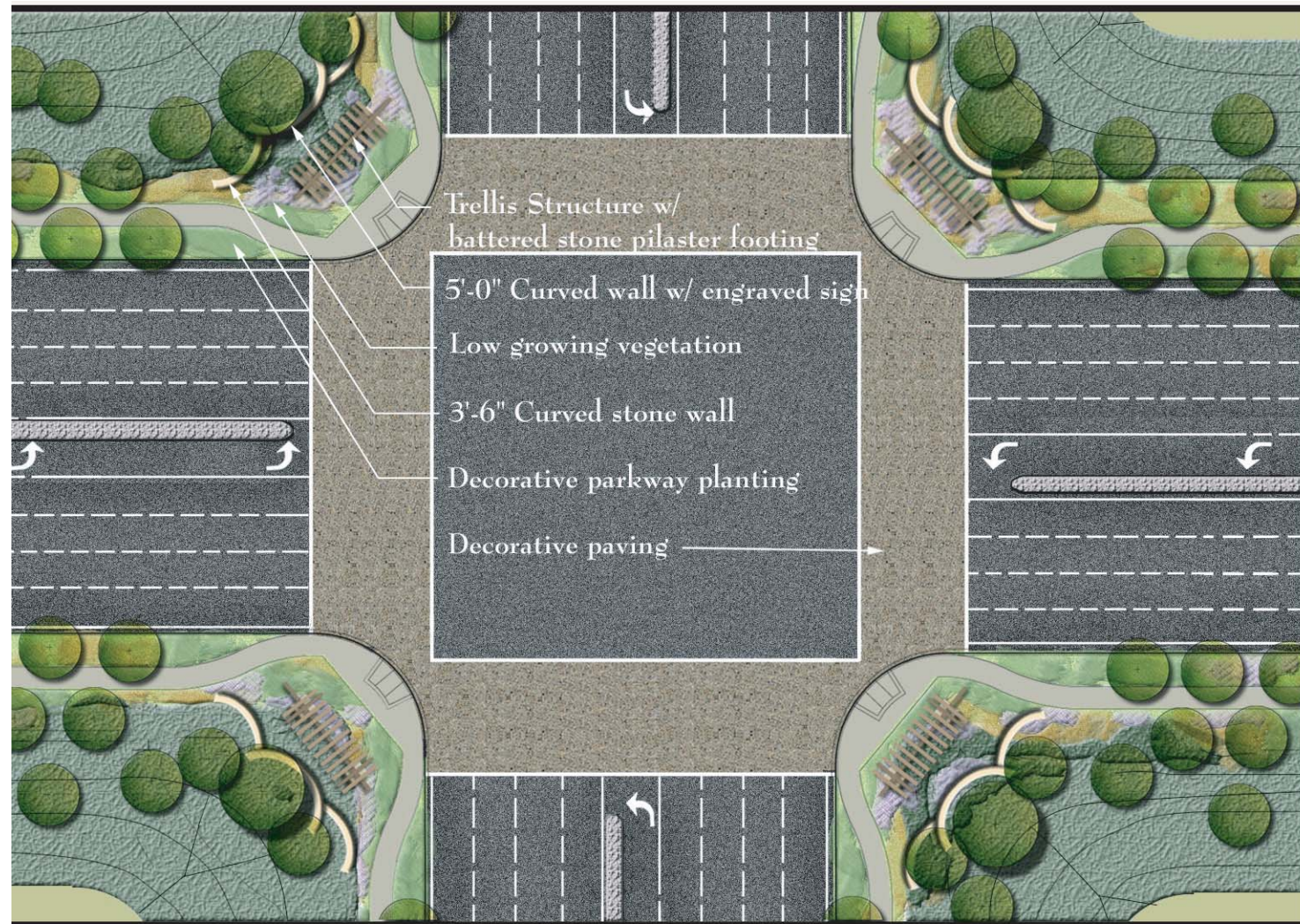

SUMMERWIND RANCH AT OAK VALLEY

Specific Plan Area No. 1,
Amendment No. 1



FIGURE IV-31

Special Feature Monumentation

PAGE IV-65

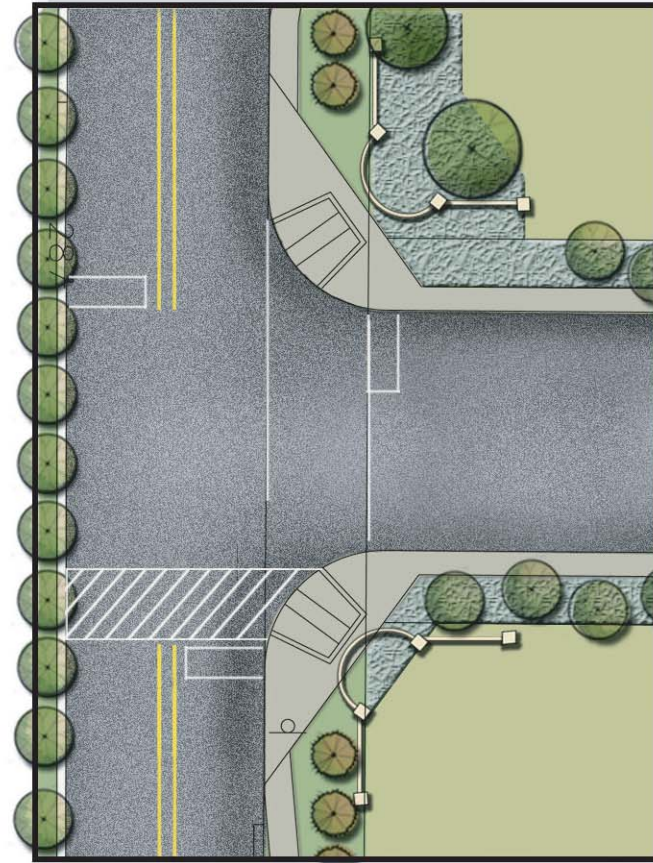

Option One



Option Two

SUMMERWIND RANCH AT OAK VALLEY

Specific Plan Area No. 1,
Amendment No. 1



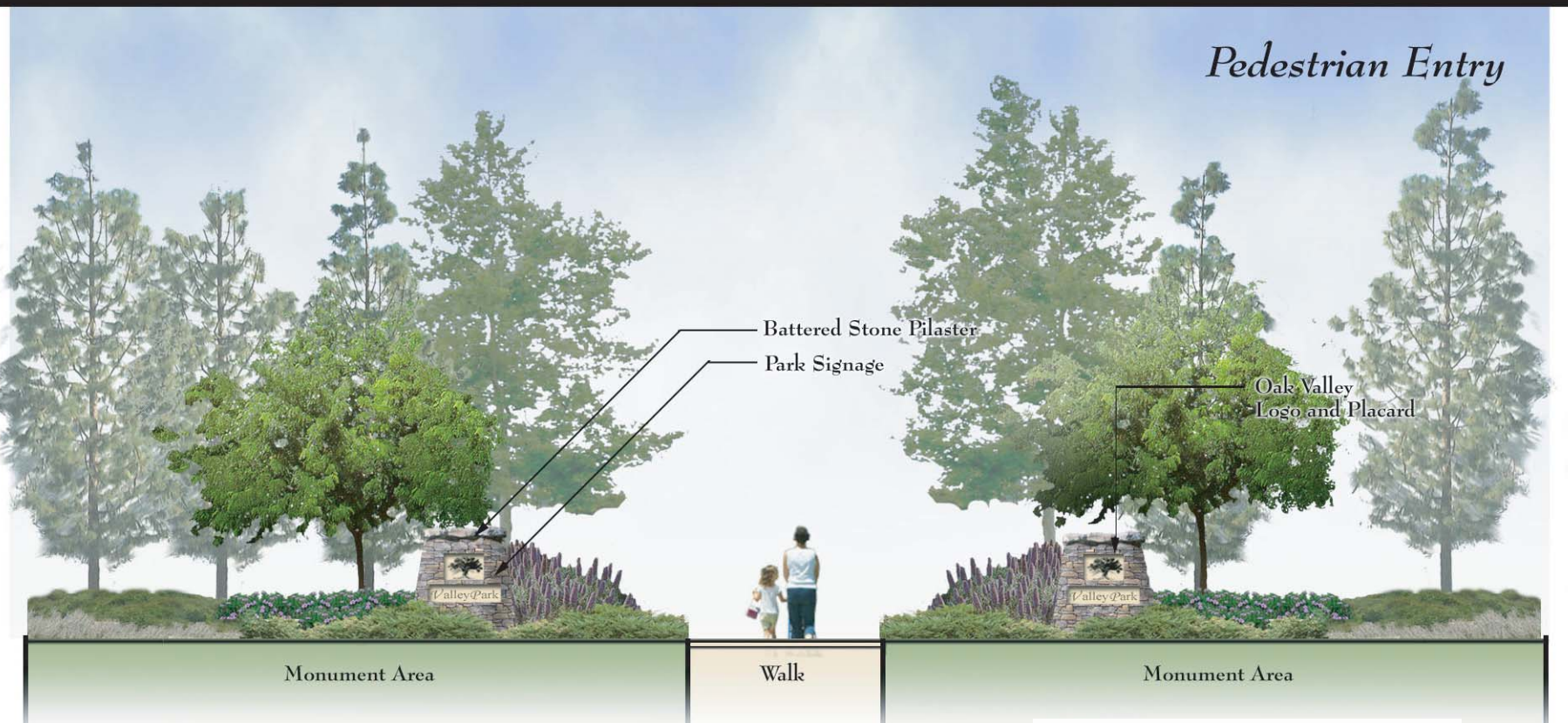
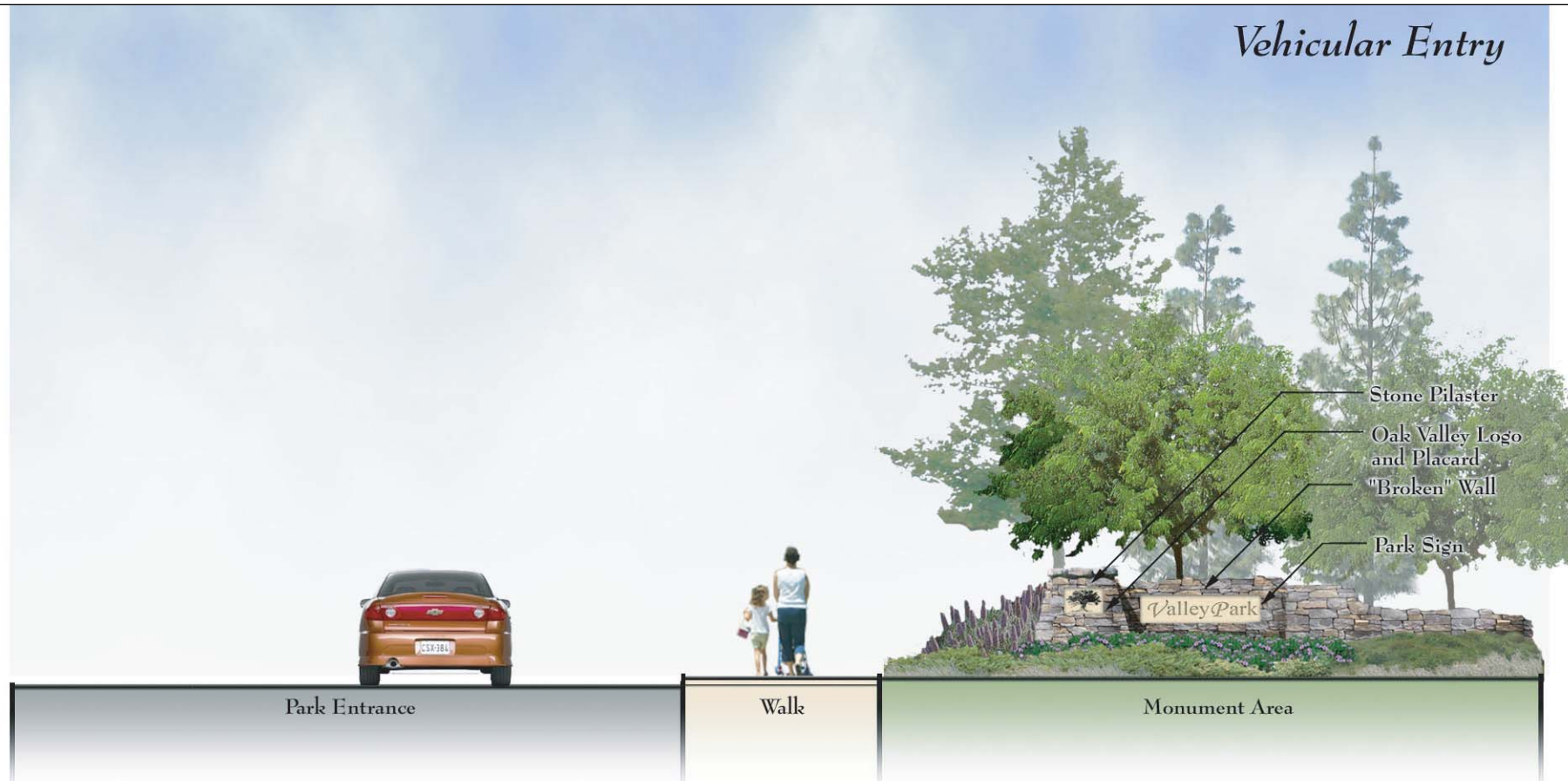
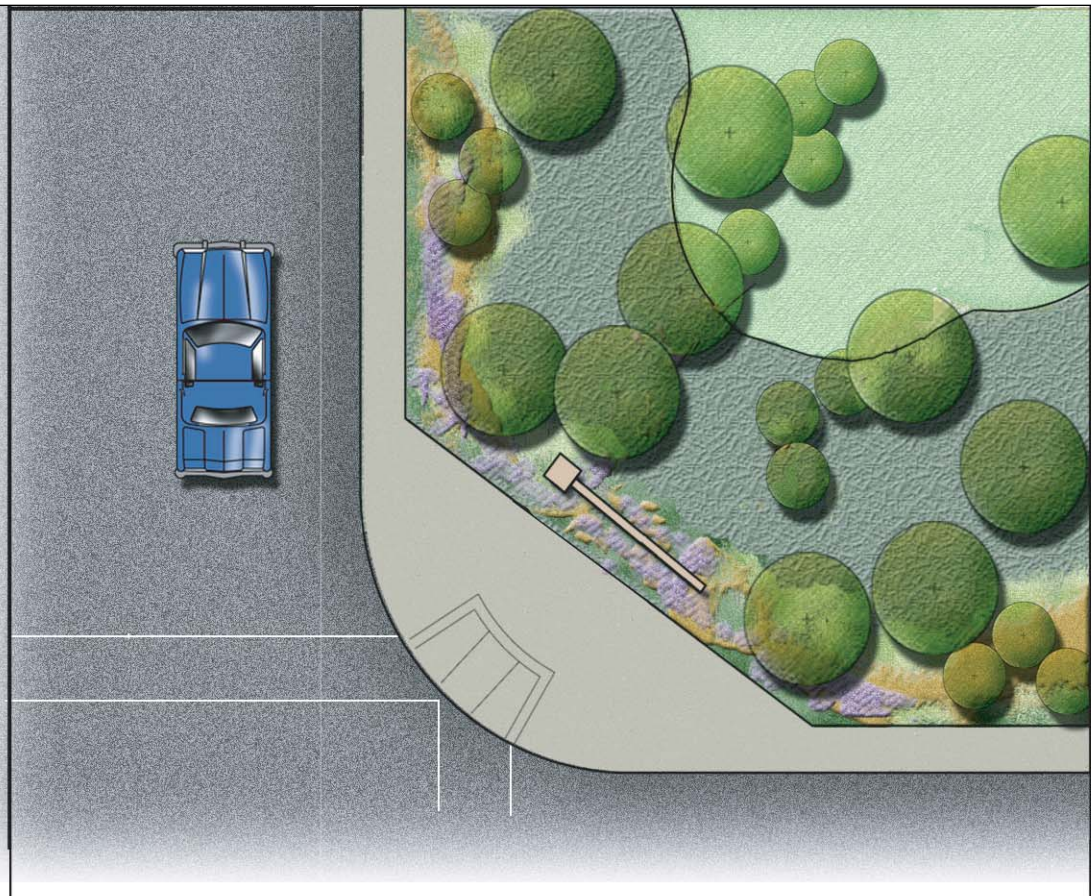

SUMMERWIND RANCH AT OAK VALLEY

Specific Plan Area No. 1,
Amendment No. 1



3. Trail Monumentation

As shown in Figure 4-34 *Trail Monumentation* will include various elements from the options presented. These elements include battered stone wall with stone cap, high-pressure laminate plaque with trail information including: trail map, elevation diagram, and point of location, double stone pilasters with stone cap and engraved community plaque, and wood, concrete, or stone markers.

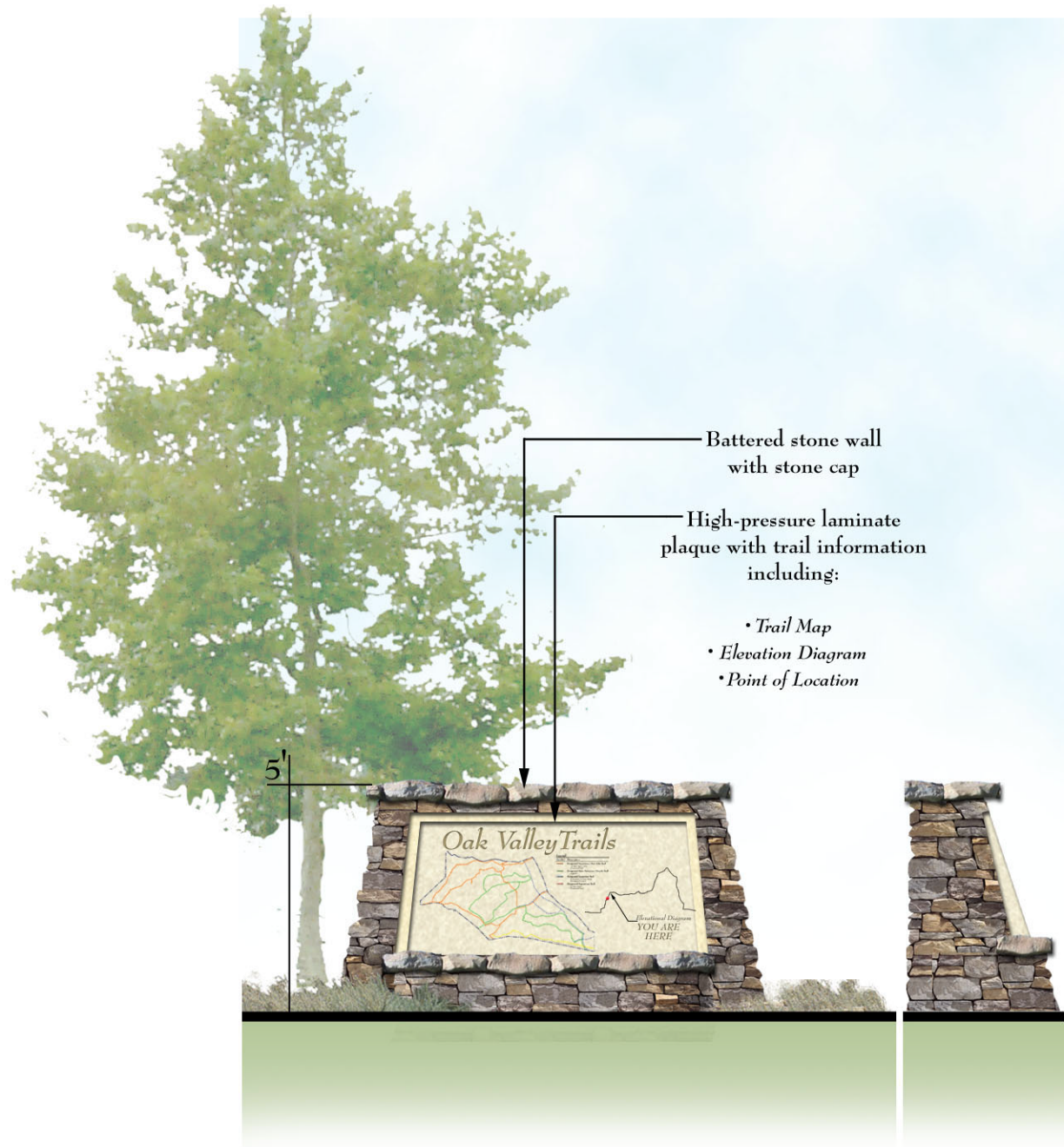

Trail Head Monuments □

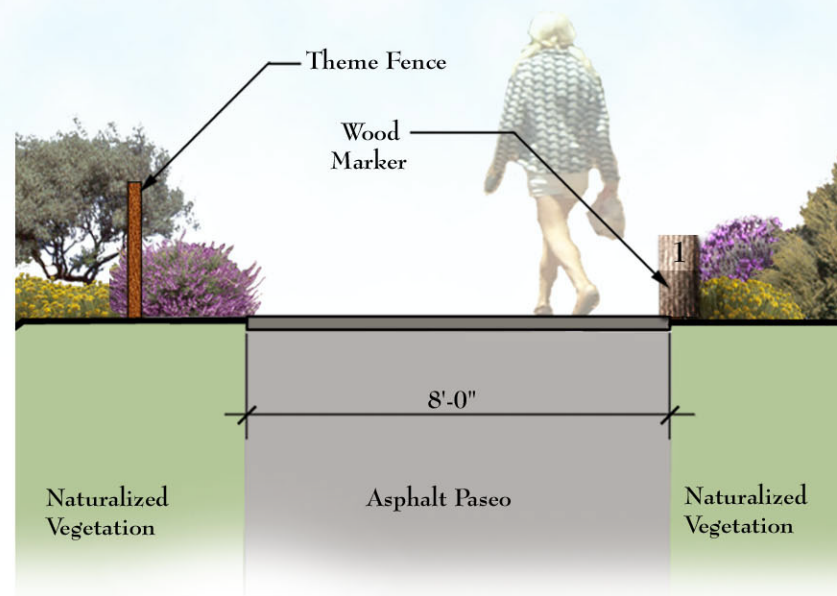

Distance Markers Along Paseo

- Use native vegetation in open space.
- Use drought resistant vegetation in linear park areas.

E. Street Landscaping

1. Streetscapes

Streetscape landscaping within SUMMERWIND RANCH AT OAK VALLEY will respond to the surrounding natural environment in which it occurs. The roads form a hierarchy in their layout. Their landscape character and setbacks reinforce hierarchy, with greater setbacks and landscaped medians on larger roads and slightly narrower setbacks on smaller roads, such as collector roads.

- ❑ **Singleton Road Streetscape**
The segments for Singleton Road Streetscape are shown in Figure 4-35 *Singleton Road Streetscape – Secondary Highway Portion* and Figure 4-36 *Singleton Road Streetscape – Arterial Highway Portion*.
- ❑ **Roberts Road Streetscape**
Roberts Road Streetscape is shown in Figure 4-37 *Roberts Road Streetscape*. This road has a 110' right of way with sidewalks, parkways, and a median.
- ❑ **Major Road Streetscape**
The Major Road Streetscape describes what is typical for major roads in the project. These are 100' right of way roads with sidewalks, parkways, and a median. This is shown in Figure 4-38 *Major Road Streetscape*.
- ❑ **Divided Collector Road Streetscape**
The Divided Collector Road Streetscape is shown in Figure 4-39 *Divided Collector Road Streetscape*.
- ❑ **Modified Secondary Road Streetscape**
The Modified Secondary Road Streetscape is shown in Figure 4-40 *Modified Secondary Road Streetscape*.
- ❑ **Urban Arterial Highway Streetscape**
The Urban Arterial Highway Streetscape is shown in Figure 4-41 *Urban Arterial Highway Streetscape*.

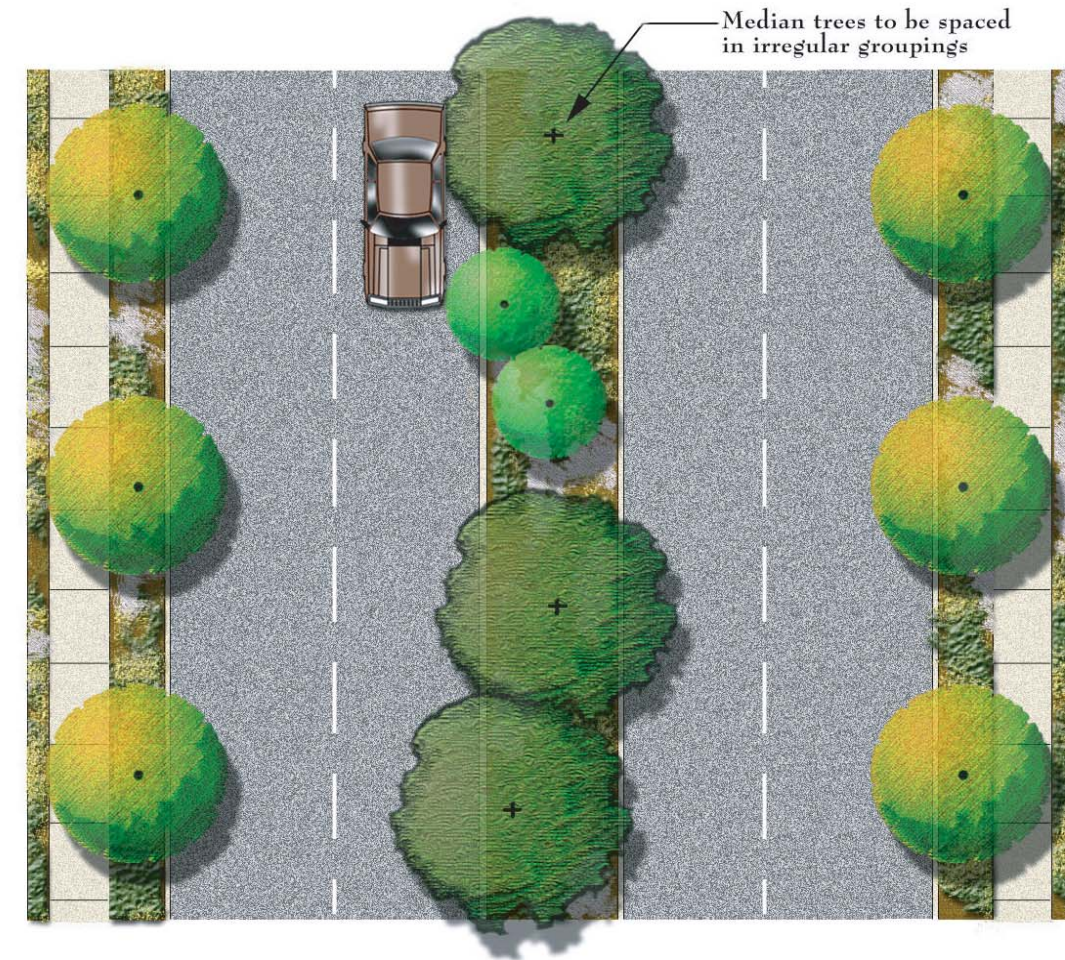
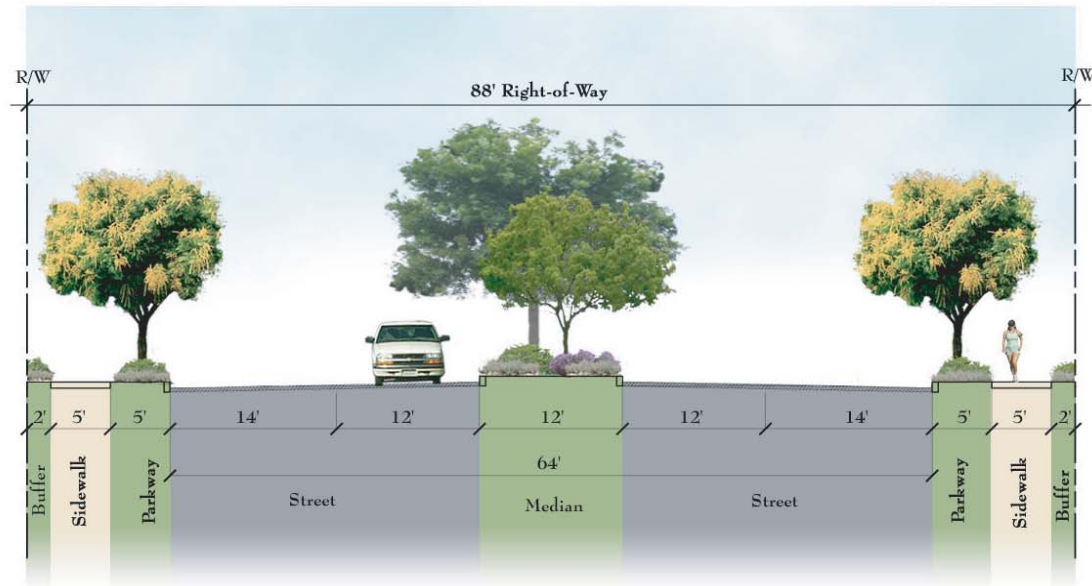

Secondary Highway

Median Trees Such As:

- Cercis occidentalis* - Western Redbud
- Liquidambar styraciflua* - Sweet Gum
- Pinus eldarica* - Eldarica Pine
- Platanus acerfolia* - London Plane Tree
- Podocarpus gracilior* - Fern Pine

Parkway Trees Such As:

- Koelreuteria bipinnata* - Chinese Flame Tree
- Liquidambar styraciflua* - Sweet Gum
- Platanus acerfolia* - London Plane Tree
- Pyrus calleryana 'Bradford'* - Bradford Pear

Shrubs Such As:

- Arctostaphylos* spp. - manzanita
- Baccharis pilularis* - Dwarf Coyote Brush
- Berberis* spp. - Barberry
- Carissa macrocarpa* - Natal Plum
- Ceanothus* spp. - Wild Lilac
- Cistus* spp. - Rockrose
- Encelia farinosa* - Brittle Bush
- Grevillea 'Noellii'*
- Hesperaloe parviflora* - Red Yucca
- Lavandula* spp. - Lavender
- Leucophyllum* spp. - Texas Ranger
- Punica granatum* - Pomegranate
- Rhus ovata* - Sugar Bush
- Salvia greggii* - Autumn Sage
- Salvia leucantha* - Mexican Bush Sage
- Salvia clevelandii* - Cleveland Sage
- Sarcococca hookerana humilis* - Sweetbox

Ground Cover Such As:

- Arctostaphylos 'Emerald Carpet'* - Manzanita
- Arctostaphylos 'Monterey Carpet'* - Manzanita
- Artemisia caucasia* - Silver Spreader
- Baccharis pilularis 'Twin Peaks'* - Coyote Brush
- Ceanothus griseus horizontalis 'Yankee Point'*
- Convolvulus mauritanicus* - Ground Morning Glory
- Juniperus* spp. - Juniper
- Myoporum parvifolium*
- Oenothera berlandieri* - Mexican Primrose
- Rosmarinus officinalis 'Prostratus'* - Dwarf Rosemary
- Santolina chamaecyparissus* - Lavender Cotton
- Santolina virens* - Green Santolina
- Sedum rubrotinctum* - Pork and Beans

Grasses Such As:

- Boutelous gracilis* - Blue Grama Grass
- Carex pausa* - California Meadow Sedge
- Elymus 'Canyon Prince'* - Blue Wild Rye
- Festuca mairei* - Maire's fescue
- Festuca ovina glauca* - Blue Fescue
- Miscanthus transmorrisonensis* - Evergreen Eulalia
- Muhlenbergia pubescens* - Soft Blue Mexican Muhly

* Red text indicates species represented in rendering. Scenes depict plants in summer.

SUMMERWIND RANCH AT OAK VALLEY

Specific Plan Area No. 1,
Amendment No. 1



Singleton Road Streetscape - Secondary Highway Portion

FIGURE IV-35

PAGE IV-71

Arterial Highway (Singleton Road)

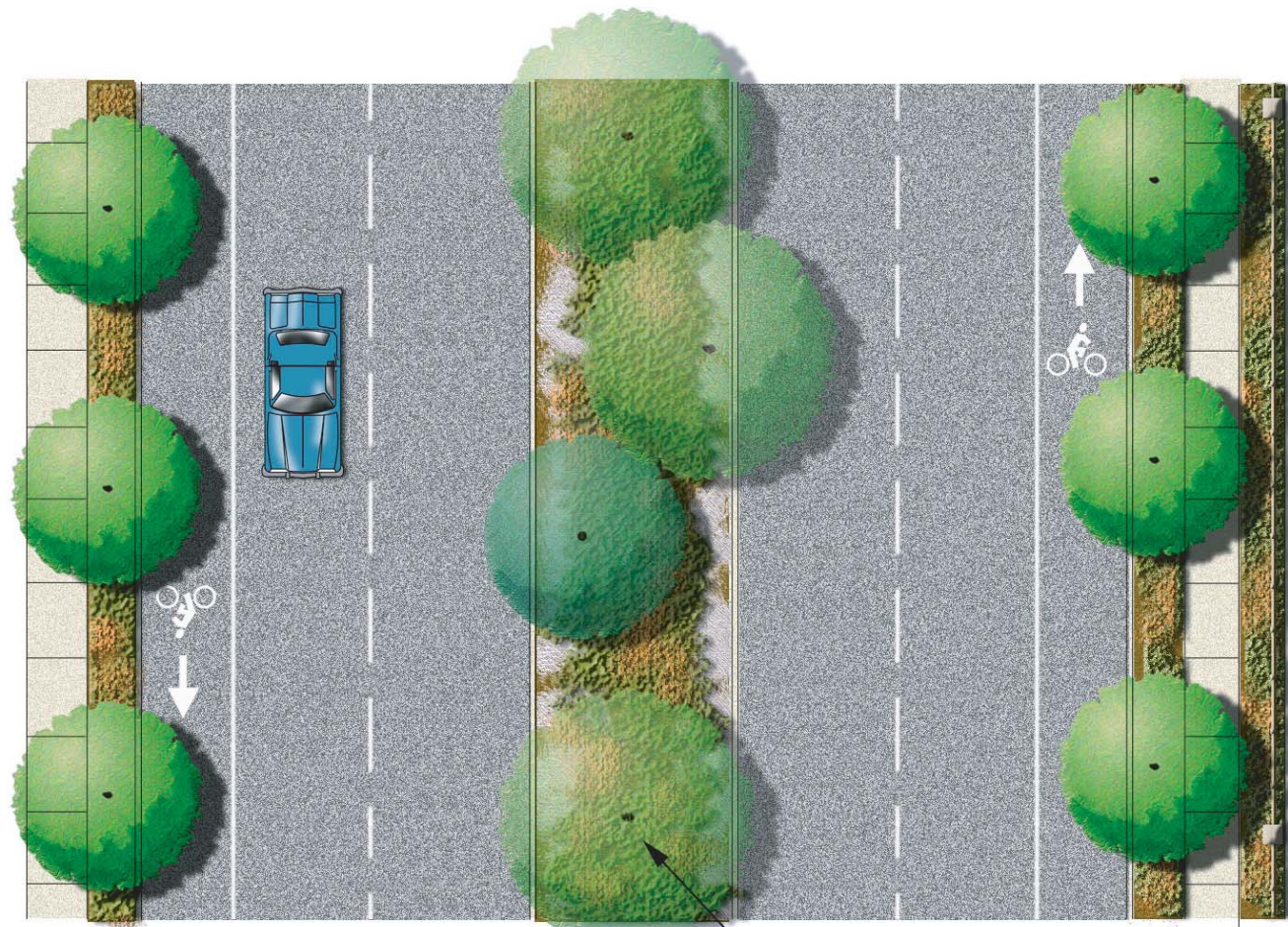
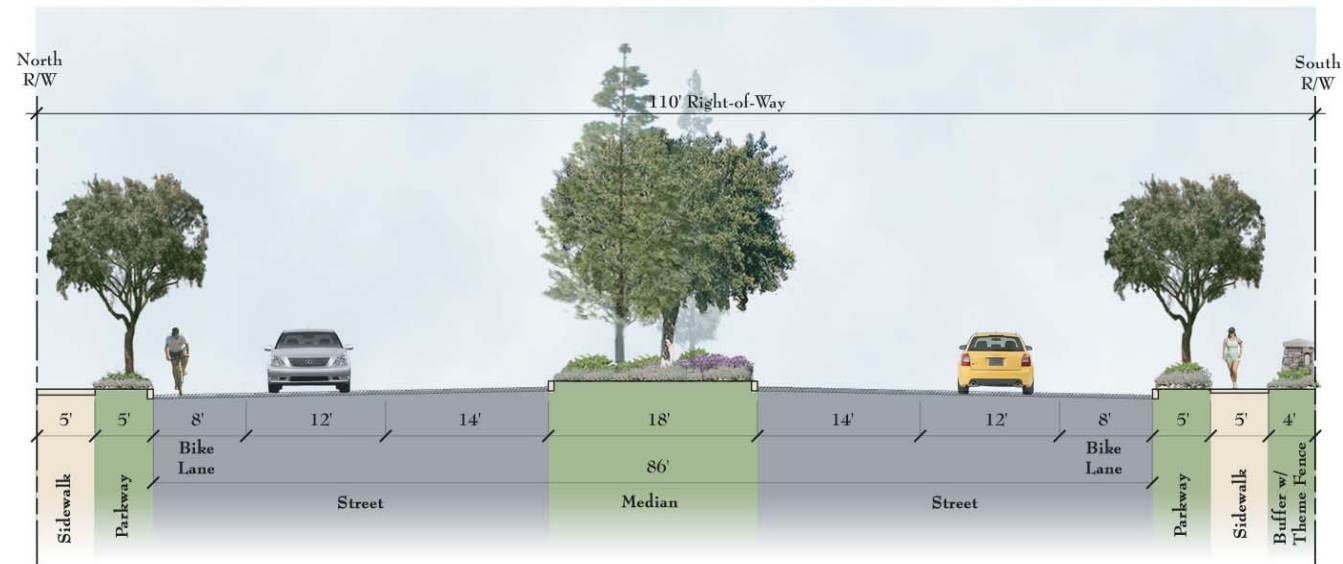

Median trees to be spaced in irregular groupings

- Median Trees Such As:**
 Cinnamomum camphora - Camphor Tree
 Liriodendron tulipifera - Tulip Tree
Pinus canariensis - Canary Island Pine
 Pinus eldarica - Eldarica Pine
Quercus suber - Cork Oak

- Parkway Trees Such As:**
 Chionanthus retusus - Chinese Fringe Tree
 Chitalpa tashkentensis - Chitalpa
 Koelreuteria bipinnata - Chinese Flame Tree
 Platanus acerfolia - London Plane Tree
 Pinus calleryana 'Bradford' - Bradford Pear
Rhus lancea - African Sumac

- Shrubs Such As:**
 Arctostaphylos spp. - manzanita
Baccharis pilularis - Dwarf Coyote Brush
 Berberis spp. - Barberry
 Carissa macrocarpa - Natal Plum
 Ceanothus spp. - Wild Lilac
 Cistus spp. - Rockrose
Encelia farinosa - Brittle Bush
 Grevillea 'Noellii'
 Hesperaloe parviflora - Red Yucca
 Lavandula spp. - Lavender
 Leucophyllum spp. - Texas Ranger
 Punica granatum - Pomegranate
 Rhus ovata - Sugar Bush
 Salvia greggii - Autumn Sage
 Salvia leucantha - Mexican Bush Sage
 Salvia clevelandii - Cleveland Sage
 Sarcococca hookerana humilis - Sweetbox

- Ground Cover Such As:**
 Arctostaphylos 'Emerald Carpet' - Manzanita
 Arctostaphylos 'Monterey Carpet' - Manzanita
 Artemisia caucasia - Silver Spreader
 Baccharis pilularis 'Twin Peaks' - Coyote Brush
 Ceanothus griseus horizontalis 'Yankee Point'
 Convolvulus mauritanicus - Ground Morning Glory
 Juniperus spp. - Juniper
 Myoporum parvifolium
 Oenothera berlandieri - Mexican Primrose
 Rosmarinus officinalis 'Prostratus' - Dwarf Rosemary
 Santolina chamaecyparissus - Lavender Cotton
 Santolina virens - Green Santolina
 Sedum rubrotinctum - Pork and Beans

- Grasses Such As:**
 Boutelous gracilis - Blue Grama Grass
 Carex pausa - California Meadow Sedge
 Elymus 'Canyon Prince' - Blue Wild Rye
 Festuca mairei - Maire's fescue
Festuca ovina glauca - Blue Fescue
 Miscanthus transmorrisonensis - Evergreen Eulalia
 Muhlenbergia pubescens - Soft Blue Mexican Muhly

* Red text indicates species represented in rendering. Scenes depict plants in summer.

Arterial Highway (Roberts Road)

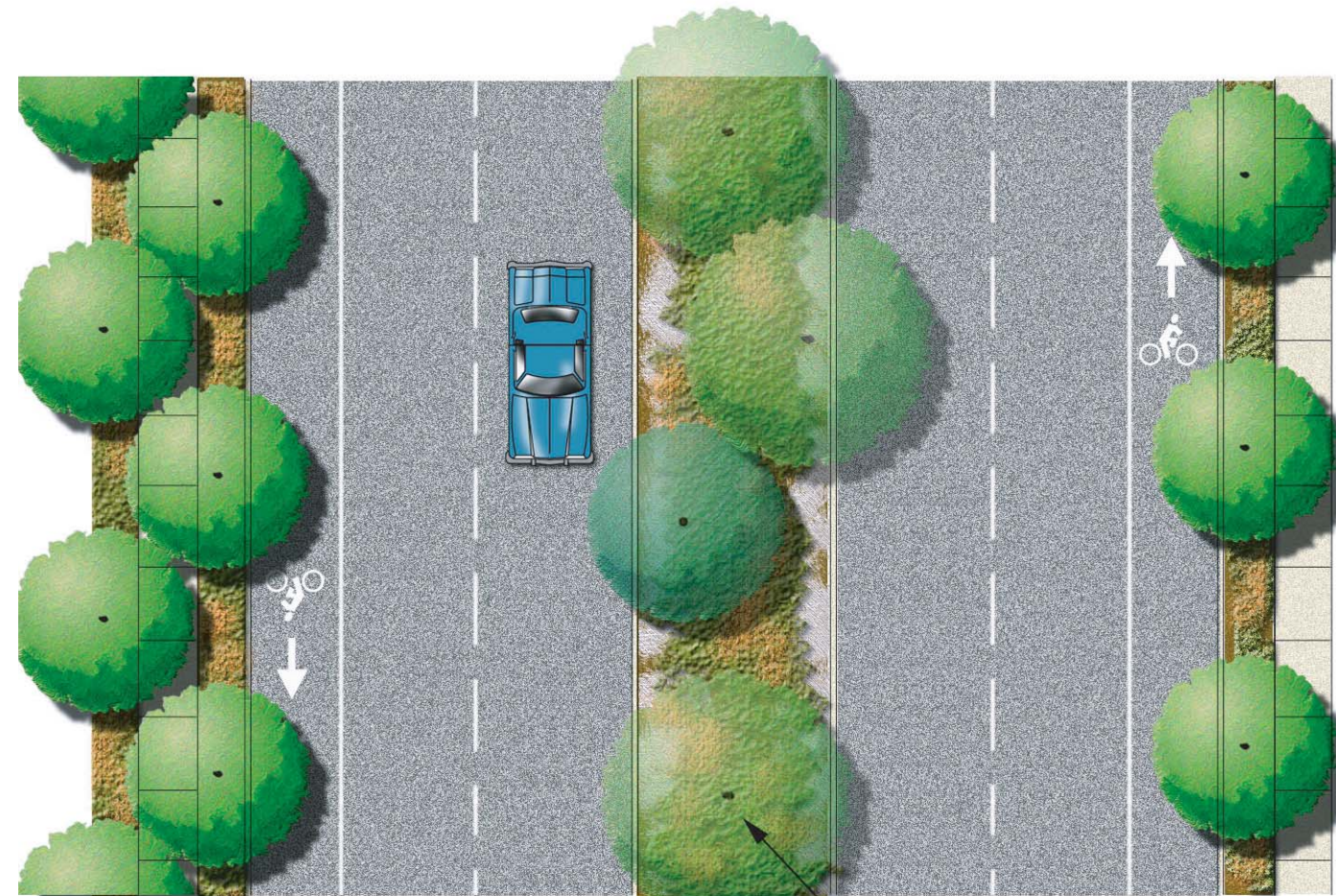
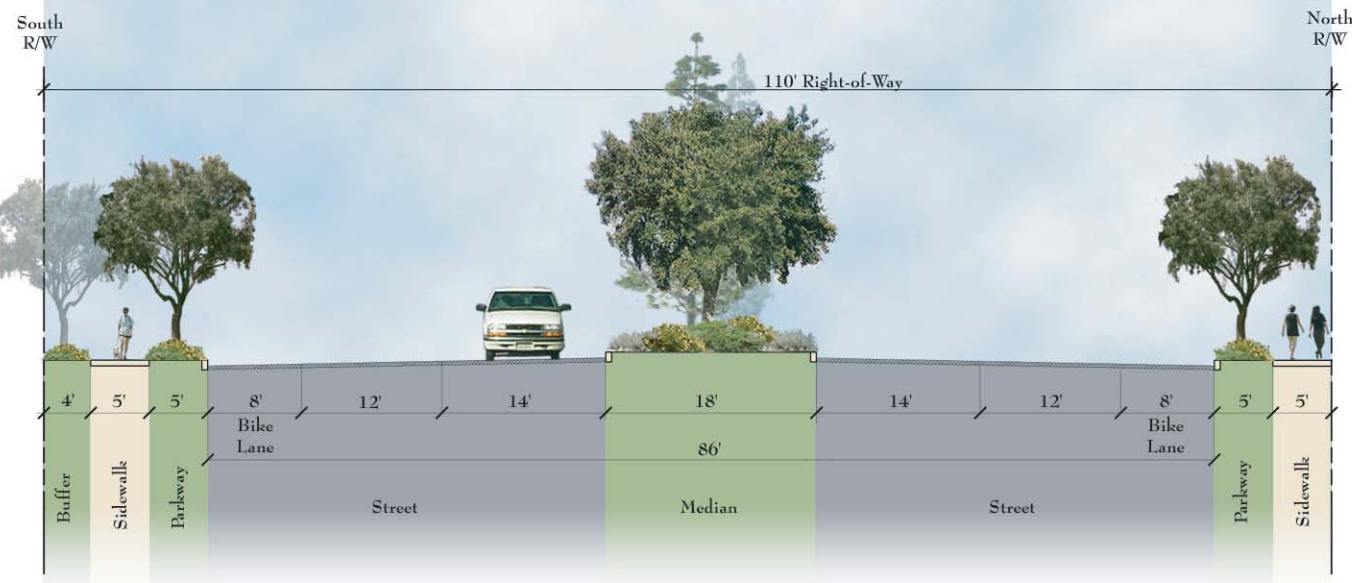

Median trees to be spaced in irregular groupings

Median Trees Such As:

- Cinnamomum camphora - Camphor Tree
- Liriodendron tulipifera - Tulip Tree
- Pinus canariensis - Canary Island Pine**
- Pinus eldarica - Eldarica Pine
- Quercus suber - Cork Oak**

Parkway Trees Such As:

- Chionanthus retusus - Chinese Fringe Tree
- Chitalpa tashkentensis - Chitalpa
- Koelreuteria bipinnata - Chinese Flame Tree
- Platanus acerfolia - London Plane Tree
- Pinus calleryana 'Bradford' - Bradford Pear
- Rhus lancea - African Sumac**

Shrubs Such As:

- Arctostaphylos spp. - manzanita
- Baccharis pilularis - Dwarf Coyote Brush**
- Berberis spp. - Barberry
- Carissa macrocarpa - Natal Plum
- Ceanothus spp. - Wild Lilac
- Cistus spp. - Rockrose
- Encelia farinosa - Brittle Bush**
- Grevillea 'Noellii'
- Hesperaloe parviflora - Red Yucca
- Lavandula spp. - Lavender
- Leucophyllum spp. - Texas Ranger
- Punica granatum - Pomegranate
- Rhus ovata - Sugar Bush
- Salvia greggii - Autumn Sage
- Salvia leucantha - Mexican Bush Sage
- Salvia clevelandii - Cleveland Sage
- Sarcococca hookerana humilis - Sweetbox

Ground Cover Such As:

- Arctostaphylos 'Emerald Carpet' - Manzanita
- Arctostaphylos 'Monterey Carpet' - Manzanita
- Artemisia caucasia - Silver Spreader
- Baccharis pilularis 'Twin Peaks' - Coyote Brush
- Ceanothus griseus horizontalis 'Yankee Point'
- Convolvulus mauritanicus - Ground Morning Glory
- Juniperus spp. - Juniper
- Myoporum parvifolium
- Oenothera berlandieri - Mexican Primrose
- Rosmarinus officinalis 'Prostratus' - Dwarf Rosemary
- Santolina chamaecyparissus - Lavender Cotton
- Santolina virens - Green Santolina
- Sedum rubrotinctum - Pork and Beans

Grasses Such As:

- Boutelous gracilis - Blue Grama Grass
- Carex pausa - California Meadow Sedge
- Elymus 'Canyon Prince' - Blue Wild Rye
- Festuca mairei - Maire's fescue
- Festuca ovina glauca - Blue Fescue**
- Miscanthus transmorrisonensis - Evergreen Eulalia
- Muhlenbergia pubescens - Soft Blue Mexican Muhly

* Red text indicates species represented in rendering. Scenes depict plants in summer.

SUMMERWIND RANCH AT OAK VALLEY

Specific Plan Area No. 1,
Amendment No. 1



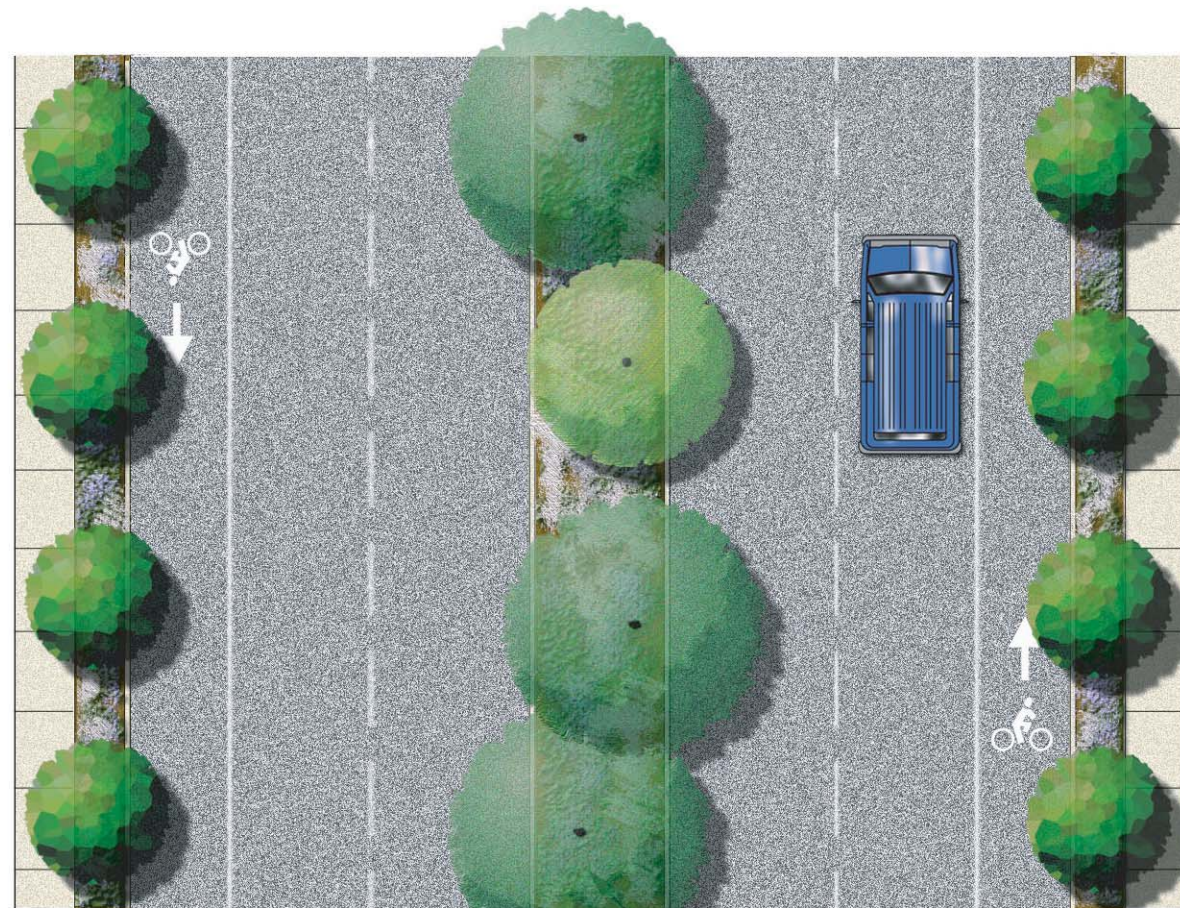
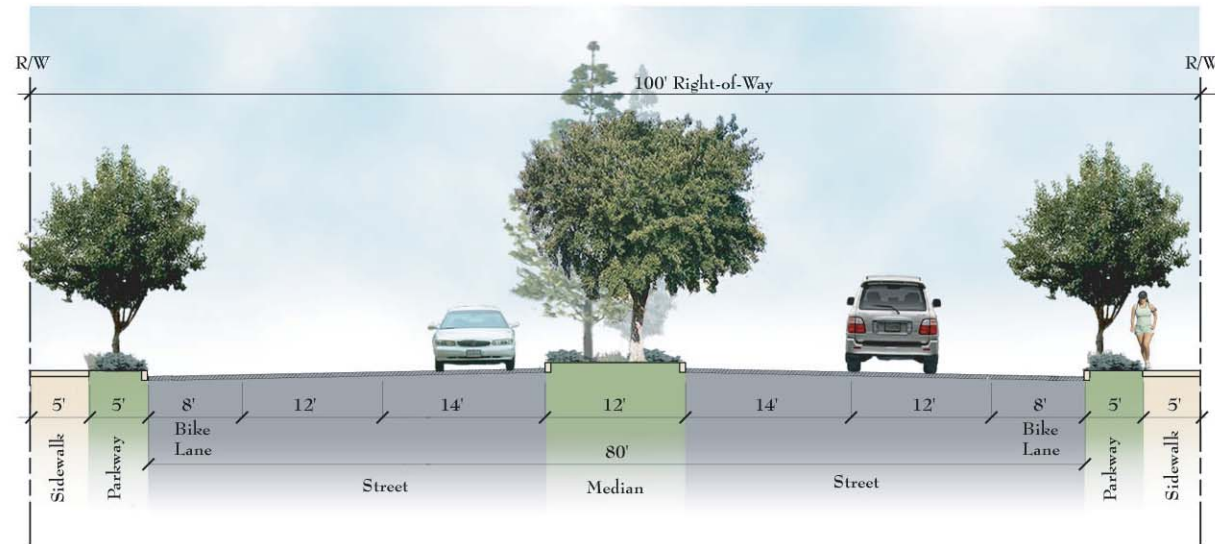

Median trees to be spaced in irregular groupings

Major Highway

Median Trees Such As:

Cinnamomum camphora - Camphor Tree
 Liriodendron tulipifera - Tulip Tree
Pinus canariensis - **Canary Island Pine**
 Pinus eldarica - Eldarica Pine
Quercus suber - **Cork Oak**

Parkway Trees Such As:

Chionanthus retusus - Chinese Fringe Tree
 Chitalpa tashkentensis - Chitalpa
 Koelreuteria bipinnata - Chinese Flame Tree
 Platanus acerfolia - London Plane Tree
 Pinus calleryana 'Bradford' - Bradford Pear
Rhus lancea - **African Sumac**

Shrubs Such As:

Arctostaphylos spp. - manzanita
 Baccharis pilularis - Dwarf Coyote Brush
 Berberis spp. - Barberry
Carissa macrocarpa - **Natal Plum**
 Ceanothus spp. - Wild Lilac
 Cistus spp. - Rockrose
 Encelia farinosa - Brittle Bush
 Grevillea 'Noellii'
 Hesperaloe parviflora - Red Yucca
 Lavandula spp. - Lavender
 Leucophyllum spp. - Texas Ranger
 Punica granatum - Pomegranate
 Rhus ovata - Sugar Bush
 Salvia greggii - Autumn Sage
 Salvia leucantha - Mexican Bush Sage
 Salvia clevelandii - Cleveland Sage
 Sarcococca hookerana humilis - Sweetbox

Ground Cover Such As:

Arctostaphylos 'Emerald Carpet' - Manzanita
 Arctostaphylos 'Monterey Carpet' - Manzanita
 Artemisia caucasia - Silver Spreader
 Baccharis pilularis 'Twin Peaks' - Coyote Brush
 Ceanothus griseus horizontalis 'Yankee Point'
 Convolvulus mauritanicus - Ground Morning Glory
 Juniperus spp. - Juniper
 Myoporum parvifolium
 Oenothera berlandieri - Mexican Primrose
 Rosmarinus officinalis 'Prostratus' - Dwarf Rosemary
 Santolina chamaecyparissus - Lavender Cotton
 Santolina virens - Green Santolina
 Sedum rubrotinctum - Pork and Beans

Grasses Such As:

Boutelous gracilis - Blue Grama Grass
 Carex pausa - California Meadow Sedge
 Elymus 'Canyon Prince' - Blue Wild Rye
 Festuca mairei - Maire's fescue
Festuca ovina glauca - **Blue Fescue**
 Miscanthus transmorrisonensis - Evergreen Eulalia
 Muhlenbergia pubescens - Soft Blue Mexican Muhly

* Red text indicates species represented in rendering. Scenes depict plants in summer.

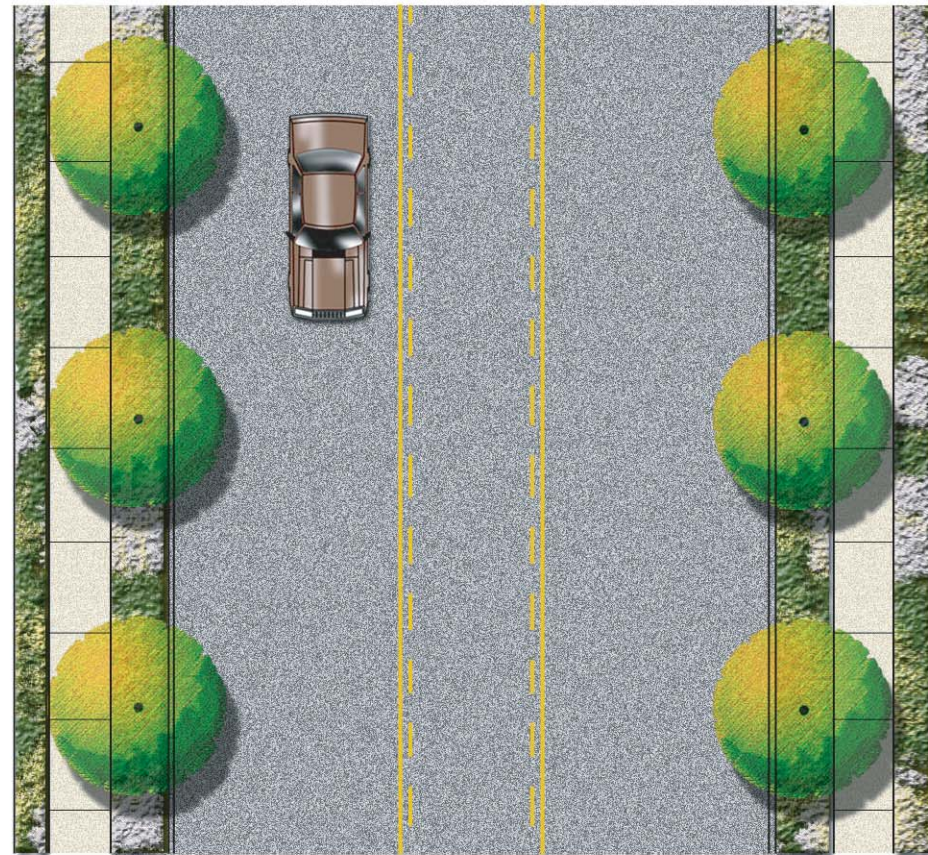
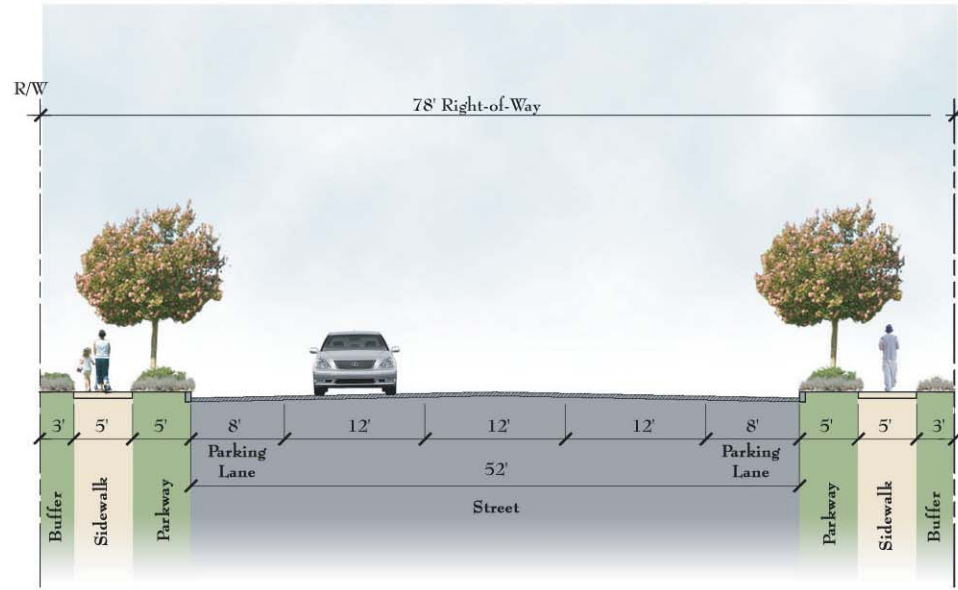

Divided Collector

Parkway Trees Such As:

- Brachychiton populneus - Bottle Tree
- Gleditsia Triacanthos - Honey Locust
- Lagerstroemia indica - Crape Myrtle
- Pistacia chinensis - Chinese Pistache
- Prunus blireiana* - Flowering Plum

Shrubs Such As:

- Arctostaphylos spp. - manzanita
- Baccharis pilularis* - Dwarf Coyote Brush
- Berberis spp. - Barberry
- Carissa macrocarpa - Natal Plum
- Ceanothus spp. - Wild Lilac
- Cistus spp. - Rockrose
- Encelia farinosa - Brittle Bush
- Grevillea 'Noellii'
- Hesperaloe parviflora - Red Yucca
- Lavandula spp. - Lavender
- Leucophyllum spp. - Texas Ranger
- Punica granatum - Pomegranate
- Rhus ovata - Sugar Bush
- Salvia greggii - Autumn Sage
- Salvia leucantha - Mexican Bush Sage
- Salvia clevelandii - Cleveland Sage
- Sarcococca hookerana humilis - Sweetbox

Ground Cover Such As:

- Arctostaphylos 'Emerald Carpet' - Manzanita
- Arctostaphylos 'Monterey Carpet' - Manzanita
- Artemisia caucasia - Silver Spreader
- Baccharis pilularis 'Twin Peaks' - Coyote Brush
- Ceanothus griseus horizontalis 'Yankee Point'
- Convolvulus mauritanicus - Ground Morning Glory
- Juniperus spp. - Juniper
- Myoporum parvifolium
- Oenothera berlandieri - Mexican Primrose
- Rosmarinus officinalis 'Prostratus' - Dwarf Rosemary
- Santolina chamaecyparissus - Lavender Cotton
- Santolina virens - Green Santolina
- Sedum rubrotinctum - Pork and Beans

Grasses Such As:

- Boutelous gracilis - Blue Grama Grass
- Carex pausa - California Meadow Sedge
- Elymus 'Canyon Prince' - Blue Wild Rye
- Festuca mairei - Maire's fescue
- Festuca ovina glauca* - Blue Fescue
- Miscanthus transmorrisonensis - Evergreen Eulalia
- Muhlenbergia pubescens - Soft Blue Mexican Muhly

* Red text indicates species represented in rendering. Scenes depict plants in summer.

Modified Secondary Road

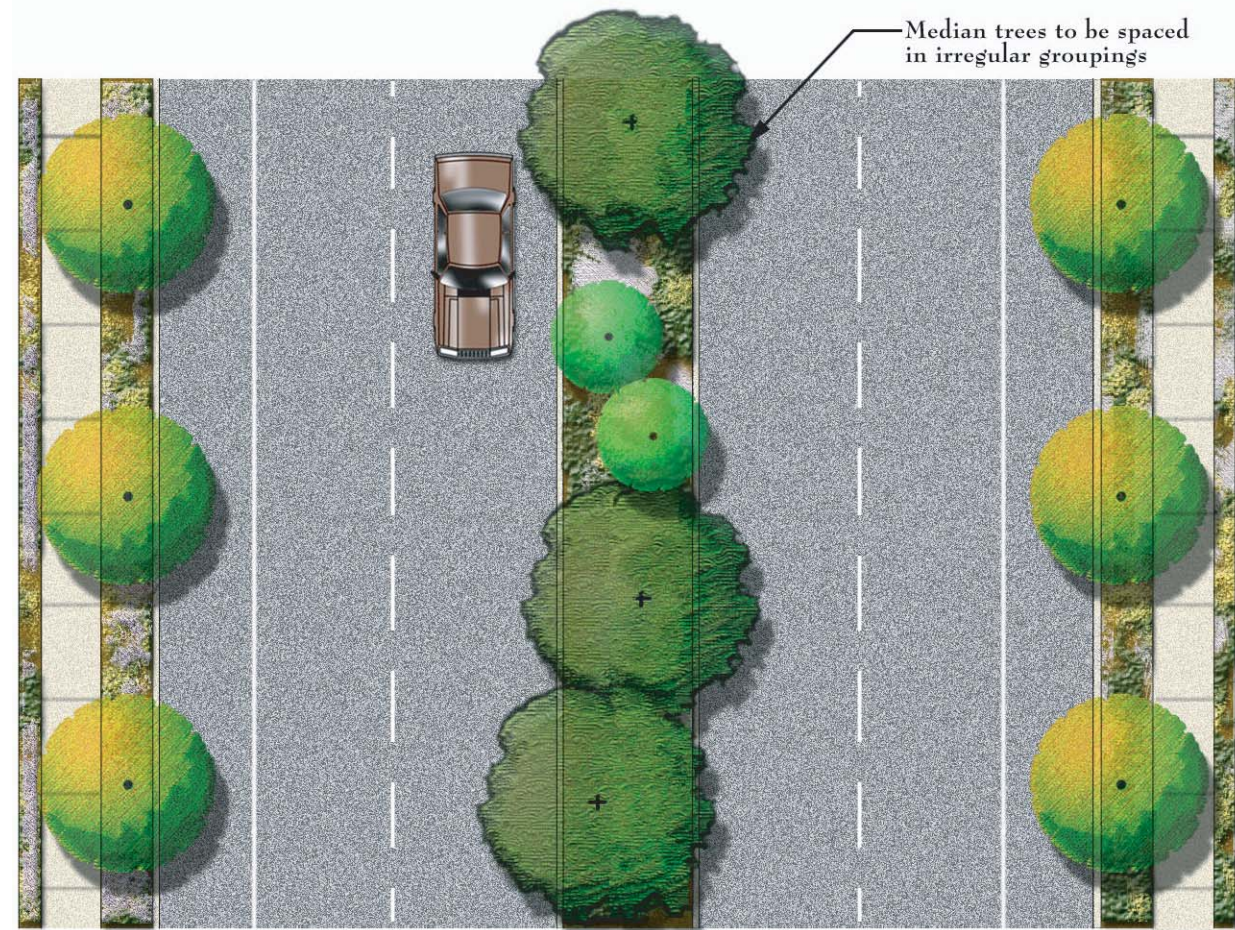
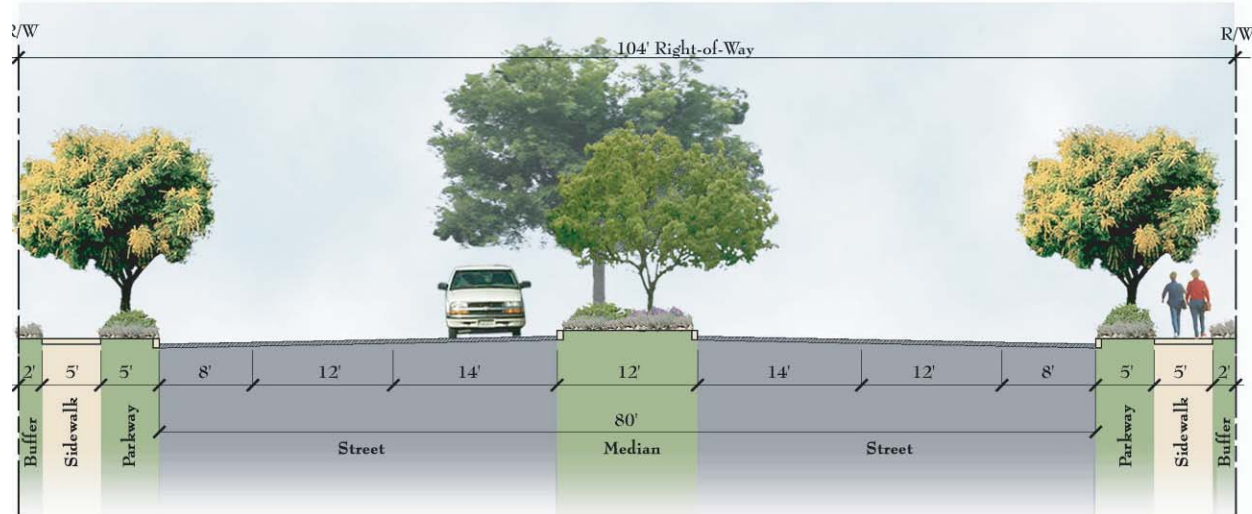

Median trees to be spaced in irregular groupings

Median Trees Such As:

- Cercis occidentalis* - Western Redbud
- Liquidambar styraciflua* - Sweet Gum
- Pinus eldarica* - Eldarica Pine
- Platanus acerfolia* - London Plane Tree
- Podocarpus gracilior* - Fern Pine

Parkway Trees Such As:

- Koelreuteria bipinnata* - Chinese Flame Tree
- Liquidambar styraciflua* - Sweet Gum
- Platanus acerfolia* - London Plane Tree
- Pyrus calleryana* 'Bradford' - Bradford Pear

Shrubs Such As:

- Arctostaphylos* spp. - manzanita
- Baccharis pilularis* - Dwarf Coyote Brush
- Berberis* spp. - Barberry
- Carissa macrocarpa* - Natal Plum
- Ceanothus* spp. - Wild Lilac
- Cistus* spp. - Rockrose
- Encelia farinosa* - Brittle Bush
- Grevillea* 'Noellii'
- Hesperaloe parviflora* - Red Yucca
- Lavandula* spp. - Lavender
- Leucophyllum* spp. - Texas Ranger
- Punica granatum* - Pomegranate
- Rhus ovata* - Sugar Bush
- Salvia greggii* - Autumn Sage
- Salvia leucantha* - Mexican Bush Sage
- Salvia clevelandii* - Cleveland Sage
- Sarcococca hookerana humilis* - Sweetbox

Ground Cover Such As:

- Arctostaphylos* 'Emerald Carpet' - Manzanita
- Arctostaphylos* 'Monterey Carpet' - Manzanita
- Artemisia caucasia* - Silver Spreader
- Baccharis pilularis* 'Twin Peaks' - Coyote Brush
- Ceanothus griseus horizontalis* 'Yankee Point'
- Convolvulus mauritanicus* - Ground Morning Glory
- Juniperus* spp. - Juniper
- Myoporum parvifolium*
- Oenothera berlandieri* - Mexican Primrose
- Rosmarinus officinalis* 'Prostratus' - Dwarf Rosemary
- Santolina chamaecyparissus* - Lavender Cotton
- Santolina virens* - Green Santolina
- Sedum rubrotinctum* - Pork and Beans

Grasses Such As:

- Boutelous gracilis* - Blue Grama Grass
- Carex pausa* - California Meadow Sedge
- Elymus* 'Canyon Prince' - Blue Wild Rye
- Festuca mairei* - Maire's fescue
- Festuca ovina glauca* - Blue Fescue
- Miscanthus transmorrisonensis* - Evergreen Eulalia
- Muhlenbergia pubescens* - Soft Blue Mexican Muhly

* Red text indicates species represented in rendering. Scenes depict plants in summer.

SUMMERWIND RANCH AT OAK VALLEY

Specific Plan Area No. 1,
Amendment No. 1



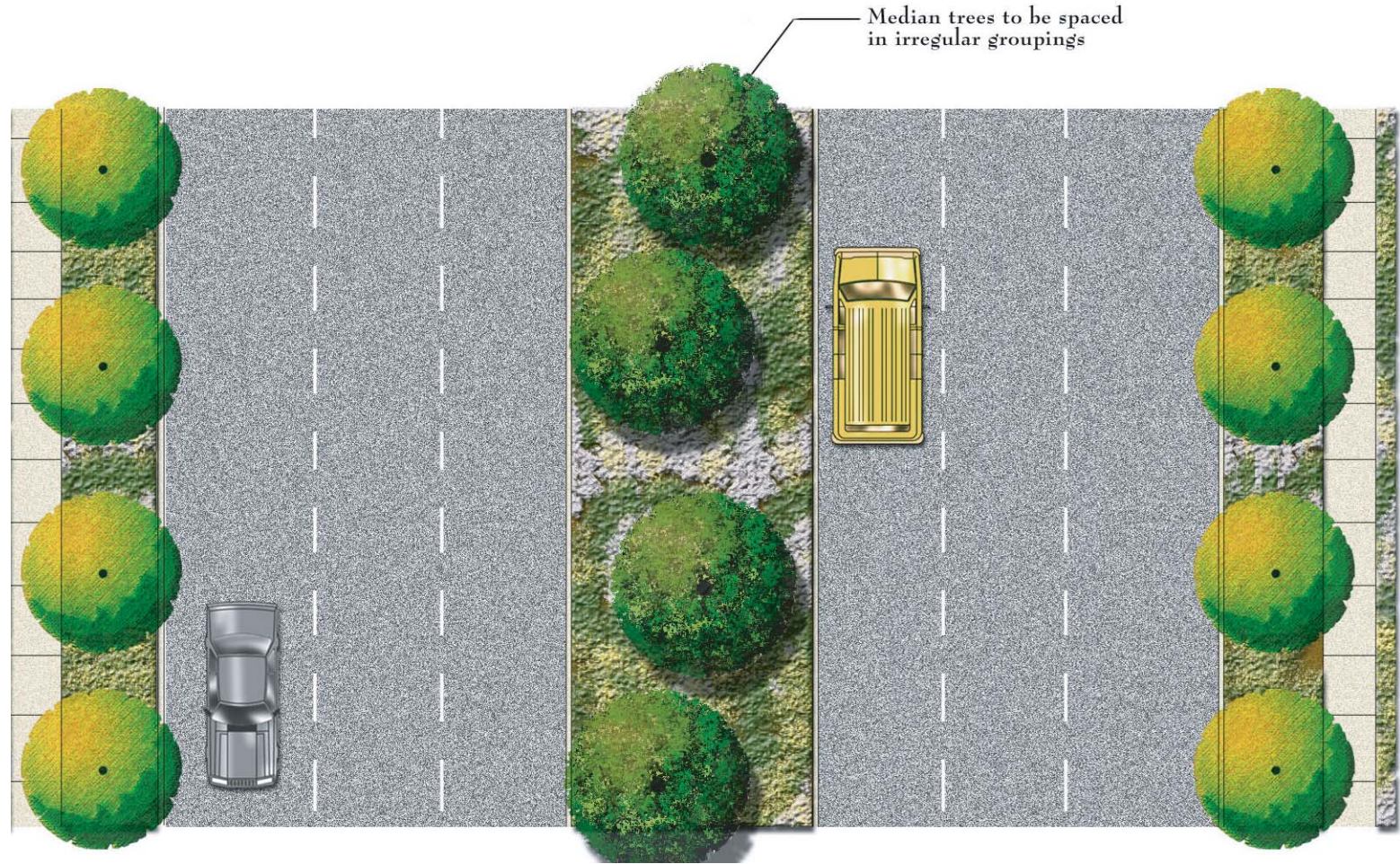
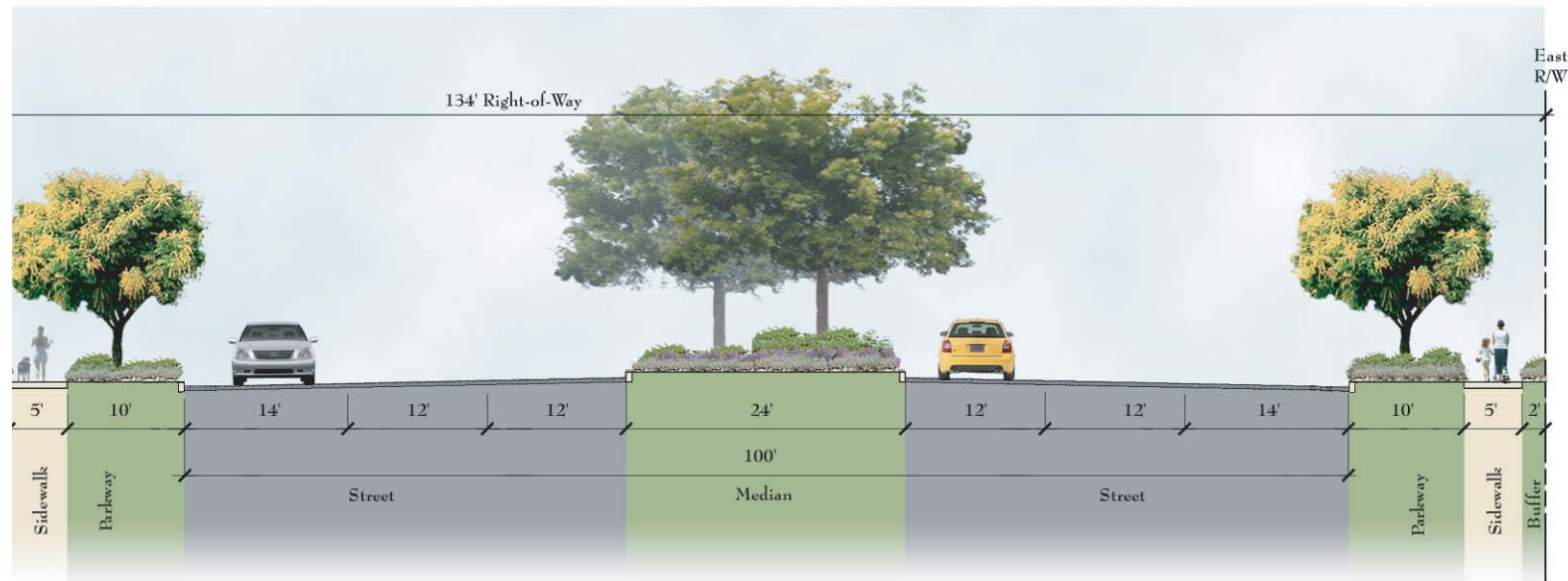

Urban Arterial

Median Trees Such As:

- Albizia julibrissin - Silk Tree
- Cinnamomum camphora - Camphor Tree**
- Pinus halepensis - Aleppo Pine
- Pyrus calleryana 'Bradford' - Bradford Pear
- Quercus ilex - Holly Oak
- Quercus virginiana - Live Oak
- Liriodendron tulipifera - Tulip Tree

Parkway Trees Such As:

- Geijera parviflora - Australian Willow
- Koelreuteria bipinnata - Chinese Flame Tree**
- Platanus acerfolia - London Plane Tree
- Pyrus calleryana 'Bradford' - Bradford Pear

Shrubs Such As:

- Arctostaphylos spp. - manzanita
- Baccharis pilularis - Dwarf Coyote Brush
- Berberis spp. - Barberry
- Carissa macrocarpa - Natal Plum**
- Ceanothus spp. - Wild Lilac
- Cistus spp. - Rockrose
- Encelia farinosa - Brittle Bush
- Grevillea 'Noellii'
- Hesperaloe parviflora - Red Yucca
- Lavandula spp. - Lavender
- Leucophyllum spp. - Texas Ranger
- Punica granatum - Pomegranate
- Rhus ovata - Sugar Bush
- Salvia greggii - Autumn Sage
- Salvia leucantha - Mexican Bush Sage
- Salvia clevelandii - Cleveland Sage
- Sarcococca hookerana humilis - Sweetbox

Ground Cover Such As:

- Arctostaphylos 'Emerald Carpet' - Manzanita
- Arctostaphylos 'Monterey Carpet' - Manzanita
- Artemisia caucasia - Silver Spreader
- Baccharis pilularis 'Twin Peaks' - Coyote Brush
- Ceanothus griseus horizontalis 'Yankee Point'
- Convolvulus mauritanicus - Ground Morning Glory
- Juniperus spp. - Juniper
- Myoporum parvifolium
- Oenothera berlandieri - Mexican Primrose
- Rosmarinus officinalis 'Prostratus' - Dwarf Rosemary
- Santolina chamaecyparissus - Lavender Cotton
- Santolina virens - Green Santolina
- Sedum rubrotinctum - Pork and Beans

Grasses Such As:

- Boutelous gracilis - Blue Grama Grass
- Carex pausa - California Meadow Sedge
- Elymus 'Canyon Prince' - Blue Wild Rye
- Festuca mairei - Maire's fescue
- Festuca ovina glauca - Blue Fescue**
- Miscanthus transmorrisonensis - Evergreen Eulalia
- Muhlenbergia pubescens - Soft Blue Mexican Muhly

* Red text indicates species represented in rendering. Scenes depict plants in summer.

SUMMERWIND RANCH AT OAK VALLEY

Specific Plan Area No. 1,
Amendment No. 1



FIGURE IV-41
Urban Arterial Highway Streetscape

2. Landscape Interfaces

Edge conditions within the SUMMERWIND RANCH AT OAK VALLEY community are variable and the landscape treatment is designed to respond to the various land uses. The community edges will blend in with the existing vegetation and forest edges to become one harmonious landscape setting.

- ❑ **Edge Condition – Residential/Natural Open Space**
Instances where residential uses meet natural open space uses are depicted in Figure 4-42, *Edge Condition – Residential/Natural Open Space*. They are typically separated by a view fence.
- ❑ **Edge Condition – Residential/Riparian Corridor**
Instances where residential uses meet the riparian corridor are depicted in Figure 4-43, *Edge Condition – Residential/Riparian Corridor*. They are typically separated by a view fence.
- ❑ **Edge Condition – Residential/Recreation Center**
Instances where residential uses meet the recreation center are depicted in Figure 4-44, *Recreation Center Illustration*. In plan view it can be noted that there is a landscape buffer and view fence or block wall, often with natural open space and preserved Oak groves in the vicinity.
- ❑ **Edge Condition – Residential/Passive Park**
Instances where residential uses meet pocket parks are depicted in Figure 4-45, *Edge Condition – Residential/Passive Park*. They are separated by a landscape buffer and view fence or block wall.
- ❑ **Edge Condition – Residential/Linear Park**
Instances where residential uses meet linear parks are depicted in Figure 4-46, *Edge Condition – Residential/Linear Park*. They are separated by naturalized slope planting and view fence or block wall.
- ❑ **Edge Condition – Residential/School, School/Park, and Park/Open Space**
Figure 4-47, *Edge Condition – Residential/School, School/Park, and Park/Open Space* shows three edge conditions. They are separated by landscape buffers.
- ❑ **Edge Condition – Sideyard**
Figure 4-48, *Edge Condition – Sideyard* shows an example of this kind of buffer.
- ❑ **Edge Condition – Commercial/I-10 Freeway**
Figure 4-49, *Edge Condition – Commercial/I-10 Freeway* shows an example of this type of buffer.
- ❑ **Edge Condition – Residential/I-10 Freeway**
Figure 4-50, *Edge Condition – Residential/I-10 Freeway* shows an example of this type of buffer.

- **Edge Condition – Residential/Commercial**
Figure 4-51, *Edge Condition – Residential/Commercial* shows an example of this type of buffer.

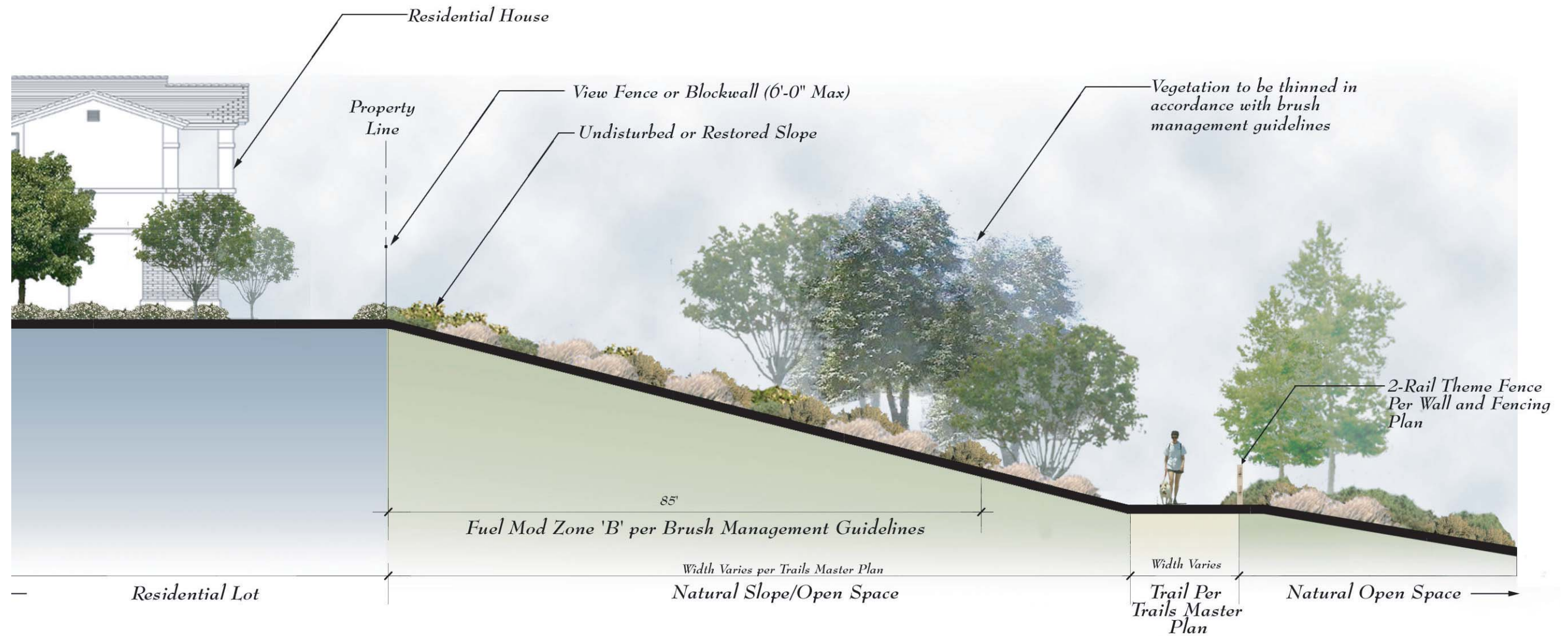

SUMMERWIND RANCH AT OAK VALLEY

Specific Plan Area No. 1,
Amendment No. 1



Edge Condition - Residential/Natural Open Space

FIGURE IV-42

PAGE IV-80

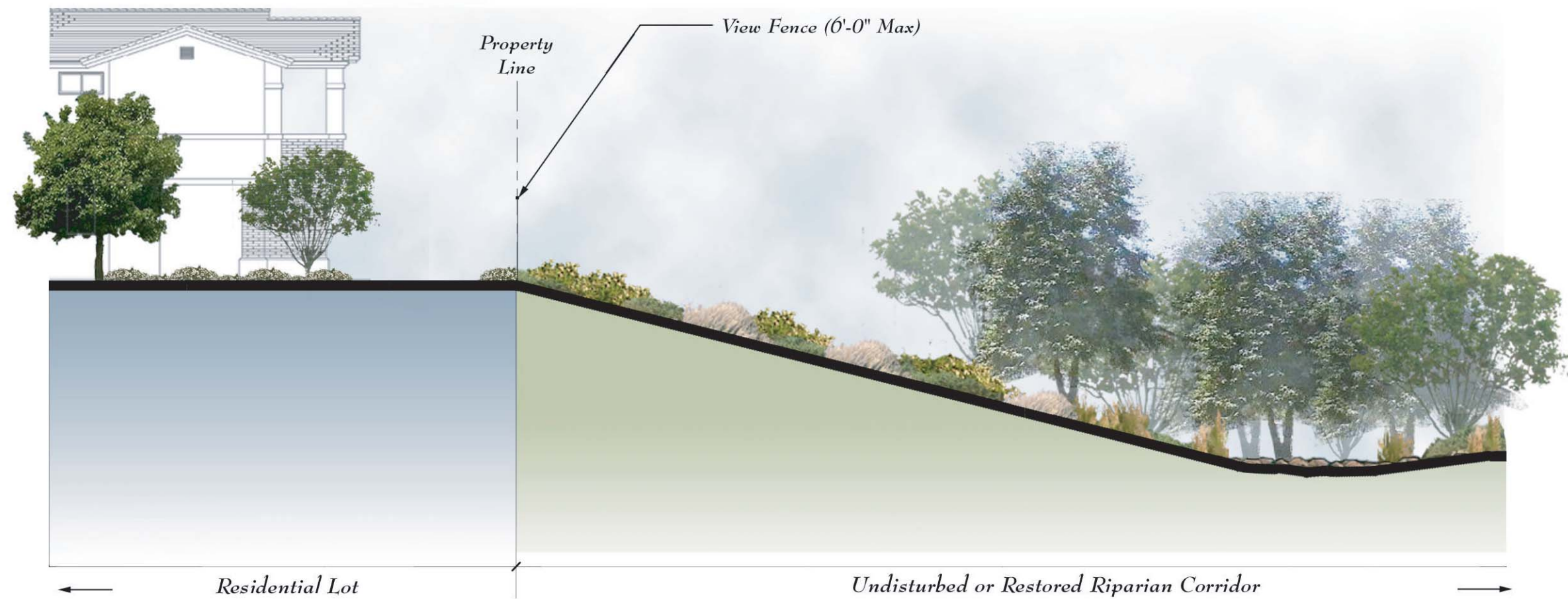

SUMMERWIND RANCH AT OAK VALLEY

Specific Plan Area No. 1,
Amendment No. 1



Edge Condition - Residential/Riparian Corridor

FIGURE IV-43

PAGE IV-81

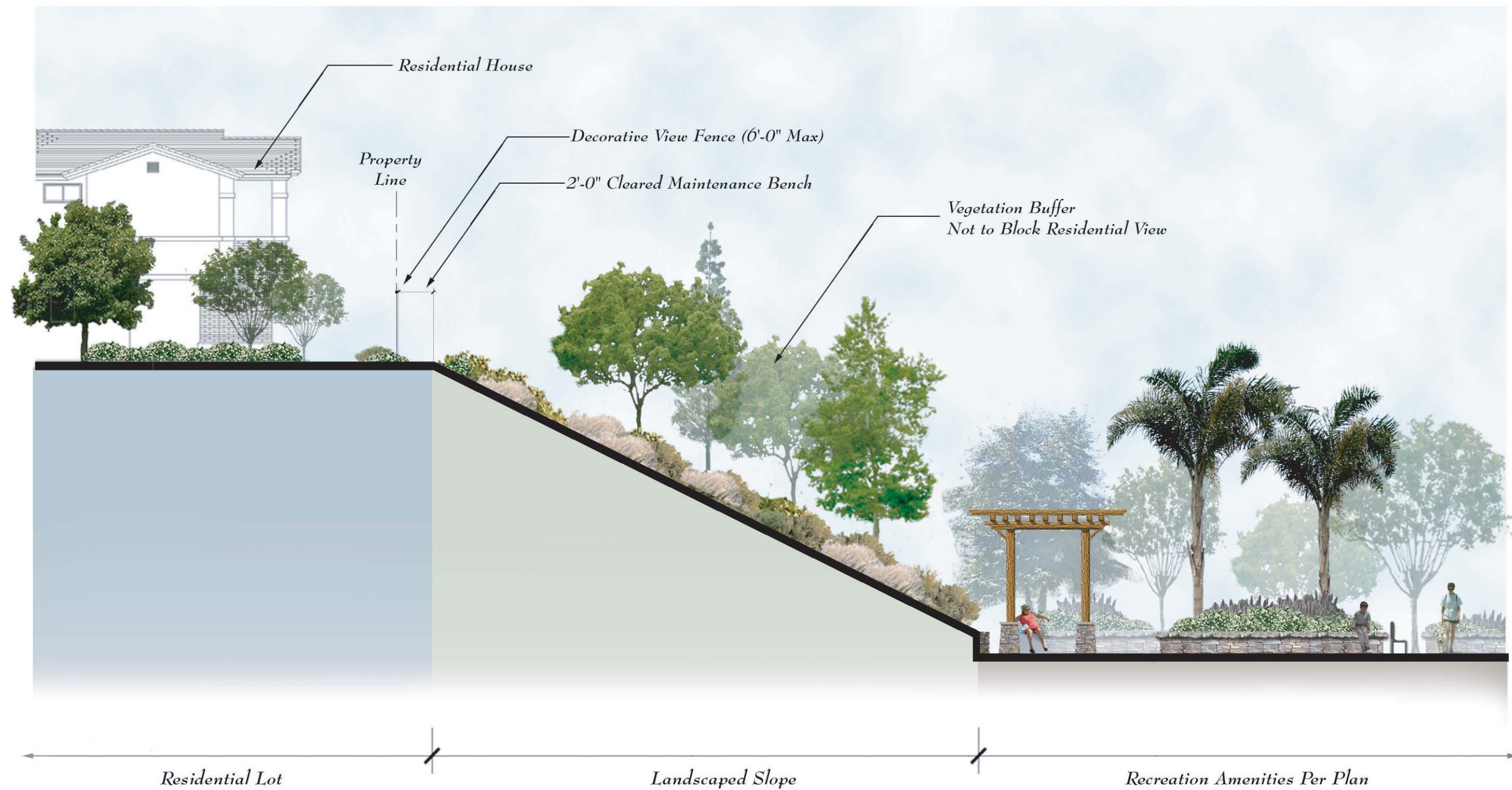

SUMMERWIND RANCH AT OAK VALLEY

Specific Plan Area No. 1,
Amendment No. 1



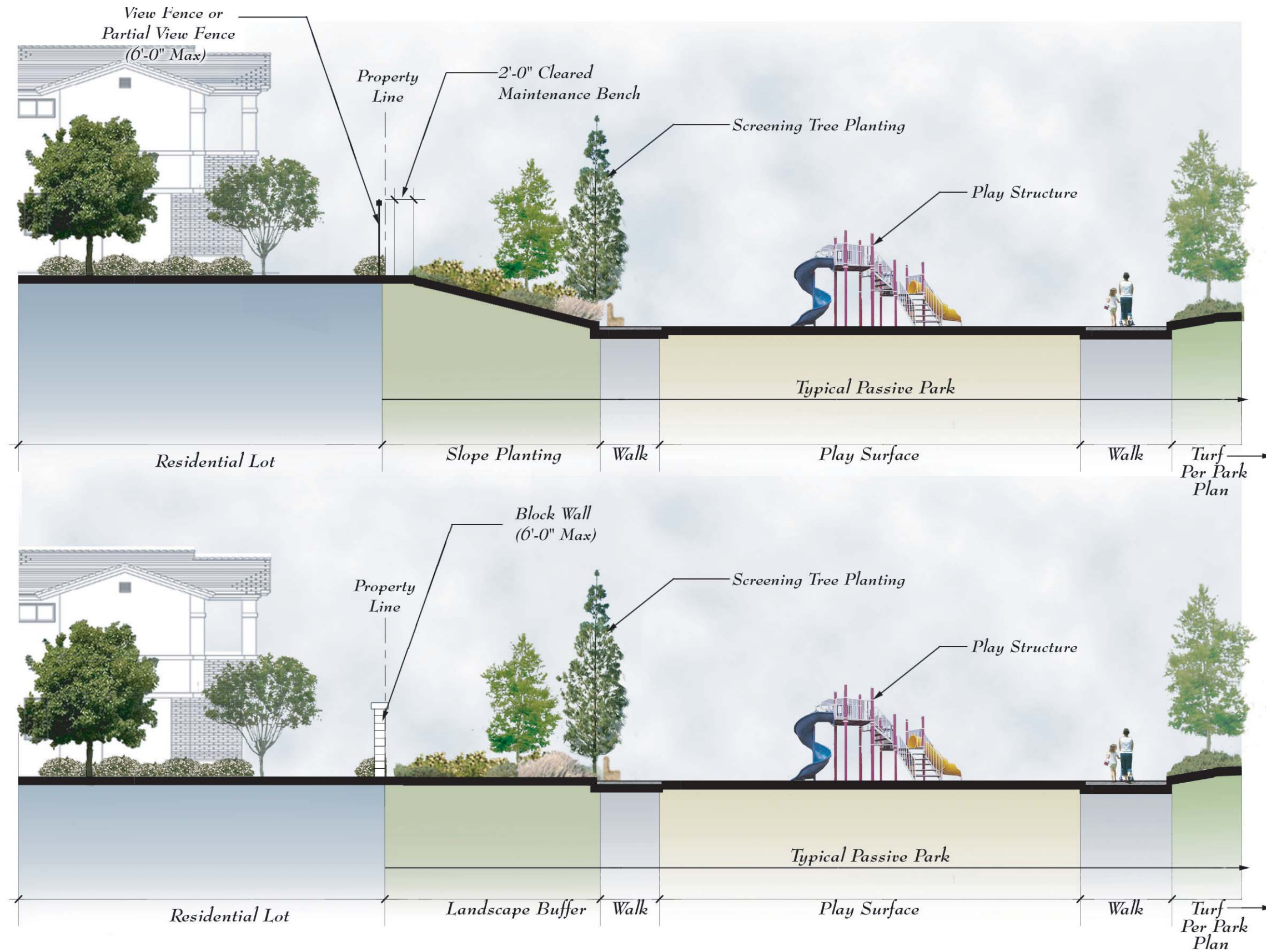

SUMMERWIND RANCH AT OAK VALLEY

Specific Plan Area No. 1,
Amendment No. 1



FIGURE IV-45
Edge Condition - Residential-Passive Park

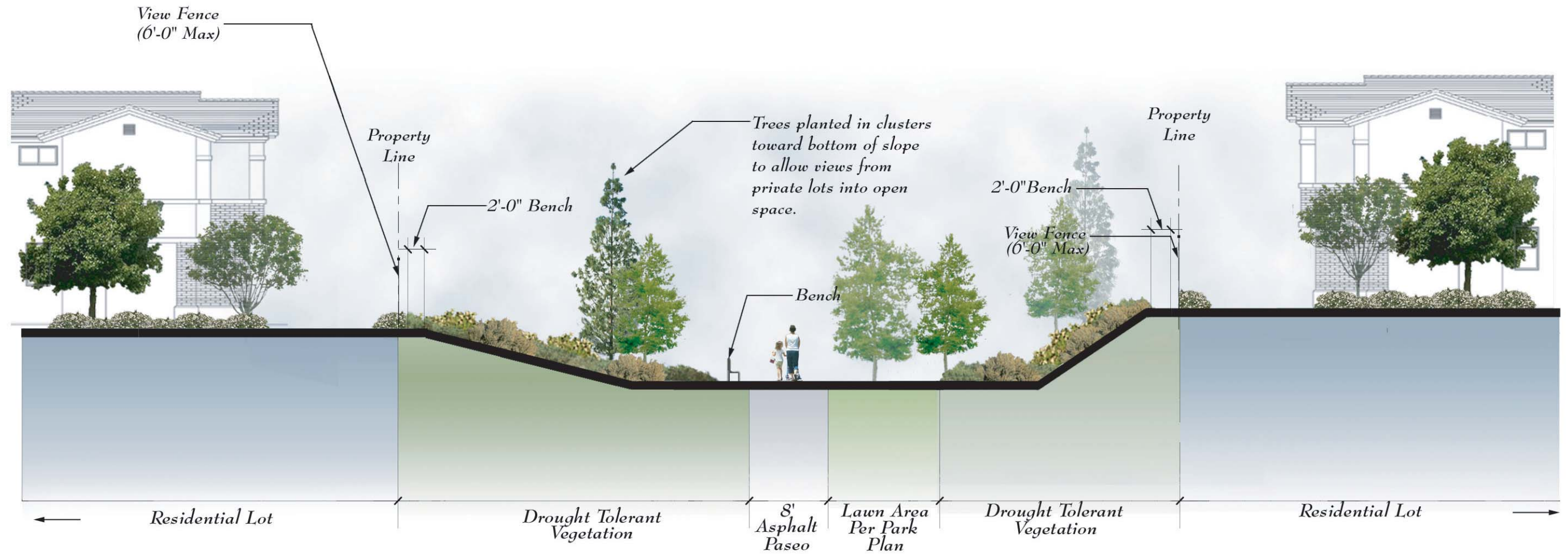

SUMMERWIND RANCH AT OAK VALLEY

Specific Plan Area No. 1,
Amendment No. 1



FIGURE IV-46
Edge Condition - Residential/Linear Park

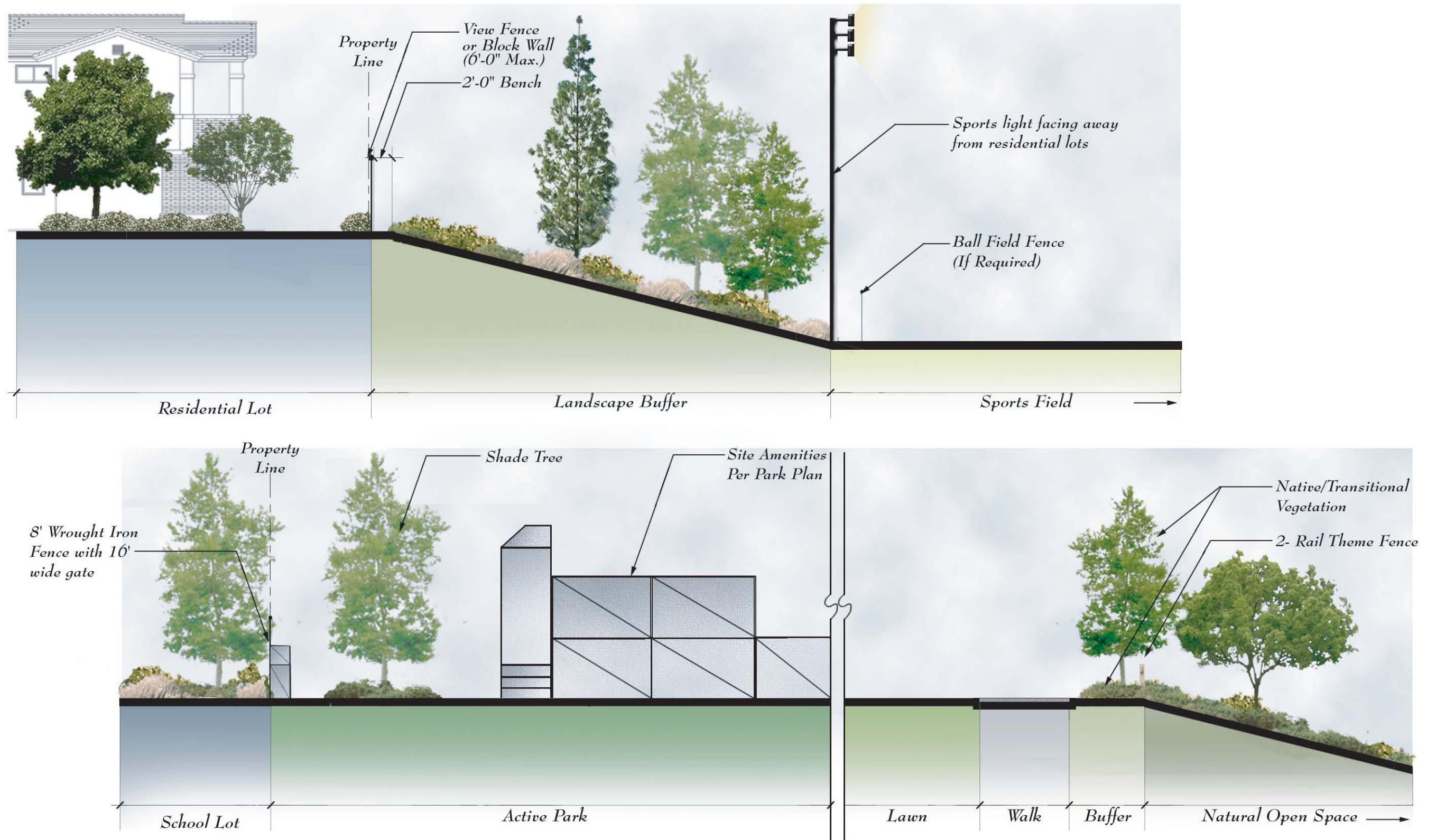

SUMMERWIND RANCH AT OAK VALLEY

Specific Plan Area No. 1,
Amendment No. 1



Edge Condition - Residential/School, School/Park, and Park/Open Space

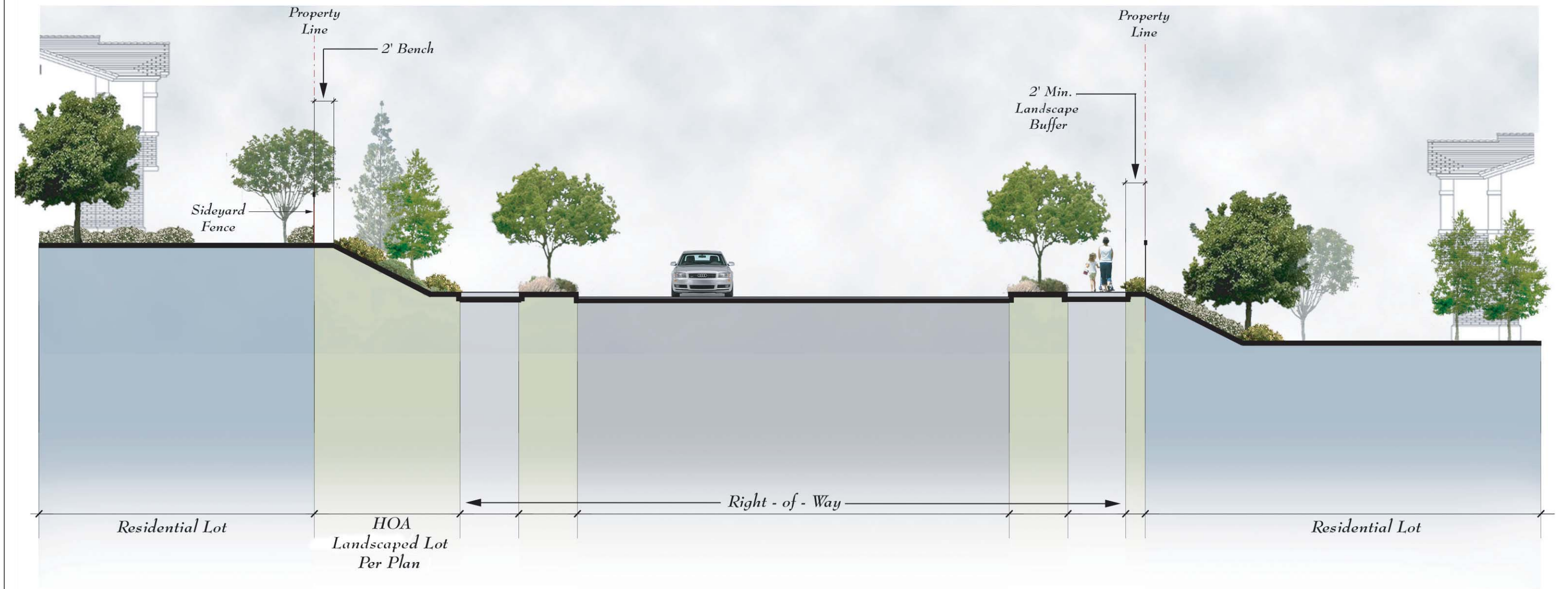

SUMMERWIND RANCH AT OAK VALLEY

Specific Plan Area No. 1,
Amendment No. 1



FIGURE IV-48

Edge Condition - Sideyard

PAGE IV-86

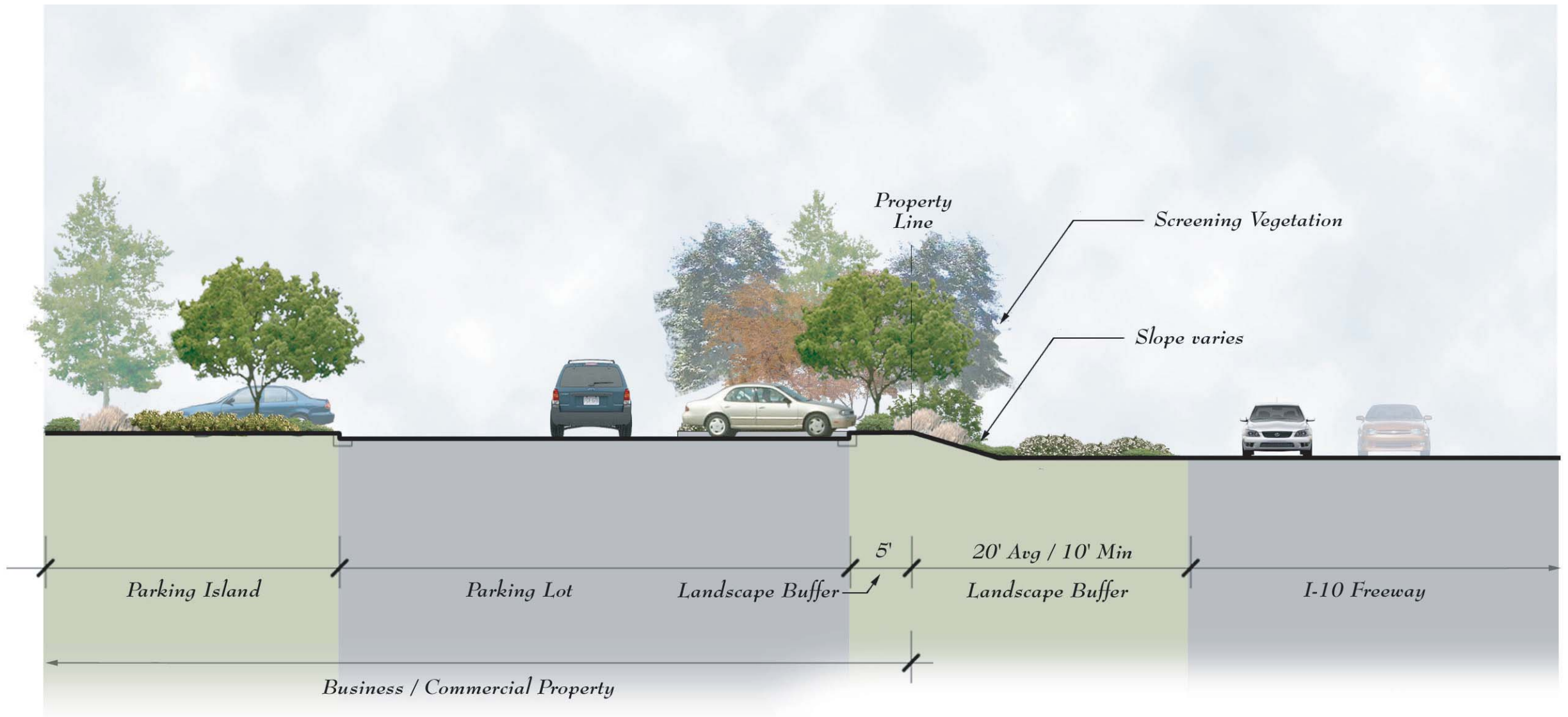

SUMMERWIND RANCH AT OAK VALLEY

Specific Plan Area No. 1,
Amendment No. 1



FIGURE IV-49

Edge Condition - Commercial/I-10 Freeway

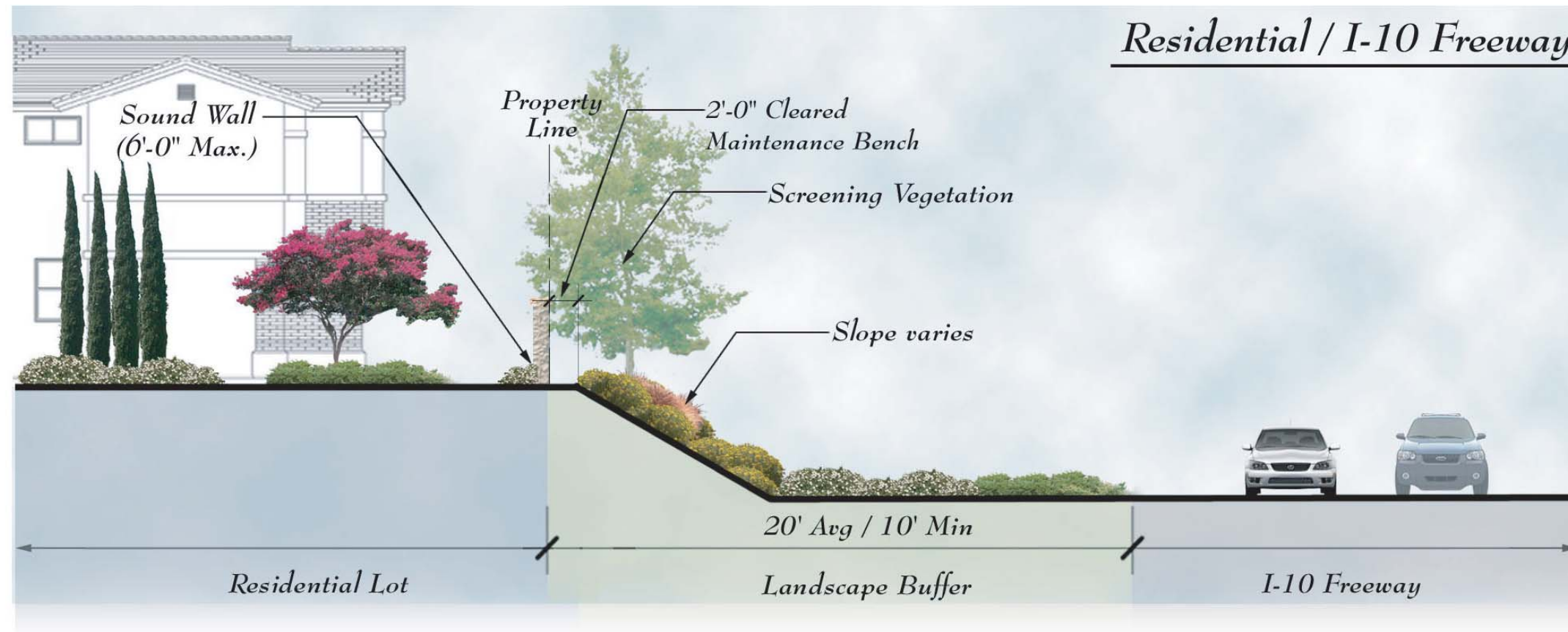

SUMMERWIND RANCH AT OAK VALLEY

Specific Plan Area No. 1,
Amendment No. 1



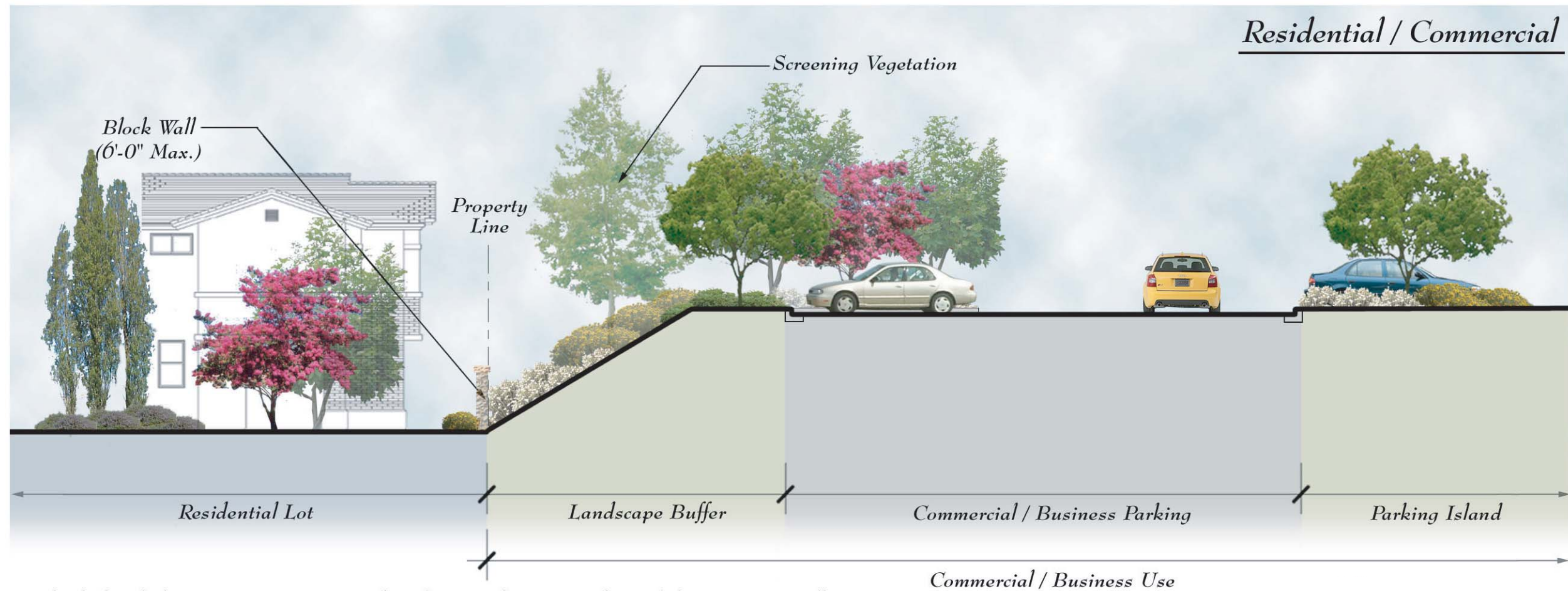

** Multiple family housing/ open space, and parking configurations for each housing type will vary.*

SUMMERWIND RANCH AT OAK VALLEY

Specific Plan Area No. 1,
Amendment No. 1



FIGURE IV-51

Edge Condition - Residential/Commercial

PAGE IV-89

3. Community Walls and Fences

Community walls and fences, as illustrated on Figure 4-52, *Wall & Fence Plan*; Figure 4-53, *Wall & Fence Details – A*; and Figure 4-54, *Wall & Fence Details – B*, will be predominantly located around the perimeter boundaries of each residential planning area where interfaces with natural open space, roads, parks, or off-site land uses occur. The walls and fencing within the SUMMERWIND RANCH AT OAK VALLEY project site are major visual elements and have been carefully designed to complement the overall theme. A strong cohesive appearance is achieved through the use of “community walls” and general overall wall guidelines. The walls and fencing will be easy to maintain and provide a durable, long-term edge.

Community walls and fences shall be designed as an integral component and extension of the building design and surrounding landscape. Periphery walls may be integrated into the adjacent structure and extended into the landscape to help integrate the building into its environment. Walls and fences shall be constructed of materials, colors, and textures that are similar and harmonious with the architecture. Particular importance shall be given to railing and cap details. Walls and fences may be offset occasionally to avoid visual monotony. Variety in materials, design and height is encouraged. Fencing and walls shall be used to define the limits of property ownership, as well as for the creation of exterior privacy.

4. Community Amenities

A variety of recreational opportunities will be afforded within SUMMERWIND RANCH AT OAK VALLEY. These are depicted on Figure 4-55, *Parks and Open Space Concept Plan*. Outdoor recreation experiences will be promoted through the development of a quantity of quality parks. Community lifestyle needs have been anticipated with a variety of recreation experiences which are provided by nearby neighborhood parks, the expansive natural open space areas and the on-site greenbelt/paseo trails network.

☐ Conceptual Active Parks

Activity parks will include uses such as sports fields, tot lots, picnic areas, natural areas, and parking. Examples of the activity parks can be found in Figure 4-56, *Conceptual Active Park Illustration – A*, Figure 4-57, *Conceptual Active Park Illustration – B*; Figure 4-58, *Conceptual Active Park Illustration – C*, and Figure 4-59, *Conceptual Active Park Illustration – D*.

☐ Nature Parks

Nature Parks are primarily preserved natural space with small elements such as tot lots and pedestrian trails running through them. They also have amenities such as scenic overlooks, educational gardens and trails, and informational signs. An example of this can be found in Figure 4-60, *Nature Park*.

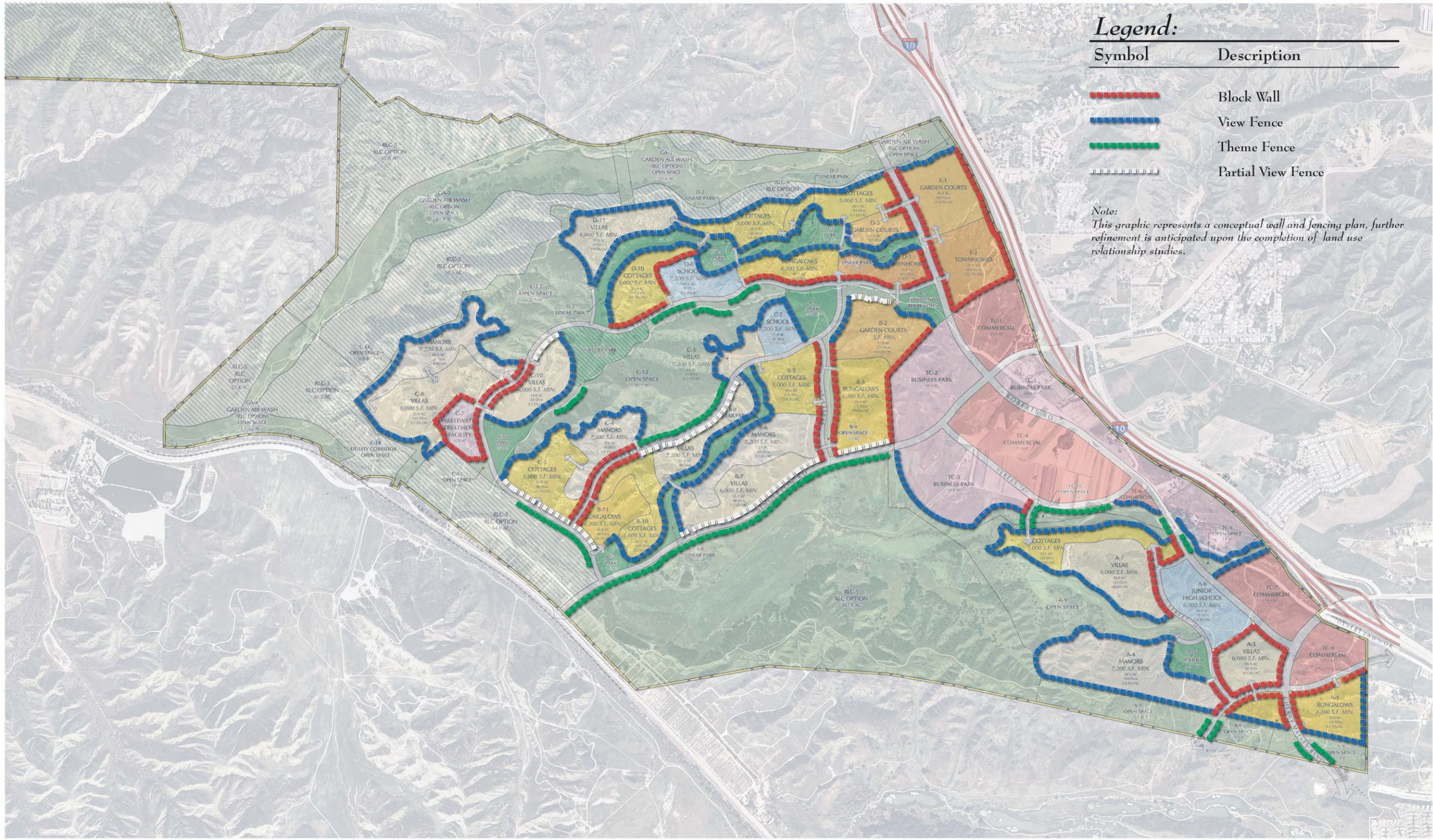

Legend:

Symbol	Description
	Block Wall
	View Fence
	Theme Fence
	Partial View Fence

Note:
This graphic represents a conceptual wall and fencing plan, further refinement is anticipated upon the completion of land use relationship studies.

SUMMERWIND RANCH AT OAK VALLEY

Specific Plan Area No. 1,
Amendment No. 1



FIGURE IV-52
Wall & Fence Plan

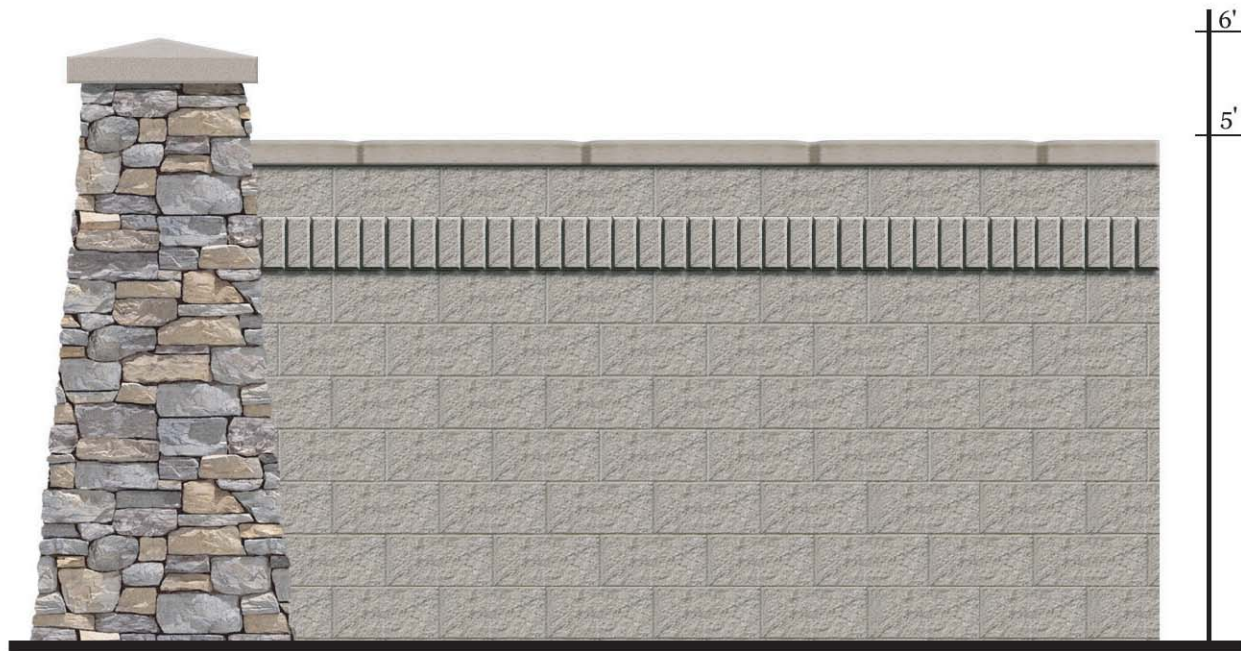

Block Wall

Description: ■■■■■■■■

- Split face block with wall cap and half block soldier course.
- Battered pilaster with stone veneer concrete cap in accent areas.

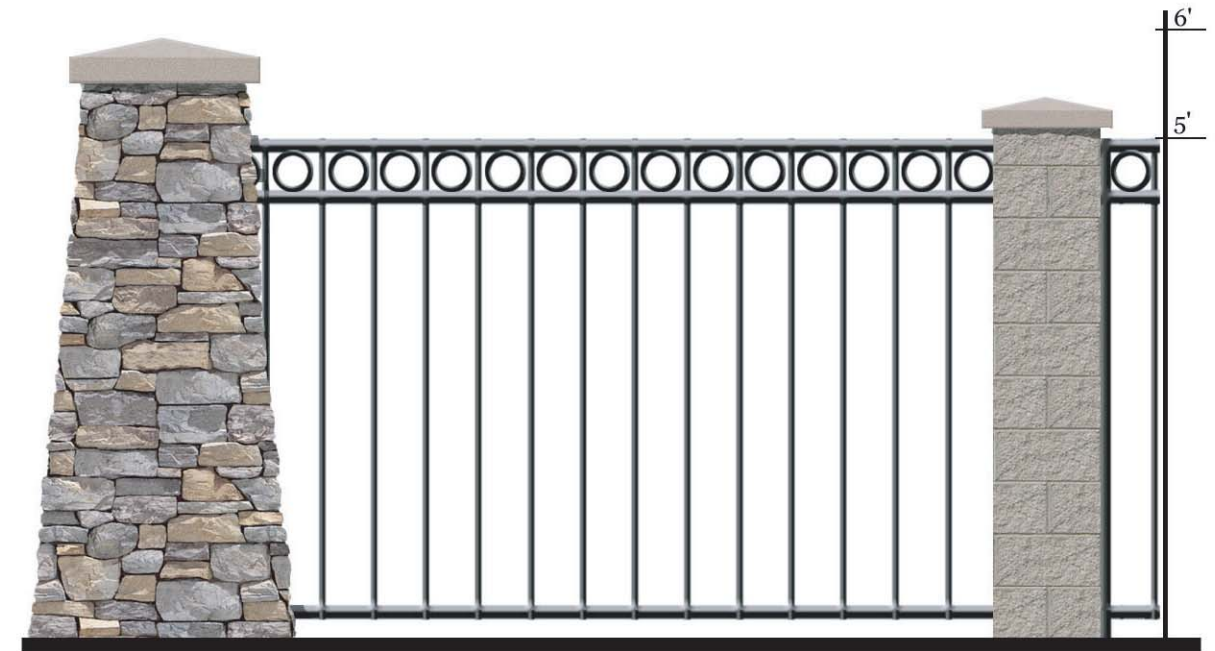

Full View Fence in Accent Areas

Description: ■■■■■■■■

- Tubular stainless steel full view fence with ornamental trim.
- Battered pilaster with stone veneer and concrete cap at accent areas.

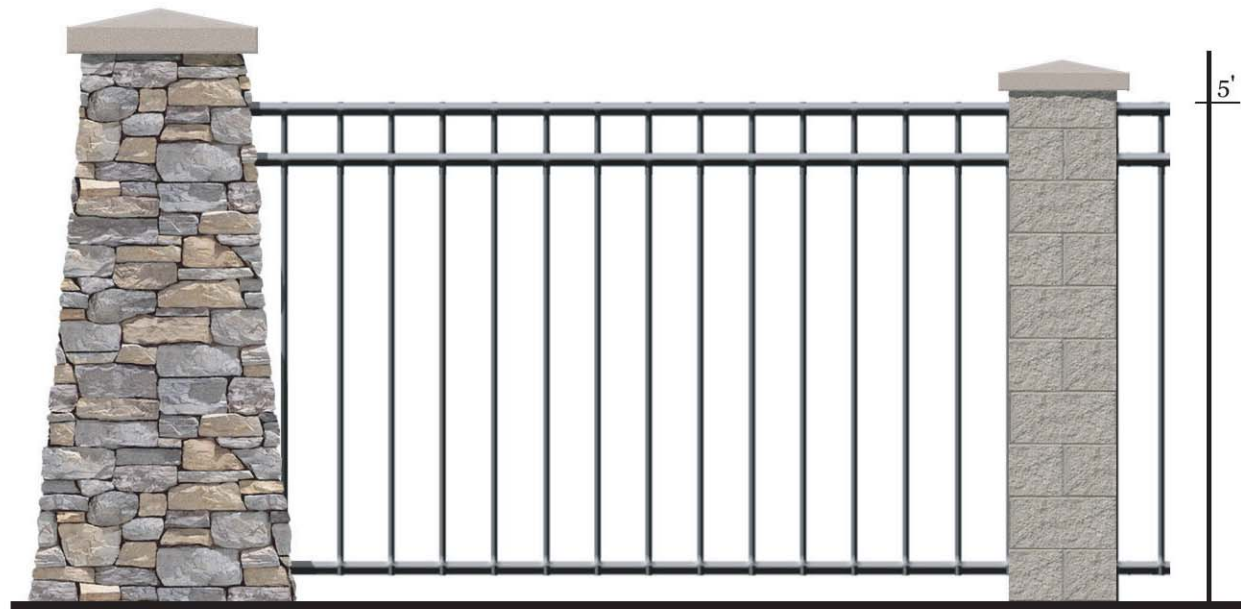

Full View Fence

Description: ■■■■■■■■

- Tubular stainless steel full view fence.
- Battered pilaster with stone veneer and concrete cap at accent areas.



Theme Fence

Description: ■■■■■■■■

- Two rail woodcrete theme fence.
- Stone veneer pilaster with concrete cap at intersections.

SUMMERWIND RANCH AT OAK VALLEY

Specific Plan Area No. 1,
Amendment No. 1



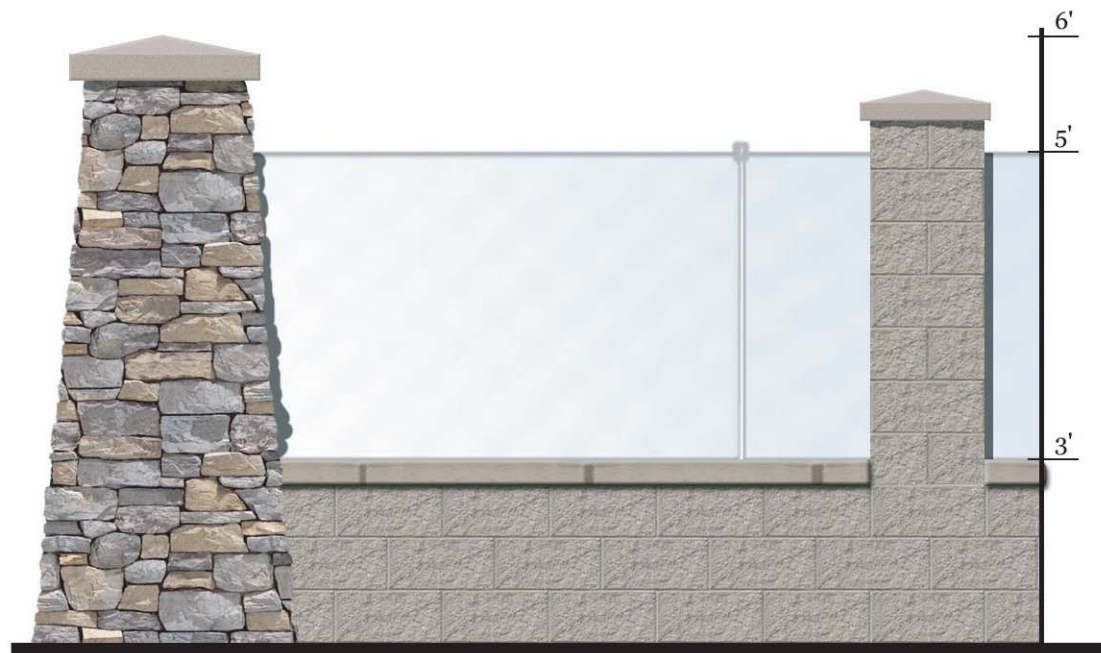

Partial View Fence

Description:

- 2' Split face block with wall cap.
- 3' Plexi-glass view fence.
- Battared stone veneer pilaster with concrete cap in accent areas..



Interior Side Yard Fence

Description:

- Natural wood fence

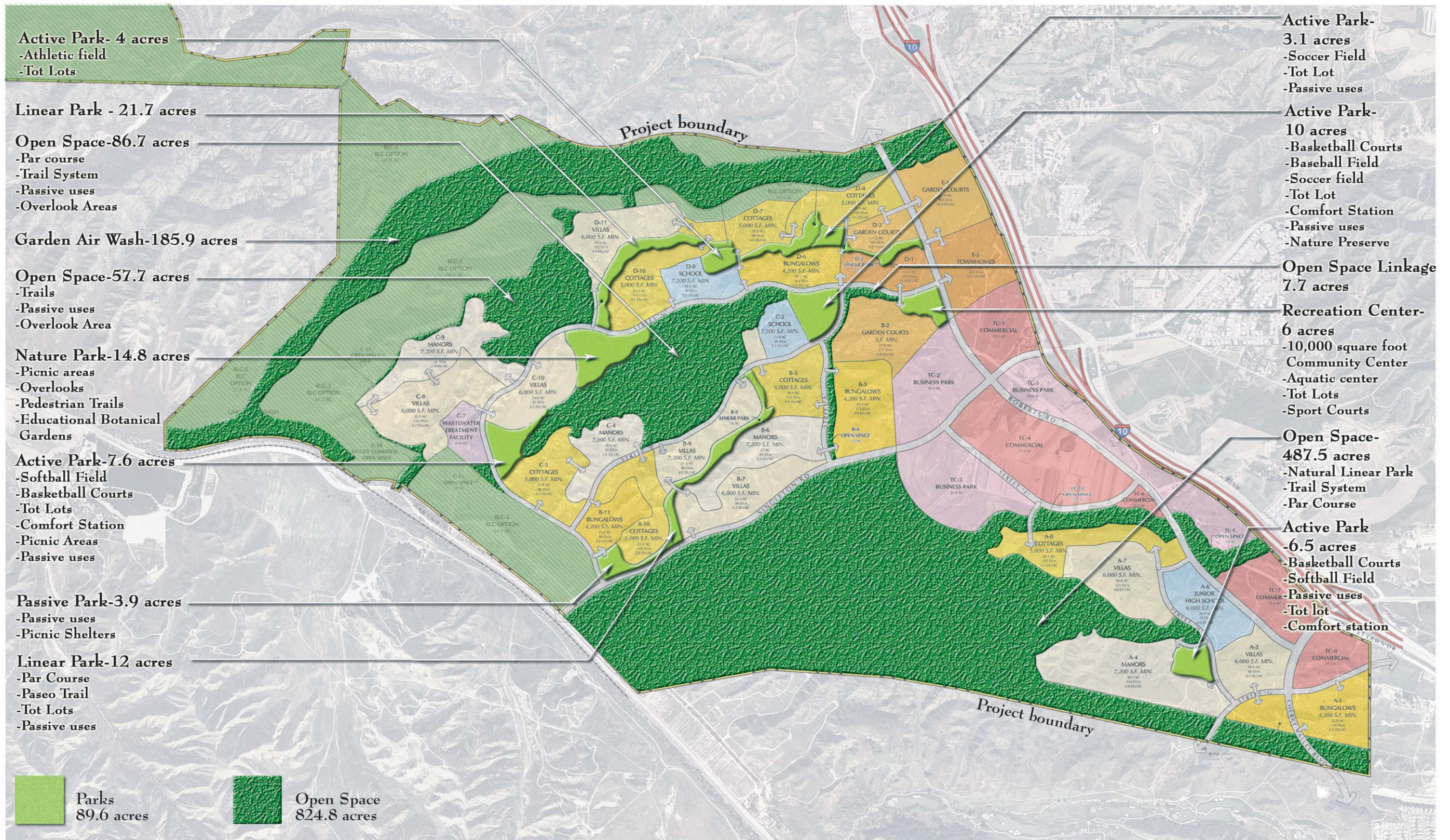

Note: The program elements depicted in this graphic represent a preliminary concept of recreational uses. Further refinement is anticipated.

SUMMERWIND RANCH AT OAK VALLEY

Specific Plan Area No. 1,
Amendment No. 1





SUMMERWIND RANCH AT OAK VALLEY

Specific Plan Area No. 1,
Amendment No. 1



FIGURE IV-56

Active Park A



Legend

Symbol	Description
	Existing tree
	Large canopy tree
	Ornamental / shade tree
	Residential lot
	Slope treatment/ Open space
	Shrub planting
	Turf
	Asphalt
	Trail Head Monument

Description

Design Guidelines

This active park should have a multi-use field, tot-lot area and passive lawn areas. There shall be a connection to the community trail system, as well as a connection to the linear park to the east. Shaded picnic areas should be provided throughout the park and should be ADA compliant. On-site parking should be provided as well as a pedestrian entrance to the north.

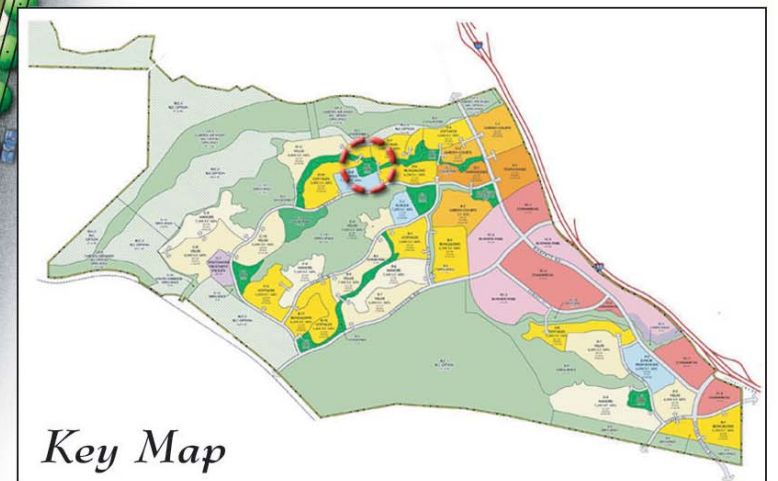

SUMMERWIND RANCH AT OAK VALLEY

Specific Plan Area No. 1,
Amendment No. 1





Legend

Symbol	Description
	Existing Tree
	Large canopy tree
	Ornamental / shade tree
	Residential lot
	Slope treatment
	Shrub planting
	Turf
	Asphalt

Description

Design Guidelines

This park will act as the main active park of the northern phases of the community. The park shall have both a softball/little league field and a multi-use field. There should be access to the adjacent school and community paseo trail. This park will have a comfort station, tot-lots, on-site parking, and passive use/picnic areas. All park amenities shall be ADA compliant.

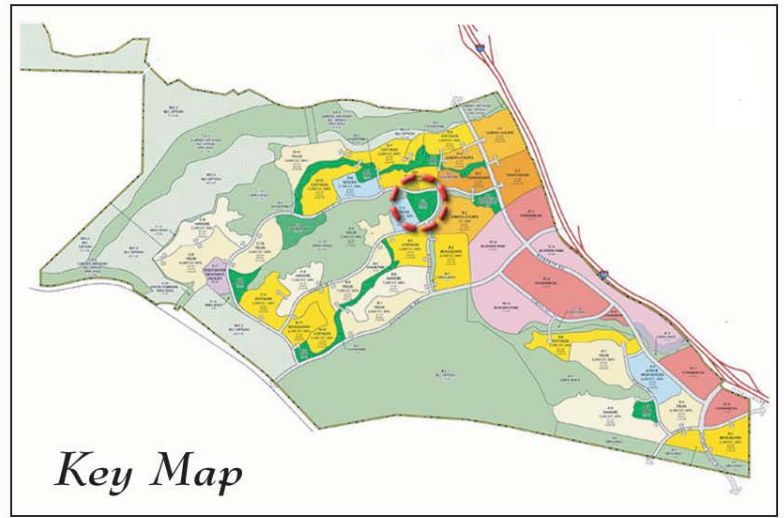

Key Map

SUMMERWIND RANCH AT OAK VALLEY

Specific Plan Area No. 1,
Amendment No. 1



FIGURE IV-58

Active Park C



Legend

Symbol	Description
	Large canopy tree
	Ornamental / shade tree
	Residential lot
	Slope treatment
	Shrub planting
	Turf
	Asphalt
	Trail Head Monument

Description

Design Guidelines

Active Park D shall be a joint use park with the adjacent school. The park should have a soccer field, basketball courts, volleyball pit and separate tot lots for children of age groups 2-5 and 5-12. The park should have ample parking and connections to the community paseo.

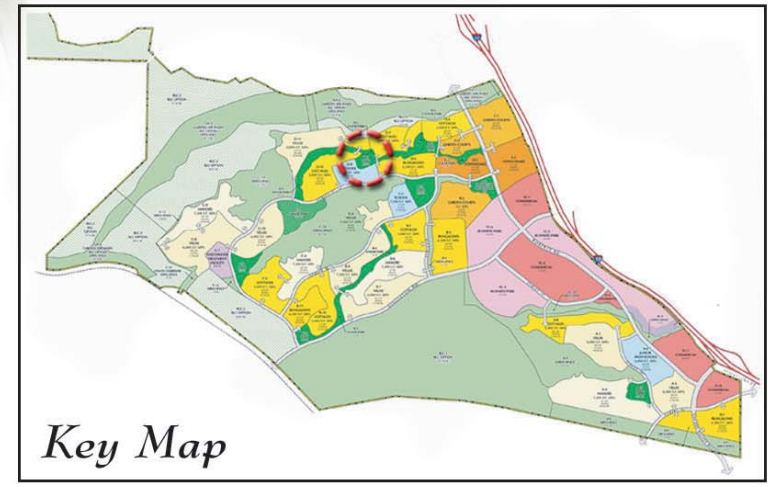

SUMMERWIND RANCH AT OAK VALLEY

Specific Plan Area No. 1,
Amendment No. 1





Legend

Symbol	Description
	Large canopy tree
	Ornamental / shade tree
	Residential lot
	Preserved Riparian Corridor
	Shrub planting
	Turf
	Asphalt
	Trail Head Monument

Description

Design Guidelines

This active park will connect to the phase 1 linear park, tying into the community trail system. Existing open space on the southern portion of the site will be preserved. The site amenities shall include one basketball court, a softball field, tot lots accommodating kids of all ages, and ample picnic and passive use areas.

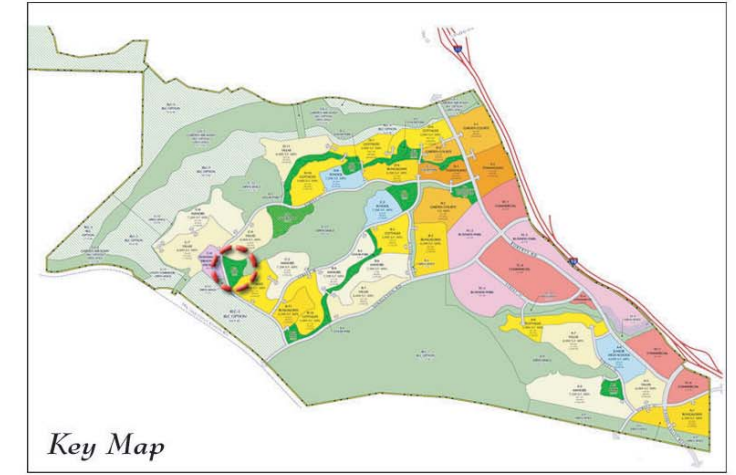

SUMMERWIND RANCH AT OAK VALLEY

Specific Plan Area No. 1,
Amendment No. 1



FIGURE IV-59a

Active Park E



Legend

Symbol	Description
	Large canopy tree
	Ornamental / shade tree
	Oak tree
	Residential lot
	Slope treatment
	Non-Irrigated Meadow
	Shrub planting
	Asphalt
	Trail Head Monument

Description

Design Guidelines

The nature park shall be a drought resistant, wildlife oasis. Educational gardens and informational signs will be located throughout. There should be an ADA accessible trail system throughout the park, linking educational overlooks, nodes and the community trail system.

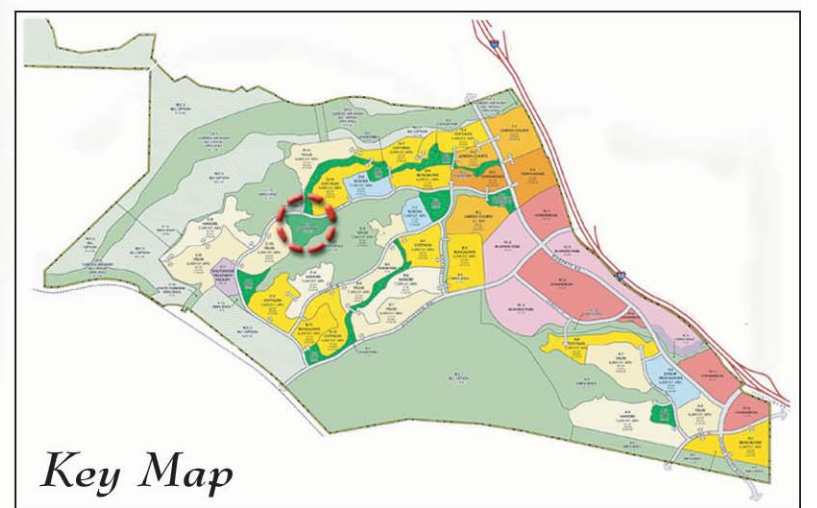

SUMMERWIND RANCH AT OAK VALLEY

Specific Plan Area No. 1,
Amendment No. 1



❑ **Passive Parks**

Passive Parks are made up primarily of an open play lawn area with other small added features such as a tot lot or sidewalks and benches within the park. This is shown in Figure 4-61, *Passive Park – Phase 2*.

❑ **Linear Parks**

Linear Parks create a linkage throughout the project site for the recreational uses. The entire linear park system and examples of linear pockets can be found in Figure 4-62, *Linear Park – Concept*; Figure 4-63, *Linear Park – Pocket 1*; Figure 4-64, *Linear Park – Pocket 2*; Figure 4-65, *Linear Park – Pocket 3*; Figure 4-66, *Linear Park – Phase 3 Concept*; and Figure 4-67, *Linear Park – Passive*.

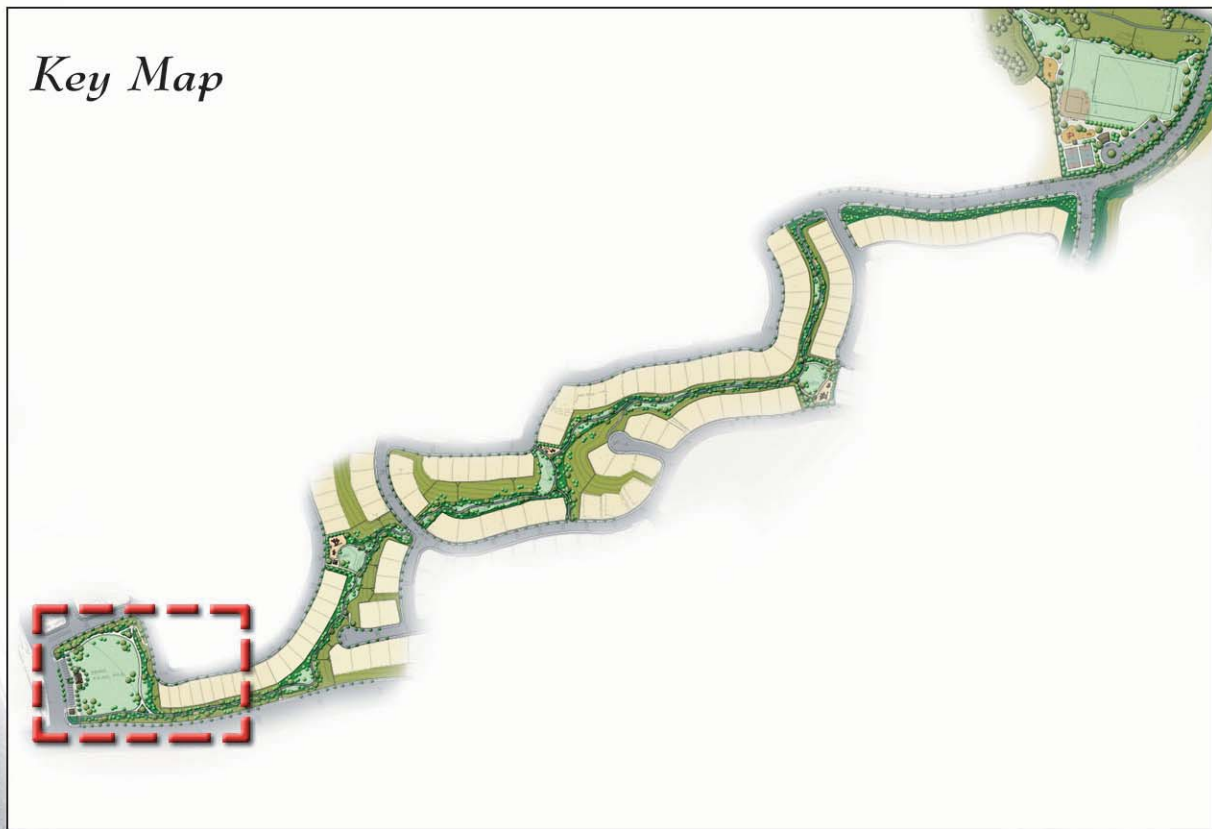

Legend

Symbol	Description
	Large canopy tree
	Ornamental / shade tree
	Residential lot
	Slope Treatment
	Shrub planting
	Turf
	Asphalt
	Trail Head Monument

Description

Design Guidelines

Located nearest the minor entrance to the community, this park will act as the starting point to the phase 2 linear park. The par course, which will continue throughout the community parks and trail system, will start in this park. The park will primarily be of passive uses, a grand lawn area is surrounded by more vegetated picnic areas.



SUMMERWIND RANCH AT OAK VALLEY

Specific Plan Area No. 1,
Amendment No. 1



FIGURE IV-61

Passive Park - Phase 2

PAGE IV-101

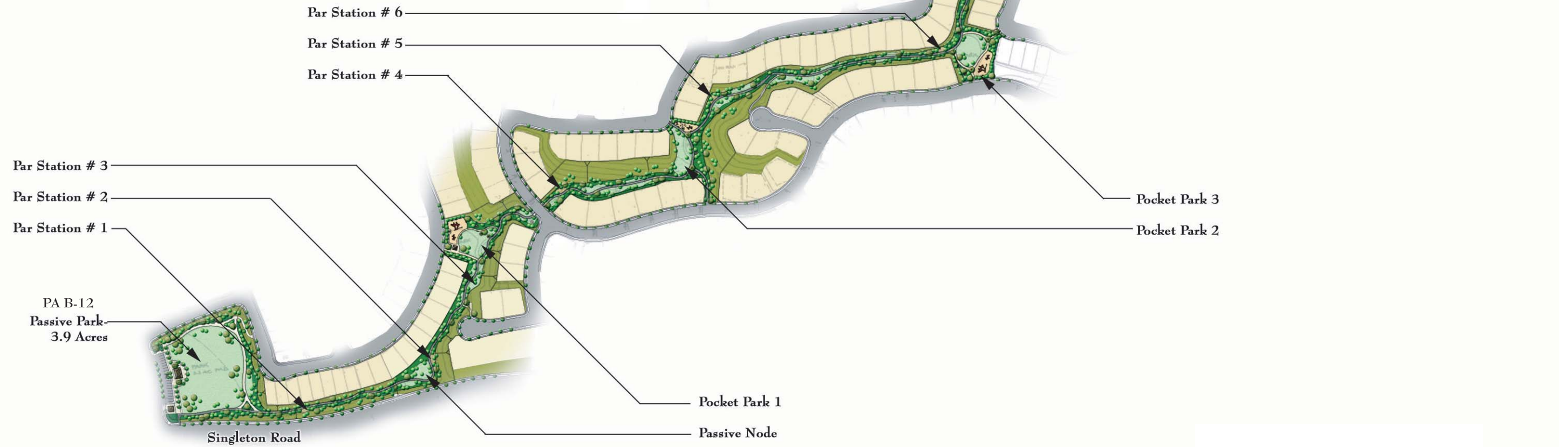
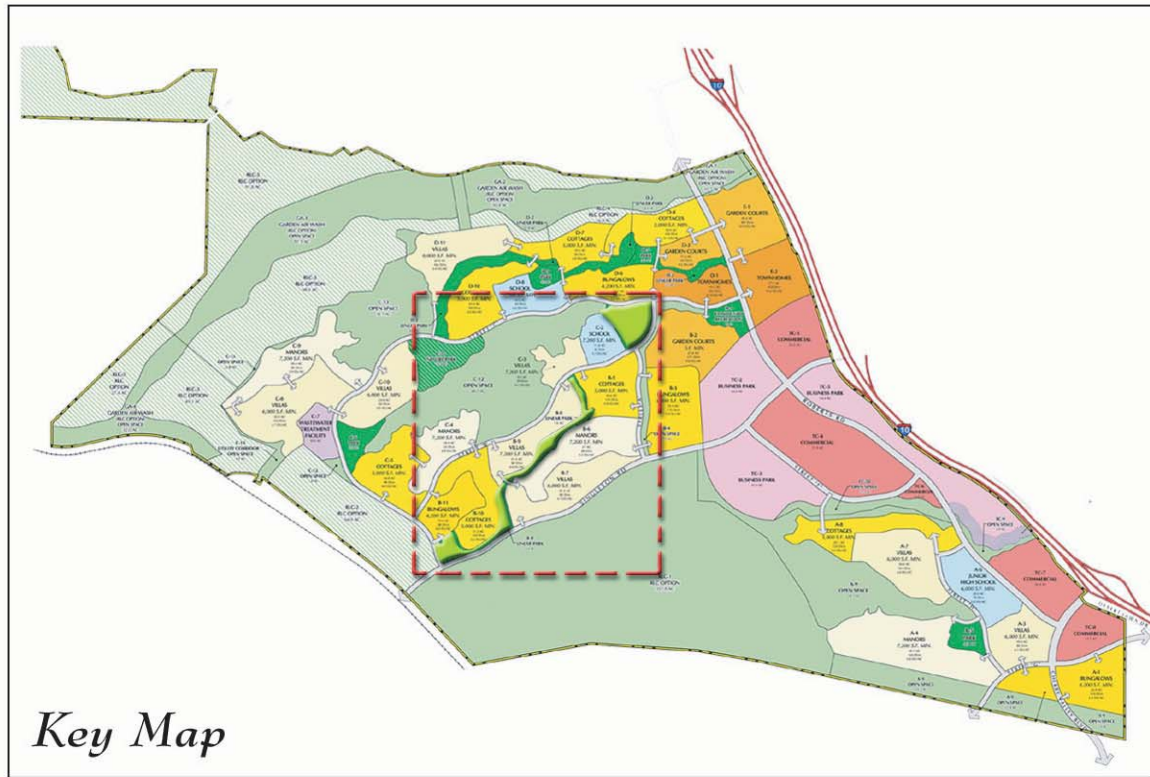

SUMMERWIND RANCH AT OAK VALLEY

Specific Plan Area No. 1,
Amendment No. 1



Key Map

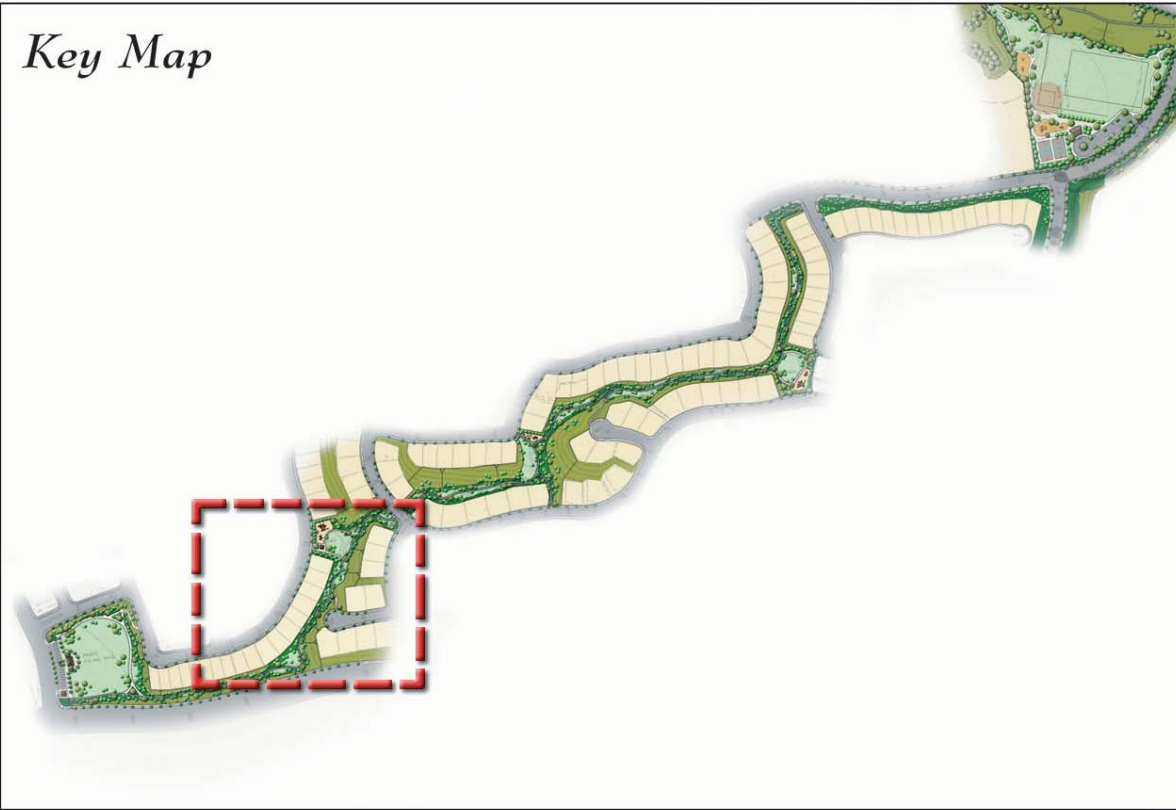

Legend

Symbol	Description
	Large canopy tree
	Ornamental / shade tree
	Residential lot
	Slope treatment
	Shrub planting
	Turf
	Asphalt
	Trail Head Monument

Description

Design Guidelines

As the linear park meanders through the community, there shall be open lawn areas where feasible, par course stations, and picnic areas. Pocket parks should have tot lots, passive areas and shaded picnic areas. Tot lots shall be screened by vegetation and soundwalls when adjacent to residential lots. Tot lots should be ADA compliant and have ample shaded seating areas. Trail monumentation shall be placed at junctions, and paseo circulation shall not interfere with park recreation. Parks and park pathways shall be ADA compliant.

SUMMERWIND RANCH AT OAK VALLEY

Specific Plan Area No. 1,
Amendment No. 1



Key Map

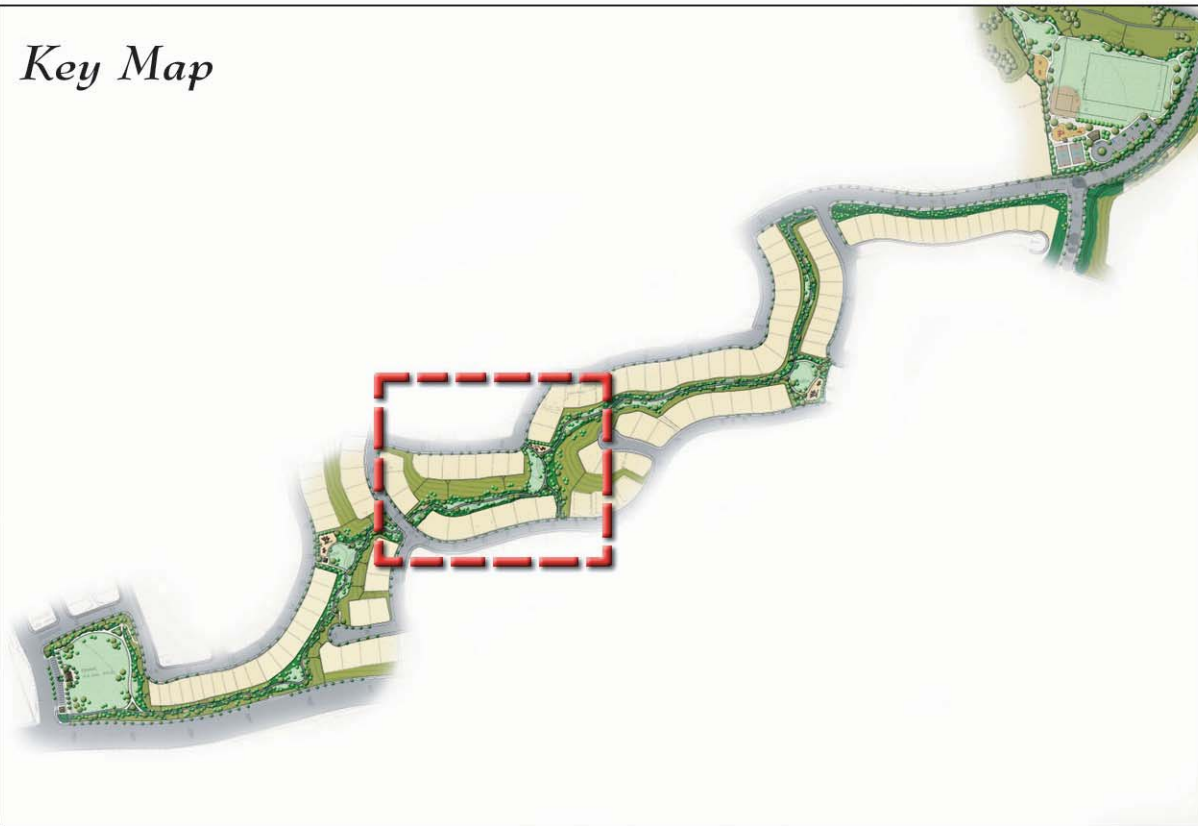

Legend

Symbol	Description
	Large canopy tree
	Ornamental / shade tree
	Residential lot
	Slope treatment
	Shrub planting
	Turf
	Asphalt
	Trail Head Monument

Description

Design Guidelines

As the linear park meanders through the community, there shall be open lawn areas where feasible, par course stations, and picnic areas. Pocket parks should have tot lots, passive areas and shaded picnic areas. Tot lots shall be screened by vegetation and soundwalls when adjacent to residential lots. Tot lots should be ADA compliant and have ample shaded seating areas. Trail monumentation shall be placed at junctions, and paseo circulation shall not interfere with park recreation. Parks and park pathways shall be ADA compliant.



SUMMERWIND RANCH AT OAK VALLEY

Specific Plan Area No. 1,
Amendment No. 1

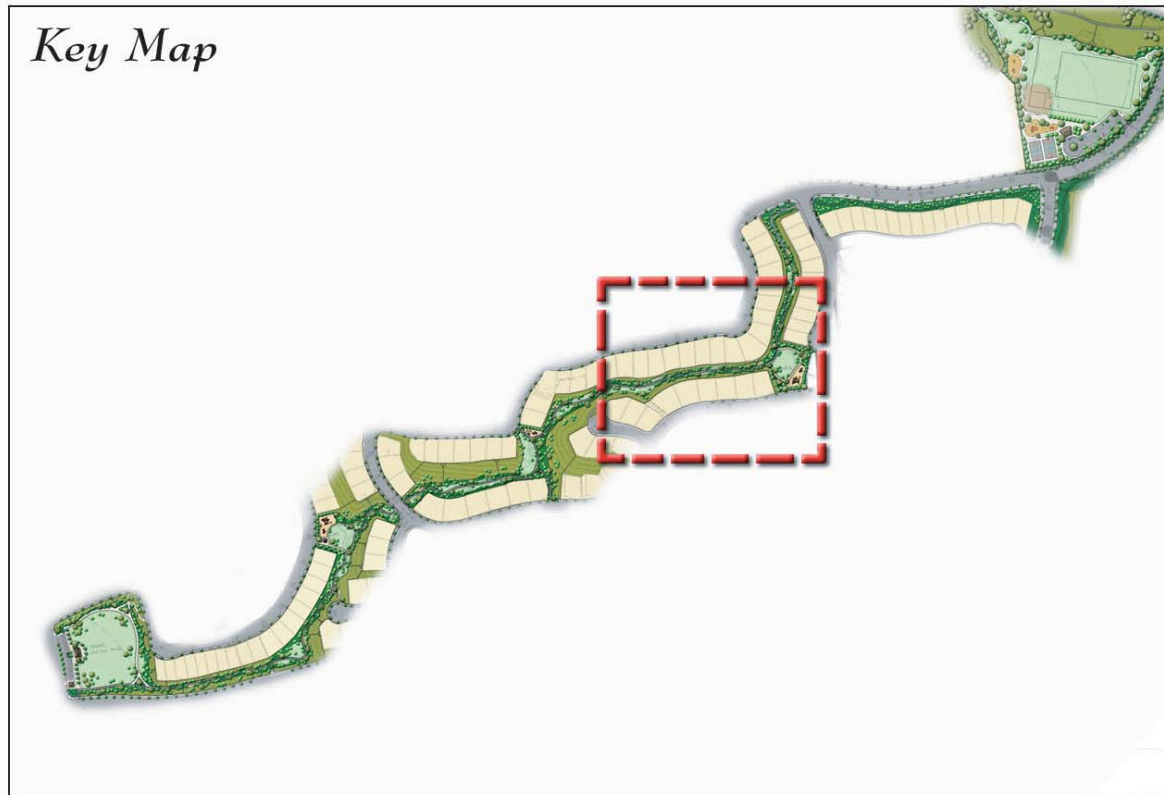

FIGURE IV-64

Linear Park - Pocket 2

PAGE IV-104

Key Map



Legend

Symbol	Description
	Large canopy tree
	Ornamental / shade tree
	Residential lot
	Slope treatment
	Shrub planting
	Turf
	Asphalt
	Trail Head Monument

Description

Design Guidelines

As the linear park meanders through the community, there shall be open lawn areas where feasible, par course stations, and picnic areas. Pocket parks should have tot lots, passive areas and shaded picnic areas. Tot lots shall be screened by vegetation and soundwalls when adjacent to residential lots. Tot lots should be ADA compliant and have ample shaded seating areas. Trail monumentation shall be placed at junctions, and paseo circulation shall not interfere with park recreation. Parks and park pathways shall be ADA compliant.

SUMMERWIND RANCH AT OAK VALLEY

Specific Plan Area No. 1,
Amendment No. 1



FIGURE IV-65

Linear Park - Pocket 3

PAGE IV-105

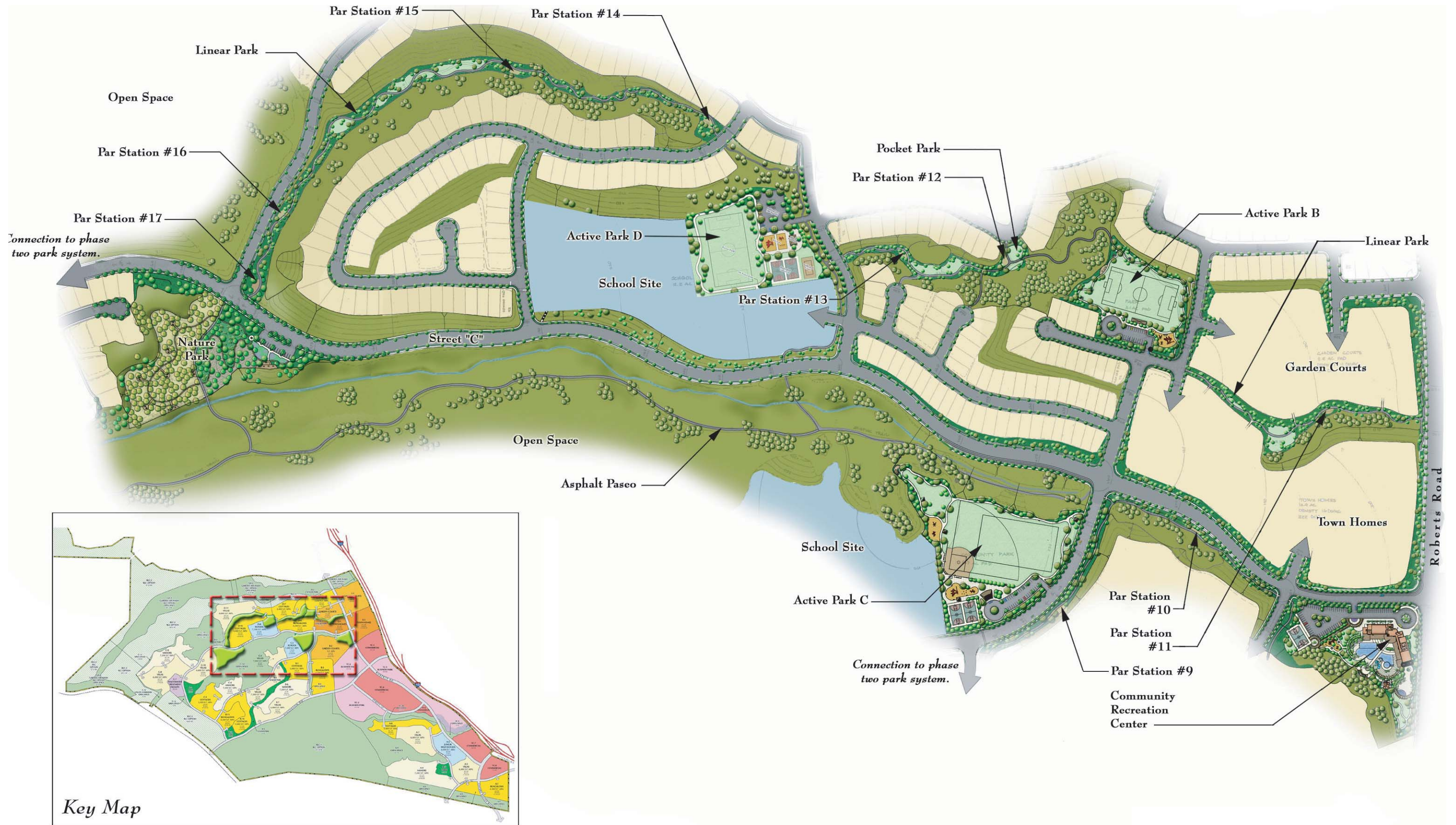

SUMMERWIND RANCH AT OAK VALLEY

Specific Plan Area No. 1,
Amendment No. 1



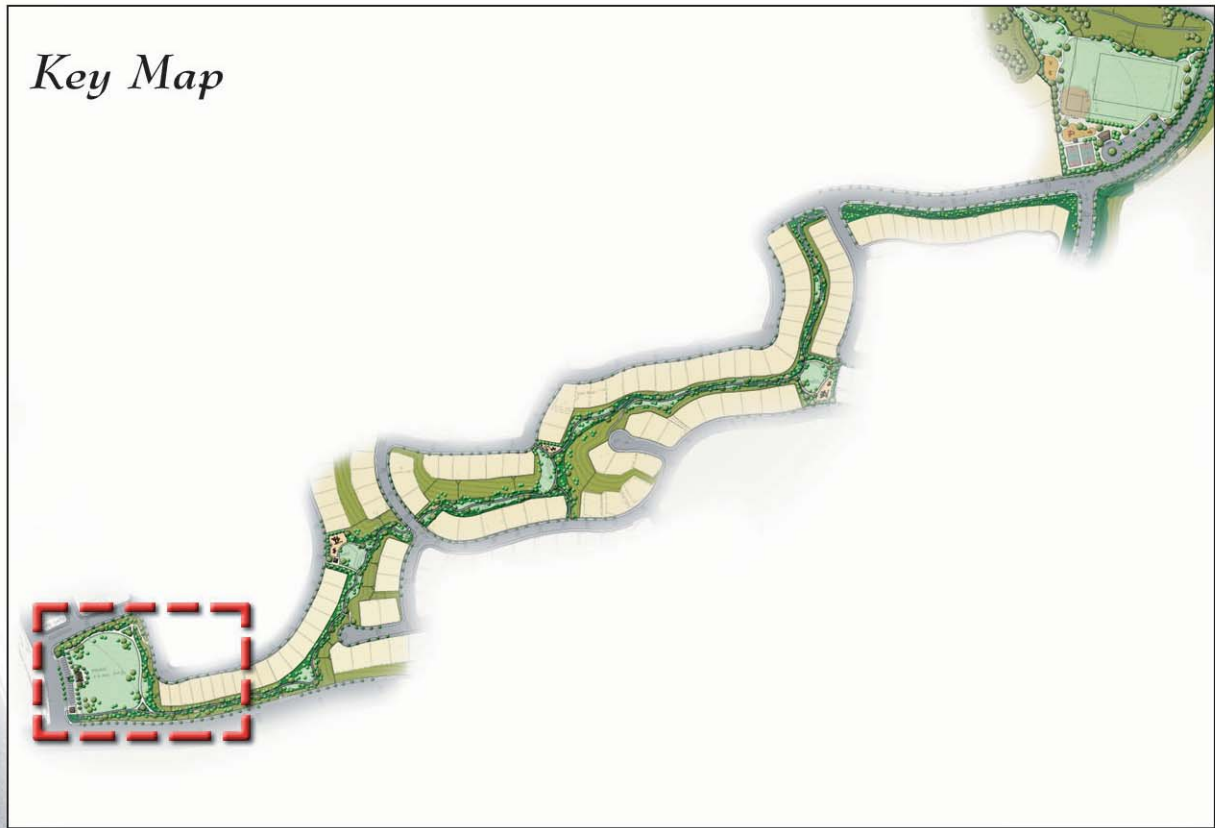

Legend

Symbol	Description
	Large canopy tree
	Ornamental / shade tree
	Residential lot
	Slope Treatment
	Shrub planting
	Turf
	Asphalt
	Trail Head Monument

Description

Design Guidelines

Located nearest the minor entrance to the community, this park will act as the starting point to the phase 2 linear park. The par course, which will continue throughout the community parks and trail system, will start in this park. The park will primarily be of passive uses, a grand lawn area is surrounded by more vegetated picnic areas.



SUMMERWIND RANCH AT OAK VALLEY

Specific Plan Area No. 1,
Amendment No. 1



FIGURE IV-67

Linear Park - Passive

5. Trails and Sidewalks

The extensive trail multi-purpose trail system planned within the SUMMERWIND RANCH AT OAK VALLEY community is shown in Figure 4-68, *Trail and Sidewalk Plan*. An integrated network of pedestrian, bicycle, jogging, equestrian, and mountain biking trails promoting alternative modes of transportation are planned within the community. This trail system will also provide students with safe internal routes accessing schools, with minimal crossings at vehicular roadways. The planned trail system, in conjunction with neighborhood sidewalks, will give residents at SUMMERWIND RANCH AT OAK VALLEY an alternative to driving, allowing for safe and convenient access to the Town Center, schools, parks, and the abundant open space provided throughout the site.

Figures 4-69 through 4-75 illustrate the trail system, cross-sections of each trail type, roadway/trail interface cross-sections, trail overlooks, pedestrian bridge details, and trail details.

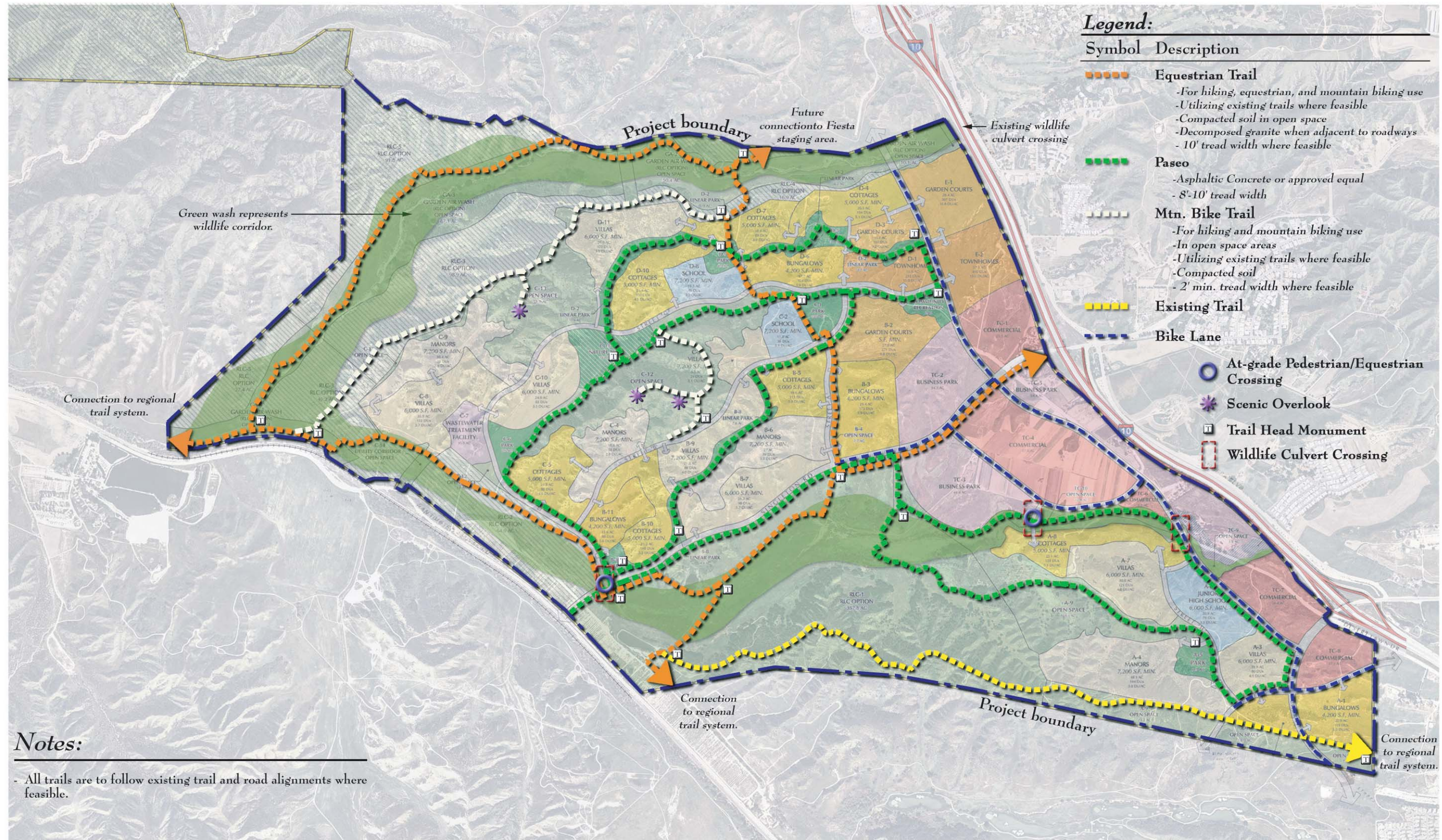

SUMMERWIND RANCH AT OAK VALLEY

Specific Plan Area No. 1,
Amendment No. 1



FIGURE IV-68

Trail and Sidewalk Plan

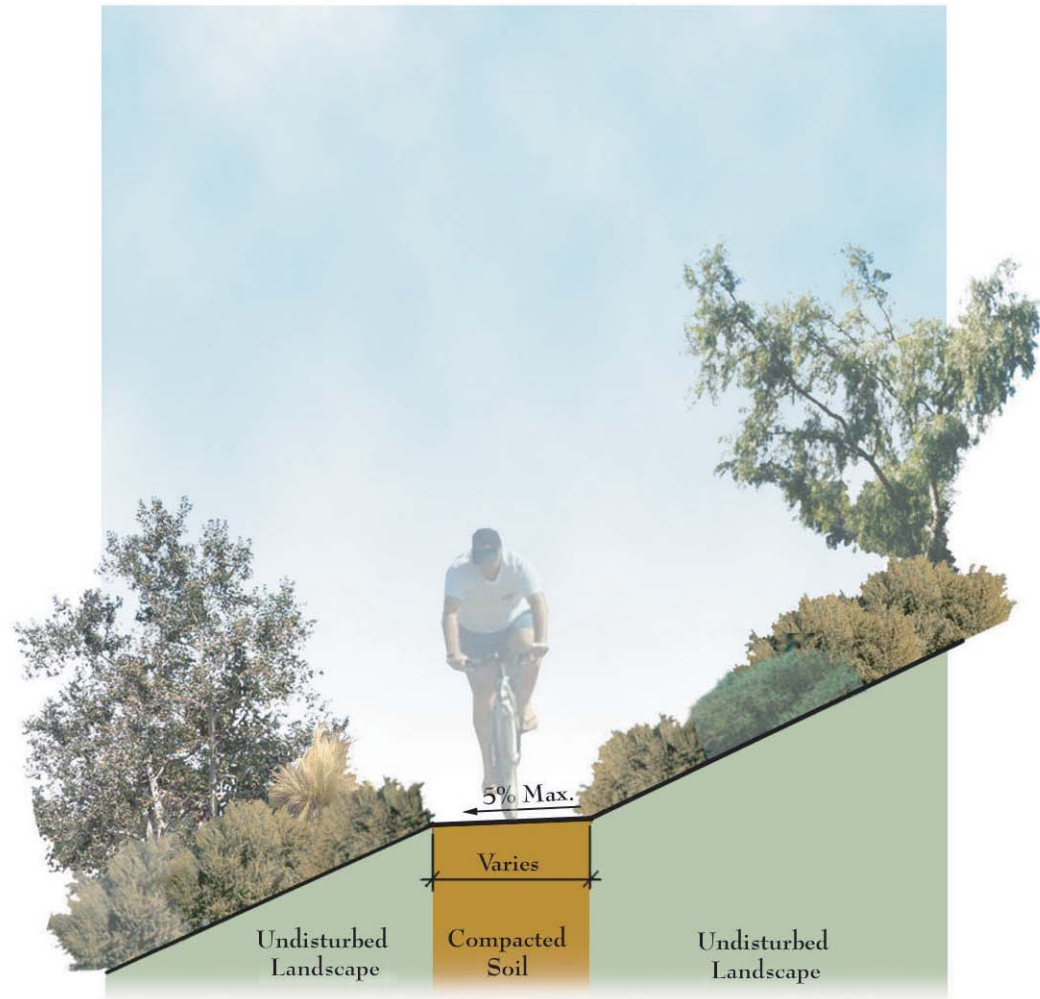

Mtn. Bike Trail

Design Guidelines:  (In Open Space Areas)

- For hiking and mountain biking use.
- Utilize existing trails where feasible.
- 24" tread width where feasible.
- Tread Obstacles - 2" Max.
- Trails shall be maintained by HOA.

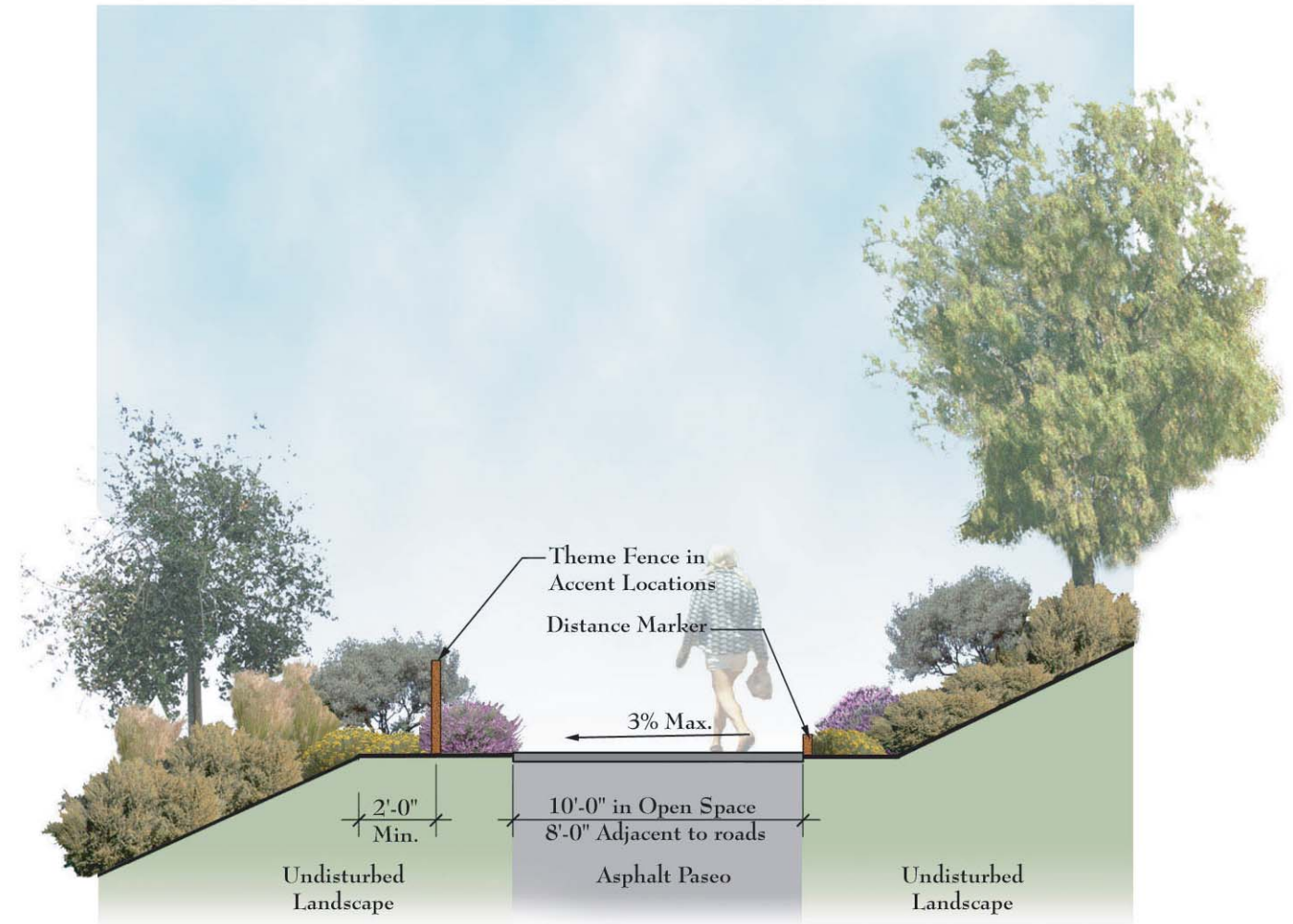

Paseo

Design Guidelines: 

- Design Grade to be 5%
 - Exception: 8% for 50', or 10% for 30'
- Trails shall be maintained by HOA.
- Theme fence at accent locations.
- Trail alignment and grade shall existing follow jeep trail where feasible.

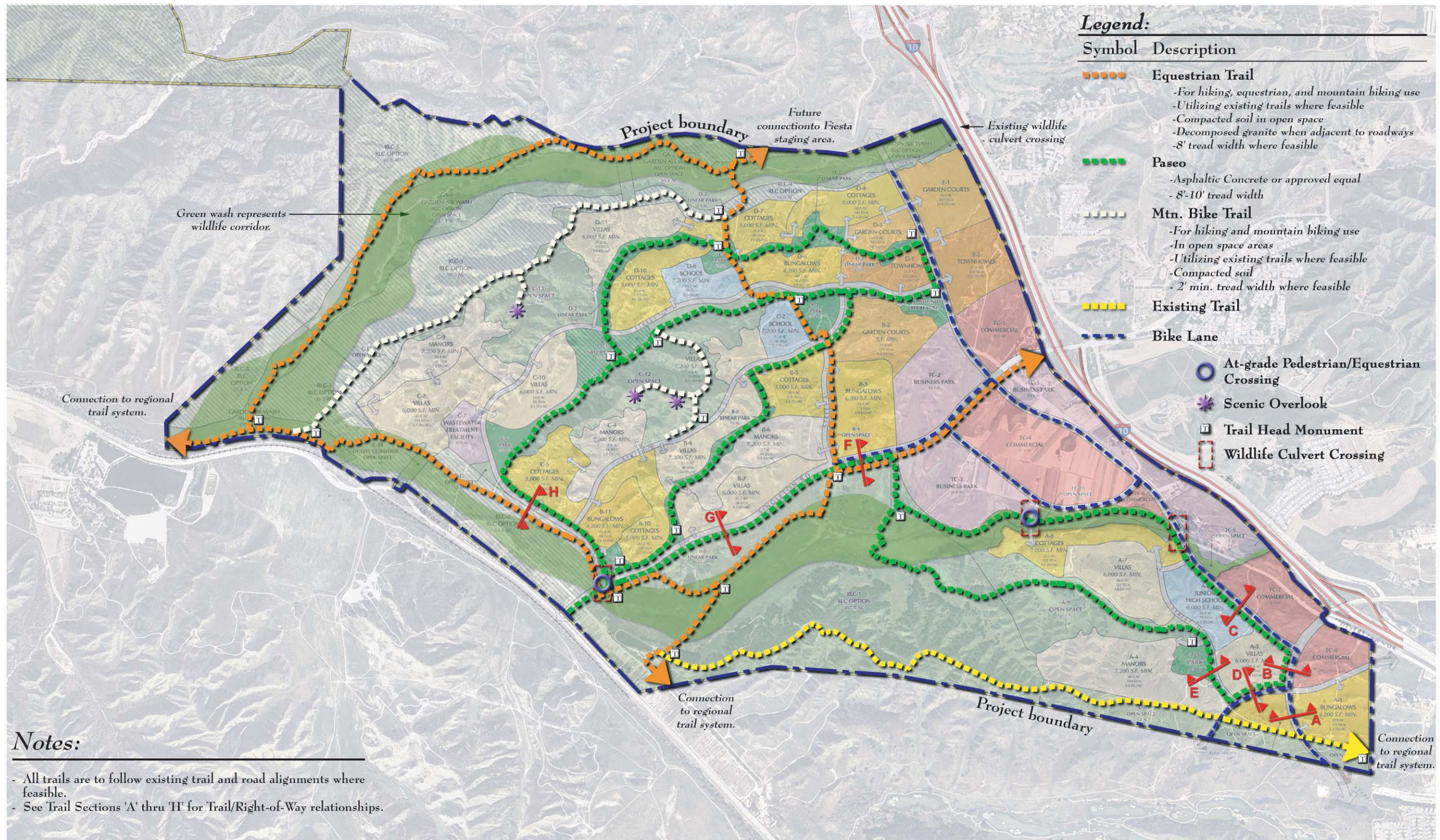

SUMMERWIND RANCH AT OAK VALLEY

Specific Plan Area No. 1,
Amendment No. 1



Figure 4-71 *Combined Roadway/Trail Interface Cross Sections A, B, C, & D*

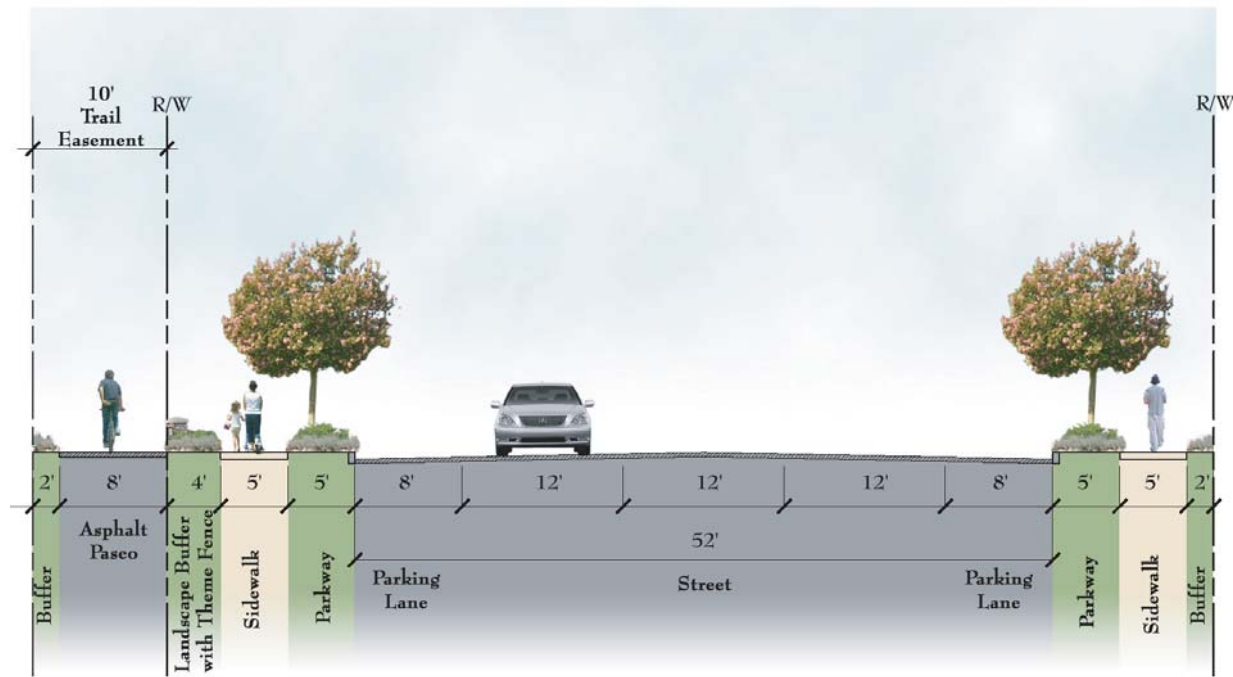

Trail Section 'E'

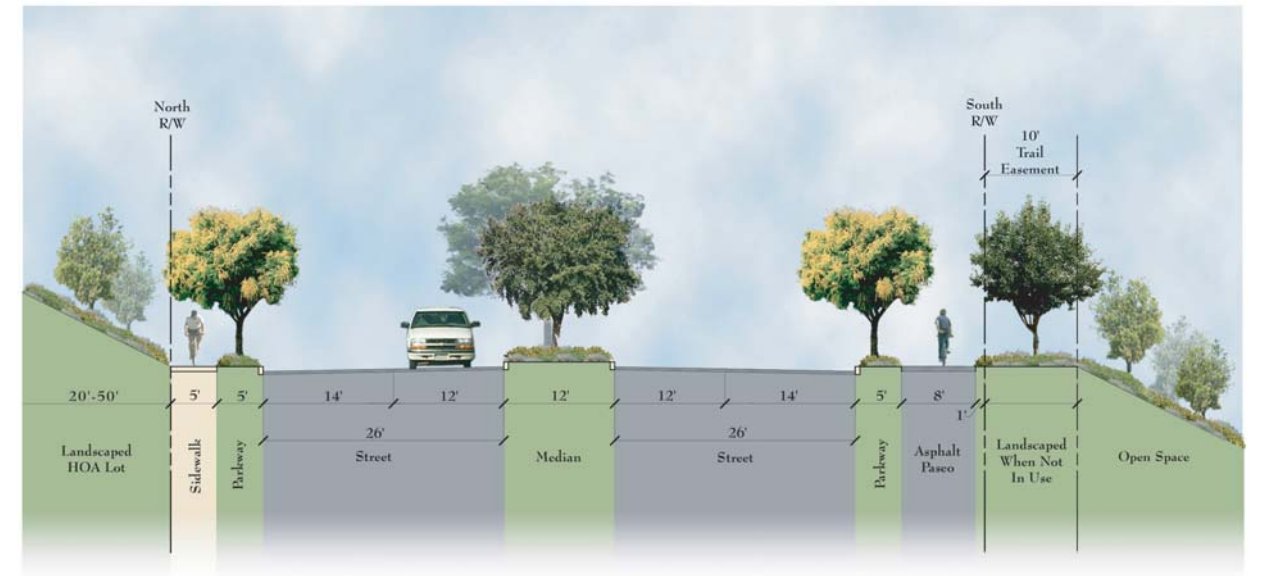

Trail Section 'G'

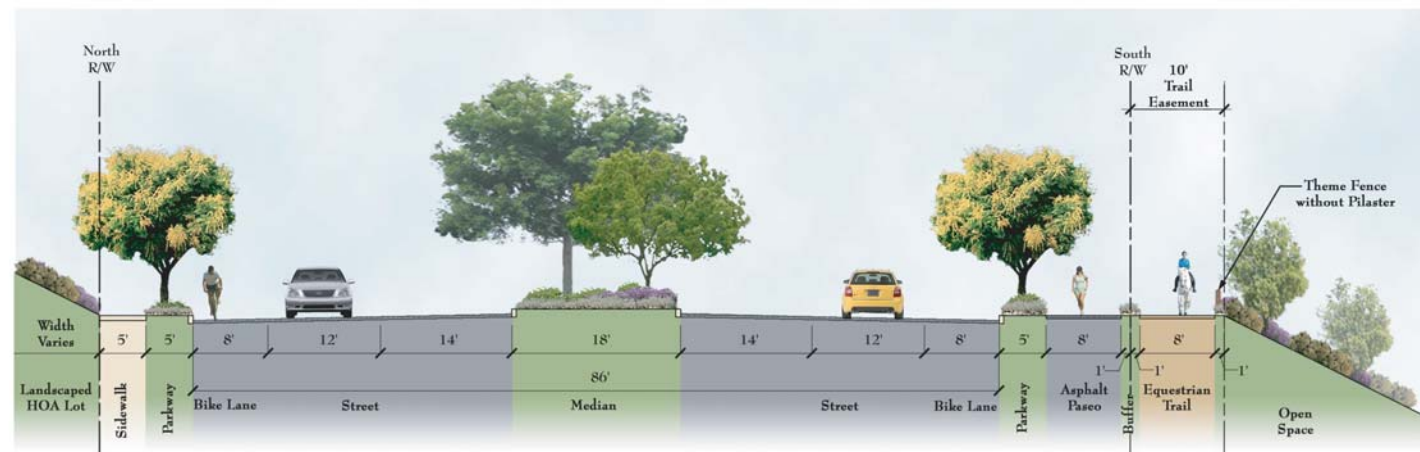

Trail Section 'F'

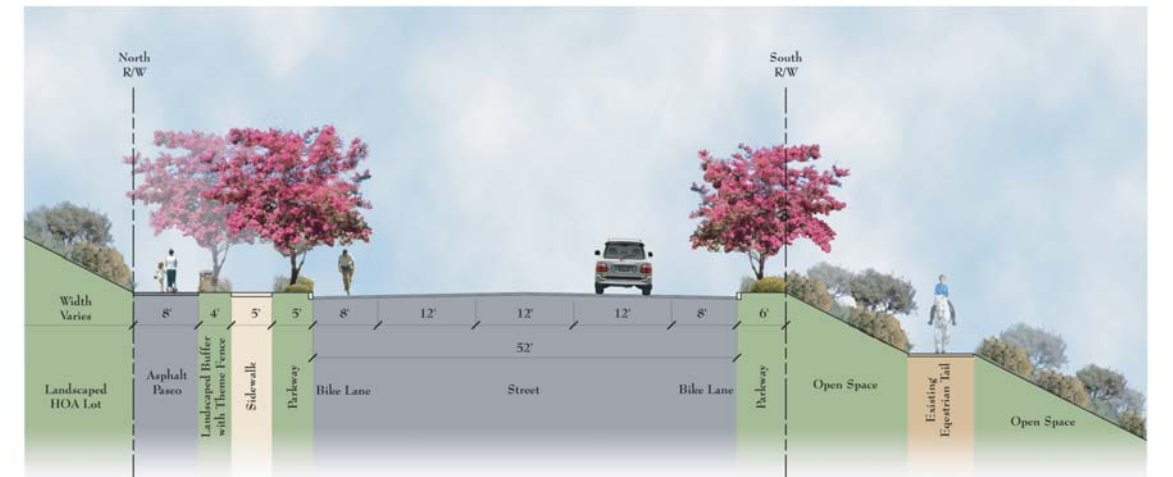

Trail Section 'H'

SUMMERWIND RANCH AT OAK VALLEY

Specific Plan Area No. 1,
Amendment No. 1



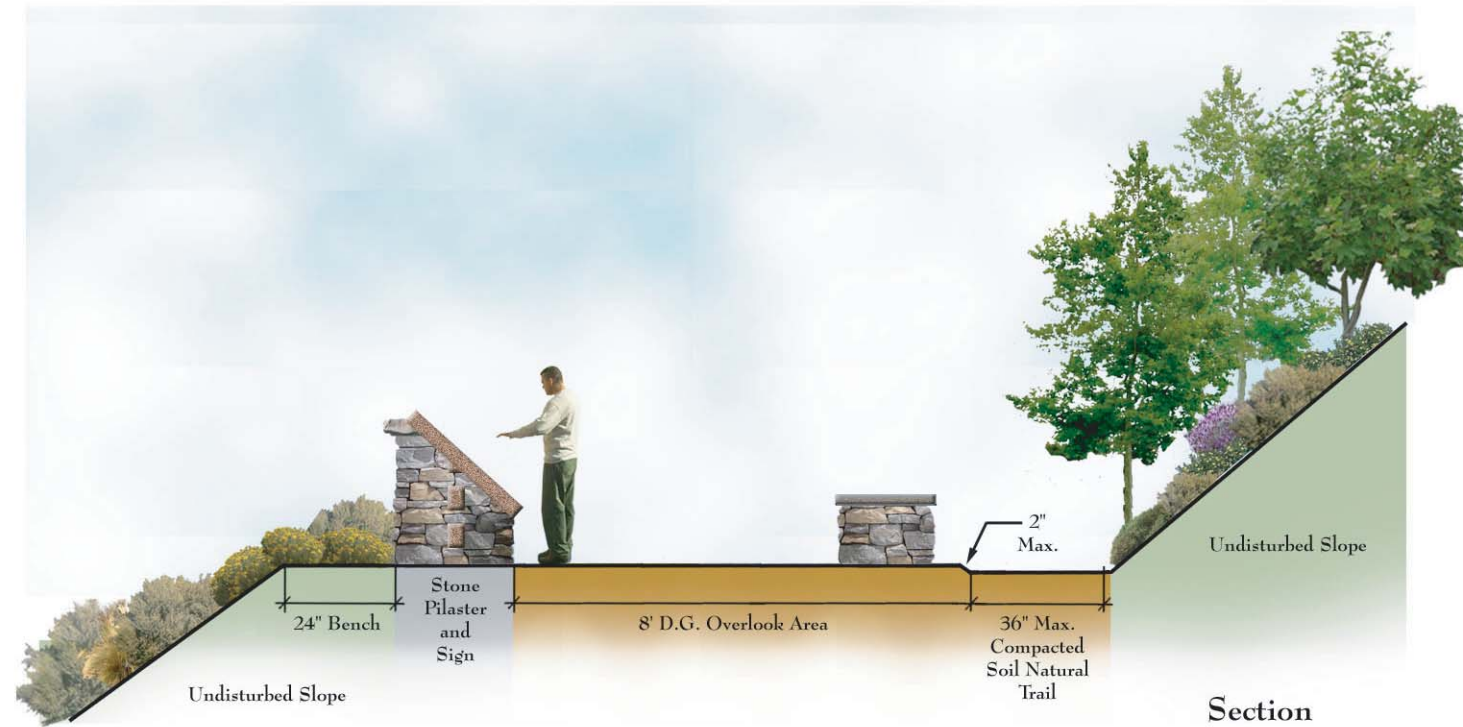

Pedestrian Overlook

Description: * (in open space areas)

- D.G. Overlook Area
- Pedestrian Benches
- Informational Signage
- All materials shall match surrounding environment and architecture.

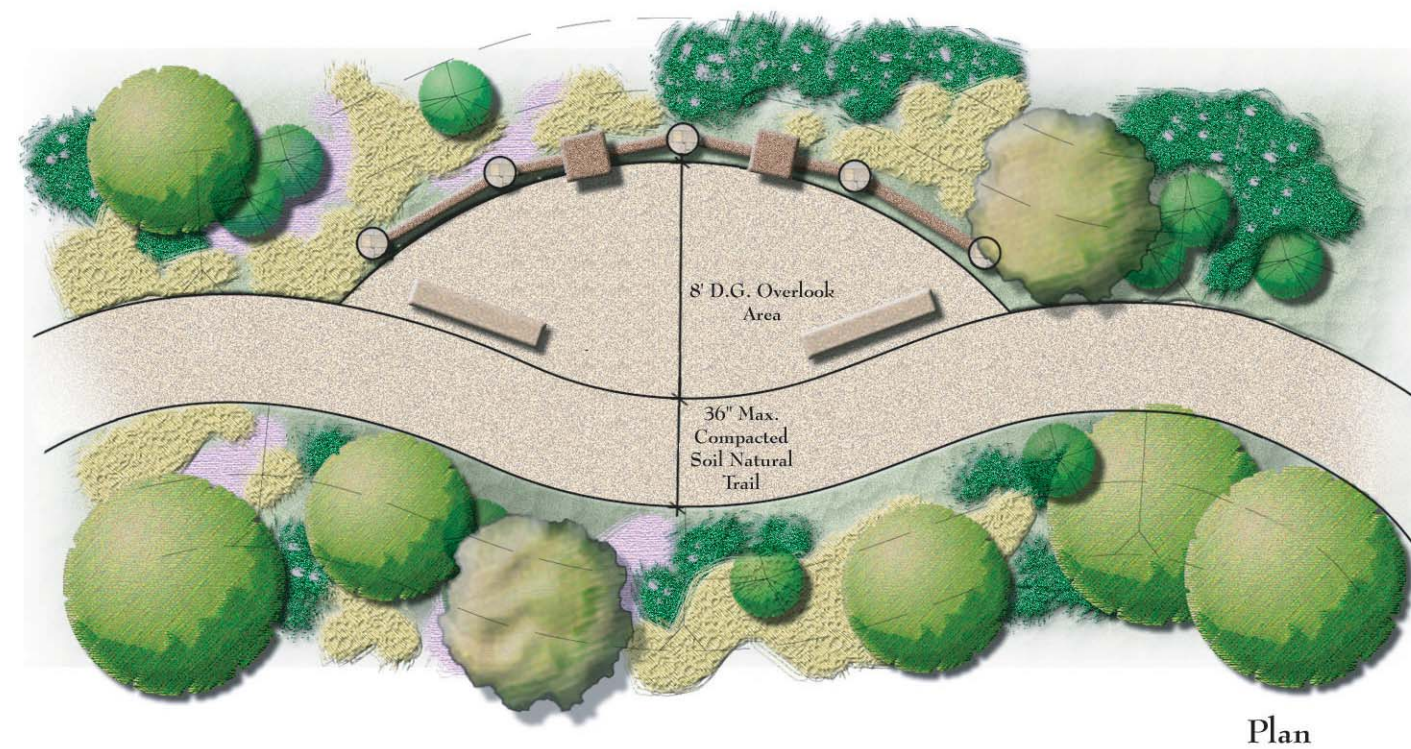

Locations

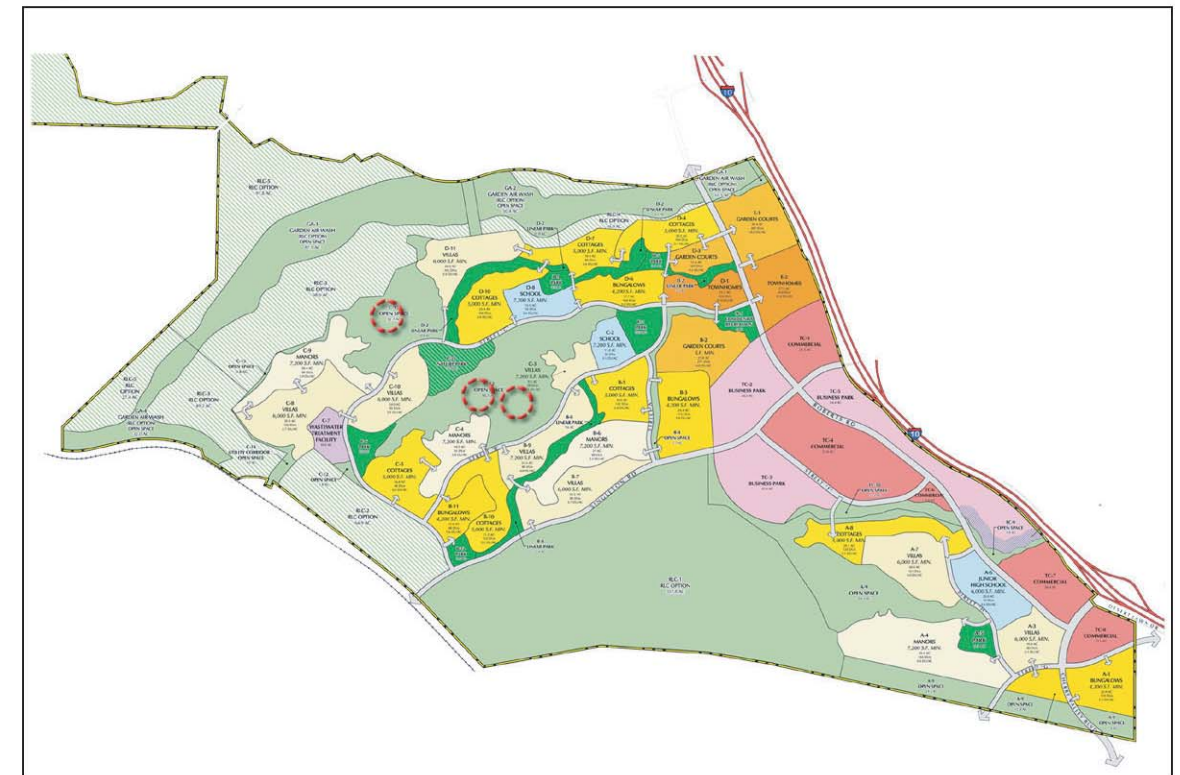

SUMMERWIND RANCH AT OAK VALLEY

Specific Plan Area No. 1,
Amendment No. 1



FIGURE IV-73

Pedestrian Trail Overlook

PAGE IV-114

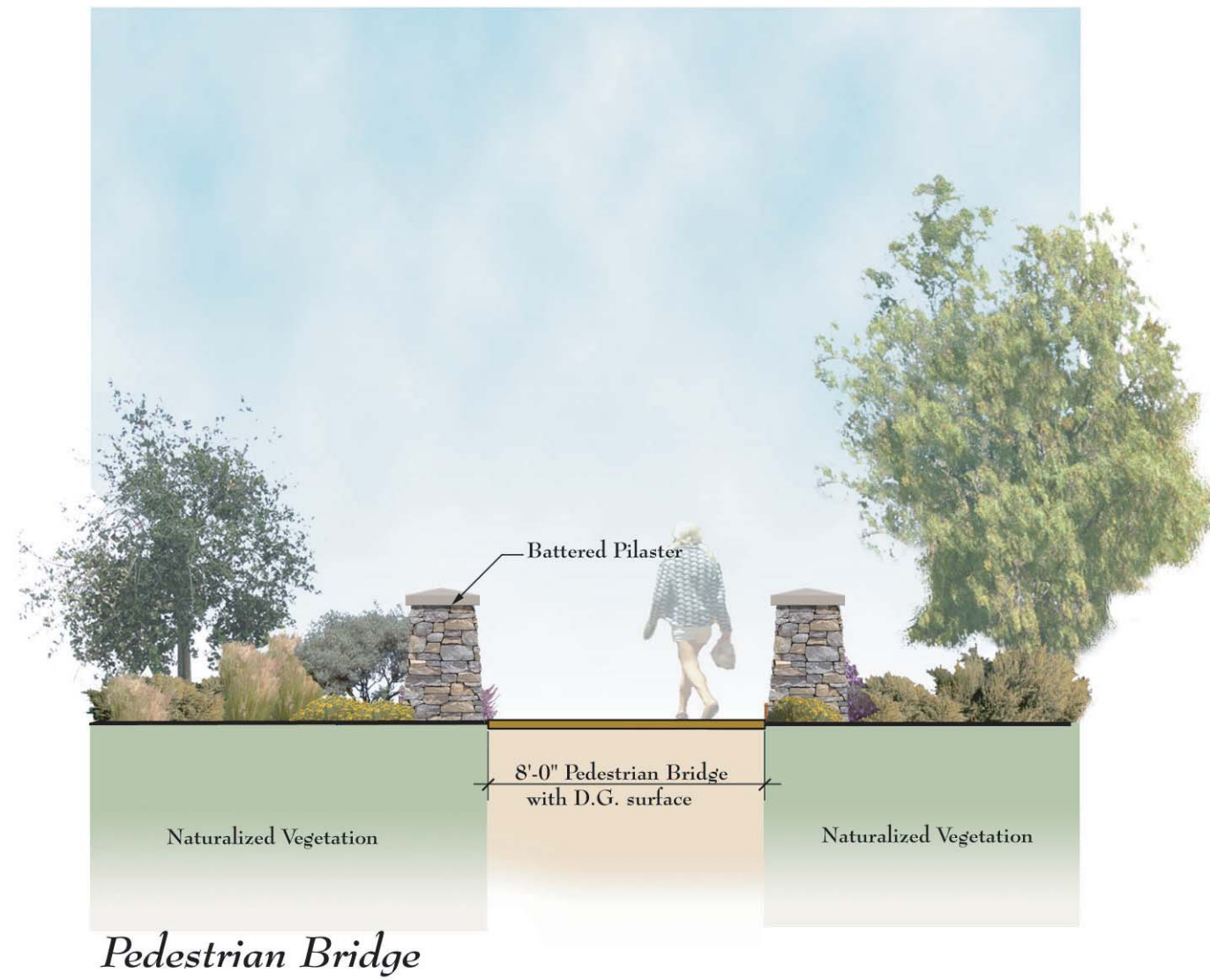

SUMMERWIND RANCH AT OAK VALLEY

Specific Plan Area No. 1,
Amendment No. 1





Equestrian Trail

Design Guidelines:  *(In Open Space Areas)*

- For hiking, equestrian, and mountain biking use.
- Utilizing existing trails where feasible.
- 8' tread width where feasible.
- Trails shall be curvilinear aligned (crossing contour lines at flat or oblique angles.)
- Trails shall connect with existing regional trail systems when possible.
- Trails shall be maintained by HOA.

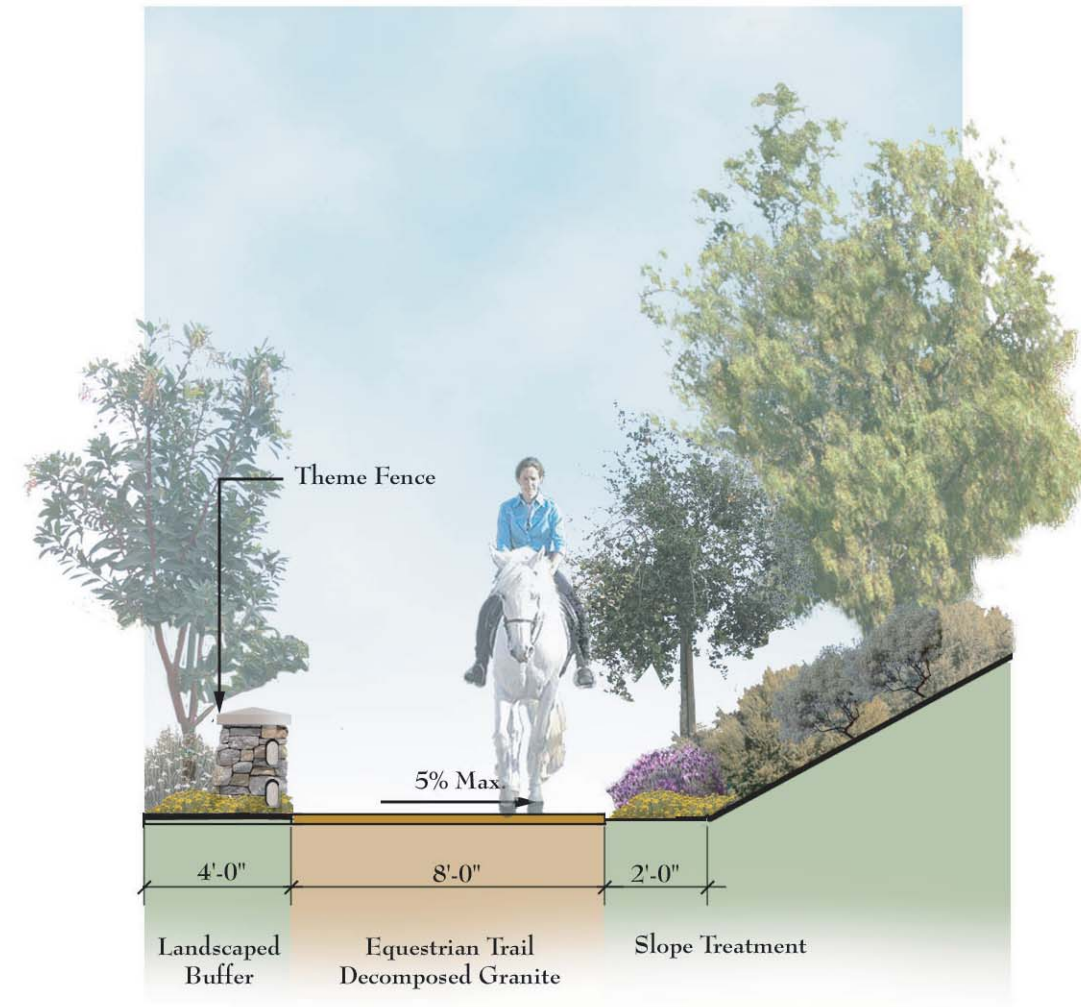

Equestrian Trail

Design Guidelines:  *(Along Roadways)*

- Trail grade to follow street grade.
- Trail surface shall be a minimum of 3" thick decomposed granite, flush with adjacent finished grade.
- Theme fence at accent locations.
- Trails shall be maintained by HOA.

F. Landscape Design Guidelines

1. General Landscape Design Issues

The proposed landscape character will be expressed throughout the community open spaces including streetscapes, community entries, an extensive linear park system and manufactured and transitional slopes. The landscape concept plan features generous landscape setbacks enhancing community streetscenes, an interior paseo network and streetscene trail system, and an extensive recreation amenity package. In addition, the landscape development transitions and buffers on-site development and open space use areas. These community landscape elements will provide an overall continuity to the project. The landscape development concept will reinforce and remain sensitive to the established rural character of the site and existing environs. When feasible, existing and established (mature and healthy) trees shall be preserved or relocated into the project landscape design. General landscape issues will be presented including things such as drought tolerance, planting time, climate constraints, irrigation standards, lighting and landscape maintenance standards. The landscape guidelines are intended to complement the architectural and site planning guidelines and achieve a harmonious, consistent community image reinforcing the overall SUMMERWIND RANCH AT OAK VALLEY setting.

2. Outdoor Lighting

A master plan for street lighting and monumentation accent lighting will be created at the tentative map level for each phase of the project and coordinated with the appropriate governing agencies. All streets and commercial developments in SUMMERWIND RANCH AT OAK VALLEY shall have uniform lighting standards with regard to style, materials, and colors in order to ensure consistent design. Each residential development may develop its own lighting standards, provided that the selected lighting fixture style is used consistently throughout the project. Lighting fixtures shall be well integrated into the visual environment and the appropriate architectural theme.

3. Signage

For conceptual thematic signage and monumentation refer to previous figures within this specific plan. Ultimate signage and monumentation locations will be established during the tentative map process as grading and lot configuration begins to be more precise. Within the tentative map process, lot configuration related to monument features and special signage will be coordinated with the appropriate governing agencies.

4. Mailboxes

Once construction documents are underway, a mailbox master plan will be created and coordinated with the United States Postal Service, identifying type and location of mailbox structures.

5. Irrigation

Irrigation Point of Connection Master Plans will begin to be created during the tentative map process as grading, lot configuration and maintenance responsibility begins to be more precise and will act as coordination mechanisms between the landscape architect, civil engineer, dry utility consultant, utility provider, and water district through the construction document process.

All common irrigation areas shall be capable of being operated by a computerized irrigation system which includes an onsite weather station/ET gage capable of reading current weather data and making automatic adjustments to independent program run times for each irrigation valve based on changes in temperature, solar radiation, relative humidity, rain and wind. In addition, the computerized irrigation system shall be equipped with flow sensing capabilities, thus automatically shutting down the irrigation system in the event of a mainline break or broken head. These features will assist in conserving water, eliminating the potential of slope failures due to mainline breaks and eliminating over watering and flooding due to pipe and/or head breaks.

All landscaped areas shall be watered with a permanent underground irrigation system.

6. Erosion Control

Grading will be phased so that revegetation or construction will control erosion. Revegetated slopes will consist of two primary types: permanently irrigated interior slopes and exterior slopes utilizing natural slope restoration.

Permanently Irrigated Interior Slopes: Permanently Irrigated Interior Slopes consist of manufactured slopes 3' feet or greater that are not adjacent to open space that face other built architectural elements and/or streets. These manufactured slopes will utilize a permanent irrigation system to assist in plant development for slope stabilization. Plant material utilized in these areas may be any one or combination of irrigated hydroseeds, groundcovers, shrubs, vines and trees of ornamental or native character that compliments the overall community theme. Plants used on these slopes will be drought tolerant and fire retardant.

Exterior Slopes Utilizing Natural Slope Restoration: Exterior Slopes Utilizing Natural Slope Restoration techniques will be used on manufactured slopes 3' feet or greater that are directly adjacent to natural open space areas. These manufactured slopes will utilize a revegetation method that will not require either temporary, supplemental or permanent irrigation systems. The restoration process will include the grinding of native plant material that is removed from the site during initial grading operations and replanting of this ground up plant material by compacting it in a layered manner atop manufactured slopes, thus utilizing non-invasive native plant material that are indigenous to the area, sensitive to the surrounding environment and that utilizes natural ecological succession as a means to provide mature climax plant development that is integrated with the environmental surroundings. This method will require an increased period for developer maintenance to insure that restoration, revegetation and erosion control goals are met. Where possible, only those areas which will be built on, resurfaced or landscaped will be disturbed.

7. **Maintenance Responsibility**

Maintenance responsibility may consist of a variety of county, city and association types such as the Riverside Land Conservancy, County of Riverside MSCP districts, City of Calimesa Department of Parks and Recreation, City of Calimesa Public Works, lighting assessment districts, business', recreation and commercial associations as well as private homeowners-associations. Master Plans defining ultimate maintenance responsibility will be created more precisely, focusing on each phase during the tentative map process as grading and lot configuration begins to be more precise.

All landscape areas shall be maintained in accordance with the best industry standards for professional landscape maintenance. Such maintenance shall include watering, fertilization, mowing, edging, pruning, trimming, herbicide programming, pesticide programming, clean-up and other on-going seasonal programmed maintenance functions. Replacement of dead or diseased plant materials originally approved shall be accomplished on a routine basis. Irrigation systems shall be routinely inspected, repaired and maintained in an operating condition at all times. All walks shall be kept routinely free of litter and debris.

8. **Fuel Modification**

Fuel modification for SUMMERWIND RANCH AT OAK VALLEY complies with City of Calimesa Fuel Modification Standards, but is modified so that the irrigated zone lies within private lots rather than in native open space. This modified system insures maximum preservation of open space and environmental sensitivity while maximizing the safety of individual homeowner's. The fuel modification system, which is illustrated in Figure 4-76, *Fuel Modification Zones*, consists of the following zones:

□ **Zone A**

Shall be a permanently irrigated area installed by each individual private lot owner that is 15' setback from rear property line within private lot areas. Zone 'A' shall contain no habitable structures or structures that are directly attached to habitable structures or other combustible construction that provides a means for transmitting fire to the habitable structures. Structures such as hardscape, fences, walls and non-habitable gazebos that are located within this zone shall be constructed of non-combustible materials. Plants within Zone 'A' shall be primarily low growing and less than 4' in height with the exception of trees. Plants shall be low-fuel and fire resistive. Trees within Zone 'A' shall be located away from structures to a minimum distance of 10 feet as measured from the structures to the drip line of the tree at maturity. Zone 'A' shall be maintained by the individual private lot owner on a regular basis by pruning and thinning plants, controlling weeds and maintaining irrigation systems.

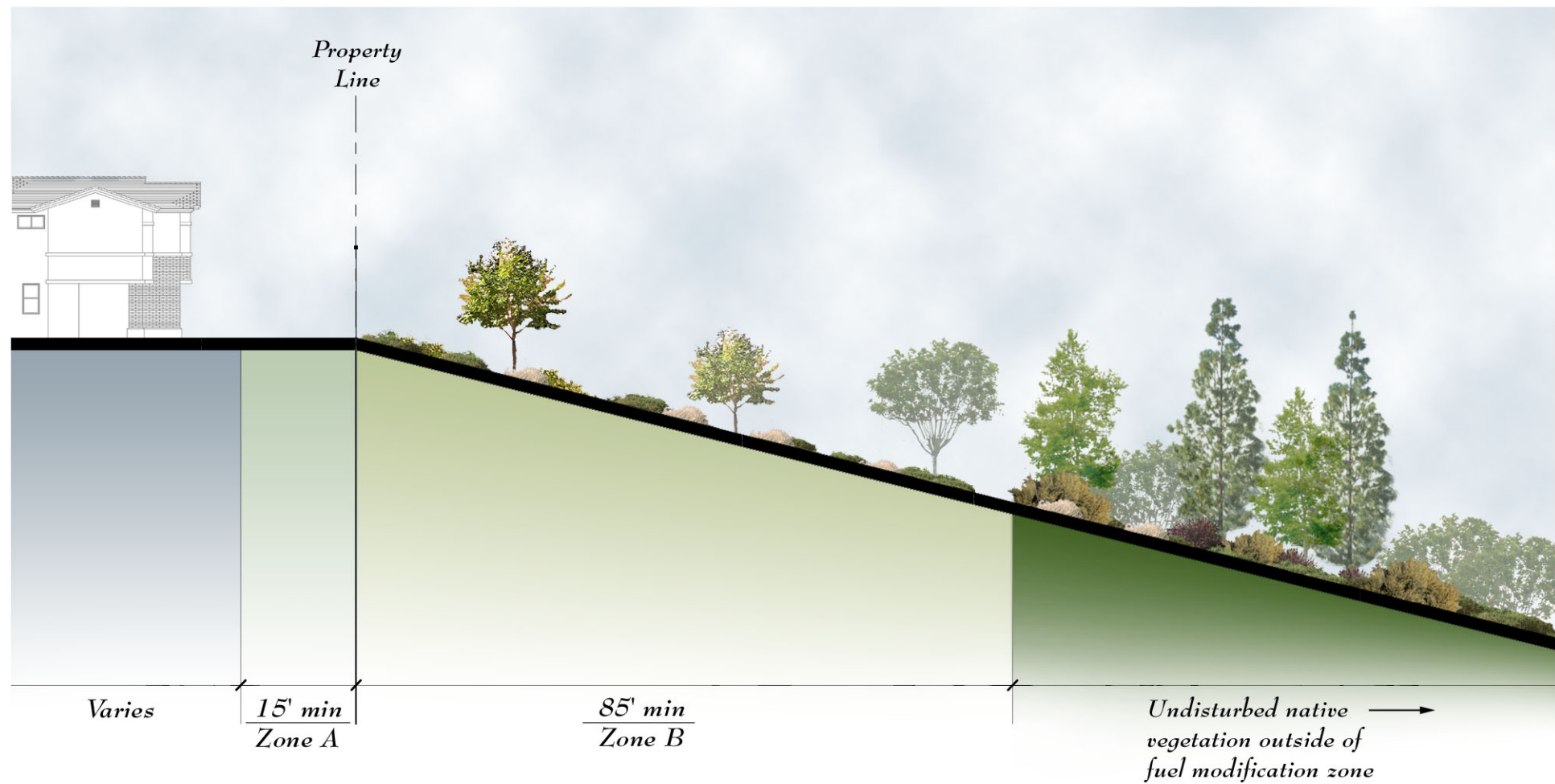

Notes:

1. All plant types and zone dimensions shall be approved by the Fire Department.
2. Lots which cannot accommodate the 15' setback requirement of Zone 'A' shall require a 1 hour rated fire wall.
3. Area limitations do not apply to large native tree species (*Quercus*, *Platanus*, *Populus*, etc.).

Fuel Modification Zoning

Descriptions:

- Zone A: (Irrigated Setback Zone) - 15' min.

Zone 'A' shall be a permanently irrigated area installed by each individual private lot owner that is 15' setback from rear property line within private lot areas. Zone 'A' shall contain no habitable structures, structures that are directly attached to habitable structures or other combustible construction that provides a means for transmitting fire to the habitable structures. Structures such as hardscape, fences, walls and non-habitable gazebos that are located within this zone shall be constructed of non-combustible materials. Plants within Zone 'A' shall be primarily low growing and less than 4' in height with the exception of trees. Plants shall be low-fuel and fire resistive. Trees within Zone 'A' shall be located away from structures to a minimum distance of 10 feet as measured from the structures to the drip line of the tree at maturity. Zone 'A' shall be maintained by the individual private lot owner on a regular basis by pruning and thinning plants, controlling weeds and maintaining irrigation systems.

- Zone B: (Low plantings or selective thinning) - 85' min.

Zone 'B' is a non-irrigated thinning zone measured as a 85' setback from the rear lot line into open space and consists of existing grasses and native vegetation thinned and pruned in the following manner:

- All dead and excessively twiggy growth removed.
- After pruning large trees and shrubs, low growing plants shall be separated by a distance three times their height from large plants.
- Trees and large shrubs pruned to provide clearance of three times the height of the understory plant material (or 6', whichever is higher).
- Debris and trimmings produced by thinning shall be removed from the site, or if left, shall be converted to mulch, and dispersed, non-irrigated, to a depth of 6".
- No native plants cut below 6".
- Individual non-irrigated groupings of plants over 18" in height may be retained provided

□ **Zone B**

Is an 85' non-irrigated thinning zone measured as a setback from the rear lot line into open space and consists of existing grasses and native vegetation thinned and pruned in the following manner:

- All dead and excessively twiggy growth removed.
- After pruning large trees and shrubs, low growing plants shall be separated by a distance three times their height from large plants.
- Trees and large shrubs pruned to provide clearance of three times the height of the understory plant materials (or 6', whichever is higher).
- Debris and trimmings produced by thinning shall be removed from the site, or if left, shall be converted to mulch, and dispersed, non-irrigated, to a maximum depth of 6".
- Individual non-irrigated groupings of plants over 18" in height may be retained provided they do not exceed 400 square feet in area and their combined coverage does not exceed 30% of the total Zone B area.

Areas where fuel modification is required are identified on Figure 4-77, *Fuel Modification Areas*. All plant types and zone dimensions shall be approved by the Fire Department. In areas where Zone 'B' encroaches on the existing Garden Air Wash, this zone may be modified as determined by the Fire Department. Lots that cannot accommodate the 15' setback requirement of Zone 'A' shall require a 1 hour rated fire wall. Area limitations do not apply to large native tree species (Quercus, Platanus, Populus, etc.) The fire department may modify the fuel modification requirements for individual lots on a case-by-case basis if the following conditions exist:

1. The modification to the requirements shall achieve an equivalent level of fire protection as provided by this section.
2. The modification to the requirements is not detrimental to the public health, safety and welfare of the persons residing or working in the area.

If the fire chief approves a modified plan in accordance with this section, as part of the City's approval of a development permit, the modifications shall be recorded with the approved permit conditions.

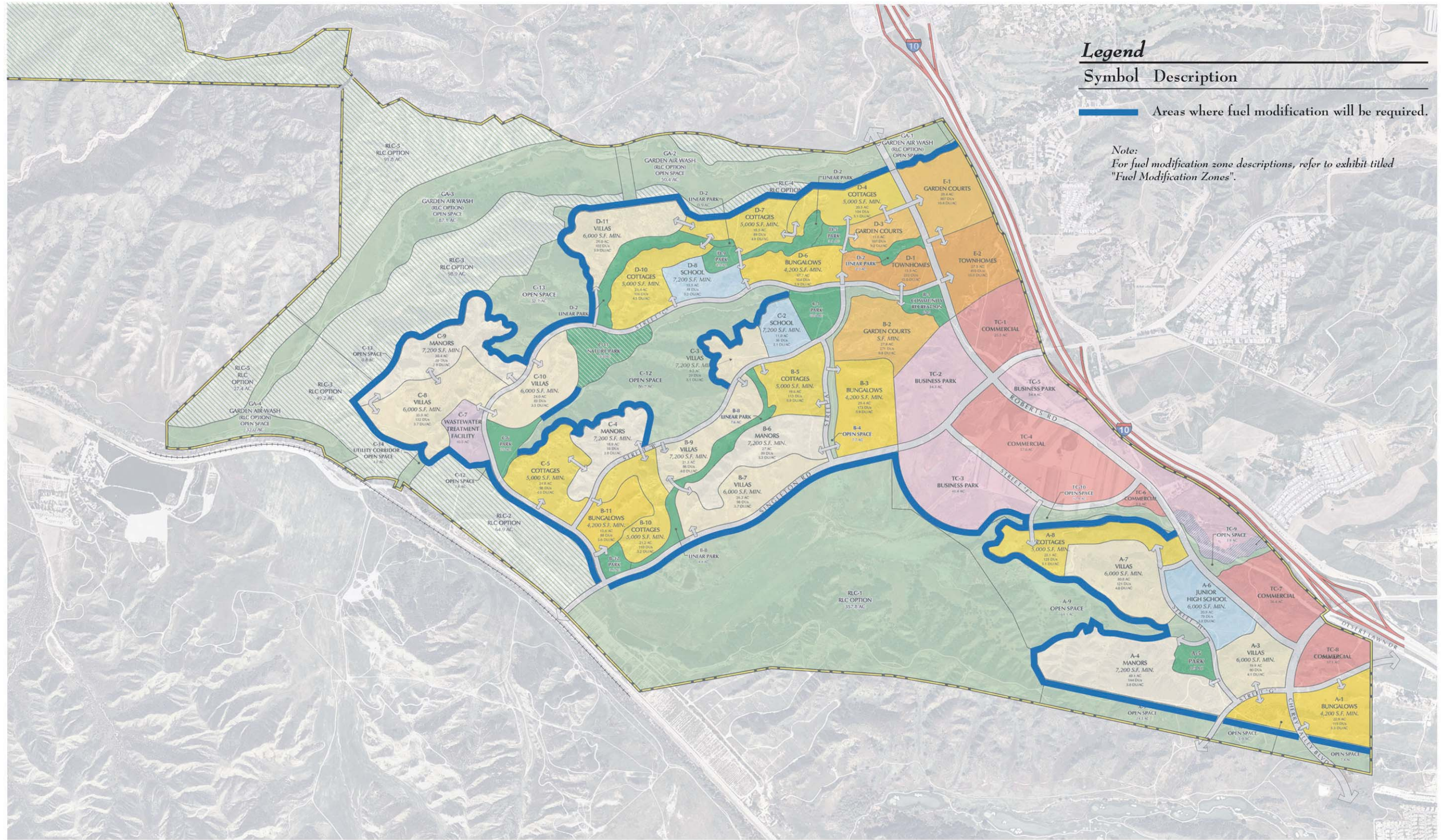

Legend	
Symbol	Description
	Areas where fuel modification will be required.

Note:
For fuel modification zone descriptions, refer to exhibit titled "Fuel Modification Zones".

SUMMERWIND RANCH AT OAK VALLEY

Specific Plan Area No. 1,
Amendment No. 1



FIGURE IV-77

Fuel Modification Areas

General Landscape Requirements

Landscaping should be used to define outdoor spaces (i.e. street edges, outdoor plazas, paseos/trails) and to screen unattractive views and/or features (i.e. storage areas, trash enclosures, loading areas, parking lots, and utility equipment). Hardscape elements should be used in conjunction with landscaping to accent architecture and provide connection between land uses. Ornamental non-native plant materials must be carefully chosen and sited to prevent invasion into adjacent areas. Use of exotic species which are not in the historic vegetation context of the region is discouraged. Maximize the use of native and drought tolerant plant materials, as well as non-native species with low water usage characteristics which are adaptable to hot, dry climates as applicable. Avoid planting of non-native plant species in areas adjacent to the preserved “knoll” areas, to “protect” the natural habitat. Trees planted near public walks or curbs shall be installed in such a manner as to prevent physical damage to sidewalks, curbs, gutters and other public improvements, such as with the use of root barriers. All landscaping and irrigation systems shall be maintained in good condition for as long as the use on the property continues.

All areas required to be landscaped shall be identified on the landscape concept plan submitted with each tentative map. At that time, suggested plant material will also be identified for consideration. Planting shall commence as soon as slopes are completed on any portion of the site and shall provide for rapid short term coverage of the slope as well as long term establishment cover.

The owners of parcels which require landscape development shall assess any existing common landscape areas adjoining their property. Where feasible, landscape development shall reinforce or be compatible with such existing common area setting. The plants selected and planting methods shall be suitable for the soil and climate conditions.

See Figure 4-78 *Street Tree Master Plan* for more information.

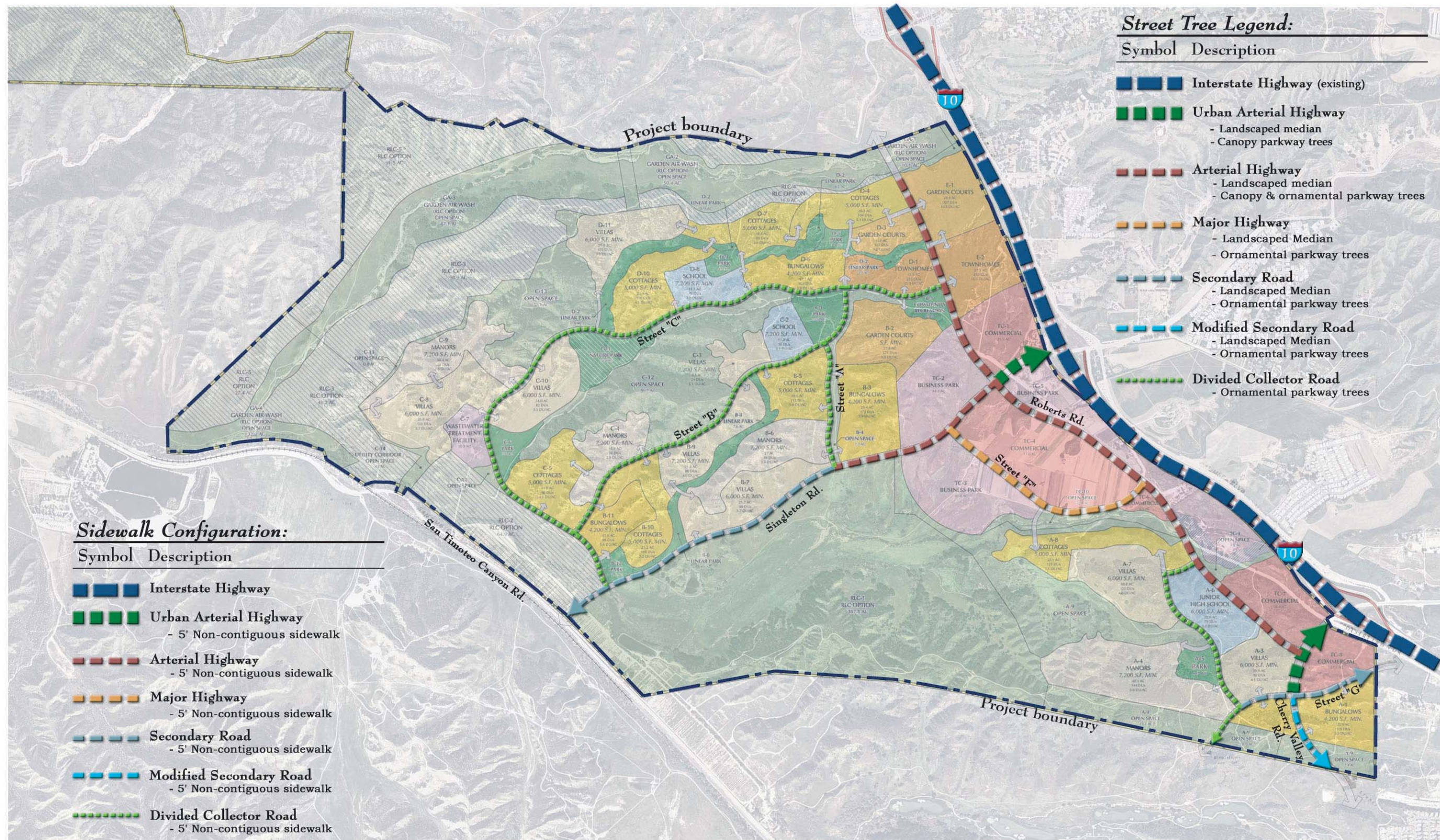

SUMMERWIND RANCH AT OAK VALLEY

Specific Plan Area No. 1,
Amendment No. 1



FIGURE IV-78

Street Tree Master Plan

Specific Plan No. 1, Amendment No. 1 Residential Development Standards

Development Standards	Applicable Planning Areas					
	A4, B6, C2*, C4, C9, D8*	A3, A6*, A7, B7, B9, C3, C8, C10, D11	A8, B5, B10, C5, D4, D7, D10	A1, B3, B11, D6	B2, D3, E1	D1, E2
Minimum Net Lot Area	7,200 sf	6,000 sf	5,000 sf	4,200 sf	3,000 sf	4,200 sf
Uses Permitted	Single Family Detached Homes ⁷	Single Family Detached Homes ⁷	Single Family Detached Homes ⁷	Single Family Detached Homes ⁷	Single Family Detached Homes ⁷	Townhouses and Condominiums ⁷
LOT DIMENSIONS						
Minimum Lot Frontage at Front Property Line	40 feet ¹	40 feet ¹	40 feet ¹	35 feet ¹	35 feet ¹	35 feet ¹
Minimum Average Lot Width	60 feet	45 feet	40 feet	35 feet	35 feet	35 feet
Minimum Lot Depth	100 feet	100 feet	100 feet	85 feet	80 feet	80 feet
Minimum Pad Size	60x60	50x60	40x60	30x60	30x50	30x50
SETBACKS						
Minimum Front Yard	20 feet average ²	20 feet average ²	10 feet	10 feet	10 feet	10 feet
Minimum Corner Side Yard	10 feet	10 feet	10 feet	10 feet	10 feet	10 feet
Minimum Interior Side Yard	5 feet	5 feet	5 feet	Variable ³	Variable ³	Variable ³
Minimum Rear Yard	20 feet	20 feet	20 feet	15 feet	15 feet	15 feet
Garage Setbacks	20 feet ⁴	20 feet ⁴	20 feet	20 feet	20 feet	3 feet
Patio Covers	Post - 5 feet Overhang - 3 feet	Post - 5 feet Overhang - 3 feet	Post - 5 feet Overhang - 3 feet	Post - 5 feet Overhang - 3 feet	Post - 5 feet Overhang - 3 feet	Post - 5 feet Overhang - 3 feet
Maximum Height	40 feet, or two stories, whichever is less					50 feet, or three stories, whichever is less
Minimum Dwelling Size ⁵	2,000 sf	1,800 sf	1,400 sf	1,200 sf	1,200 sf	800 sf
Parking Requirements ⁶	2 spaces / dwelling unit					1.25 spaces / 1 bedroom 2.25 spaces / 2 bedrooms 2.75 spaces / 3 bedrooms

¹ The minimum frontage on knuckles and cul-de-sacs shall be 30 feet

² **Variable Front Yard Setbacks:** In order to allow for a more interesting visual image and more flexible site planning, variable setbacks are required in the front yard. Front yard setbacks shall have an average of 20 feet. Garages with entrances not facing the front yard may be setback a minimum of 10 feet. Other portions of a structure may have a front yard setback of a minimum of 10 feet; however, the average setback shall be maintained

³ **Variable Side Yard Setbacks:** Variable side yard setbacks may be permitted provided the sum of the side yard setbacks is not less than ten feet and the distance between adjacent structures is not less than 10 feet. This permits a zero lot line arrangement with a zero setback on one side and ten feet on the opposite side yard. Eaves and fireplaces shall be allowed within the minimum setbacks.

⁴ Minimum garage setbacks are required to be 30' from the back of curb (20' from the right-of-way) for entrances that face the street unless a roll-up type garage door is used in which case the minimum front garage setback may be reduced to 26' from the back of curb (16' from the right-of-way). A 10' setback is allowed if the garage is a side-entry garage.

⁵ Minimum dwelling areas are computed by calculating the living areas as measured from the outside walls and excludes garages, carports, exterior courtyards patios, or balconies.

⁶ Parking Requirements are based on Riverside County Design Standards.

⁷ Model home complexes and/or sales trailers, and associated parking facilities, landscaping, monumentation, and flags shall be permitted within residential planning areas, subject to administrative site plan approval by City of Calimesa Planning department

* Uses permitted should school district elect not to acquire site

**SPECIFIC PLAN AREA NO. 1, AMENDMENT NO. 1
SUMMERWIND RANCH ZONING ORDINANCE**

The City Council of the City of Calimesa ordains as follows:

This ordinance shall provide the Specific Plan Zone Requirements and Standards for Specific Plan Area No. 1, Amendment No. 1.

1. Planning Area A-1

- (a) Table 5-1, *Specific Plan No. 1, Amendment No. 1 Residential Development Standards*, sets forth uses permitted and minimum site development standards for residential development in Planning Area A-1.
- (b) Uses not permitted in Planning Area A-1 are as follows: agriculture, bed and breakfast inns, guest houses, second dwelling units, and mobile homes. Except as provided above, all other zoning requirements shall be the same as those requirements identified in Chapter 12-305 of the City of Calimesa Development Code.

2. Planning Area A-2

- (a) Table 5-1, *Specific Plan No. 1, Amendment No. 1 Residential Development Standards*, sets forth uses permitted and minimum site development standards for residential development in Planning Area A-2.
- (b) Uses not permitted in Planning Area A-2 are as follows: agriculture, bed and breakfast inns, guest houses, second dwelling units, and mobile homes.
- (c) Except as provided above, all other zoning requirements shall be the same as those requirements identified in Chapter 12-305 of the City of Calimesa Development Code.

3. Planning Area A-3

- (a) Table 5-1, *Specific Plan No. 1, Amendment No. 1 Residential Development Standards*, sets forth uses permitted and minimum site development standards for residential development in Planning Area A-3.
- (b) Uses not permitted in Planning Area A-3 are as follows: agriculture, bed and breakfast inns, guest houses, second dwelling units, and mobile homes.
- (c) Except as provided above, all other zoning requirements shall be the same as those requirements identified in Chapter 12-305 of the City of Calimesa Development Code.

4. Planning Area A-4

- (d) Table 5-1, *Specific Plan No. 1, Amendment No. 1 Residential Development Standards*, sets forth uses permitted and minimum site development standards for residential development in Planning Area A-4.
- (e) Uses not permitted in Planning Area A-4 are as follows: agriculture, bed and breakfast inns, guest houses, second dwelling units, and mobile homes.
- (f) Except as provided above, all other zoning requirements shall be the same as those requirements identified in Chapter 12-305 of the City of Calimesa Development Code.

5. **Planning Area A-5**

- (a) The uses permitted in Planning Area A-5 shall be parks and recreation facilities (public or private).

6. **Planning Area A-6**

- (a) The uses permitted in Planning Area A-6 shall be either educational institutions (including public or private schools) or residential.
- (b) Table 5-1, *Specific Plan No. 1, Amendment No. 1 Residential Development Standards*, sets forth uses permitted and minimum site development standards for residential development in Planning Area A-6.
- (c) Uses not permitted in Planning Area A-6 are as follows: agriculture, bed and breakfast inns, guest houses, second dwelling units, and mobile homes.
- (d) Except as provided above, all other zoning requirements shall be the same as those requirements identified in Chapter 12-305 of the City of Calimesa Development Code.

7. **Planning Area A-7**

- (a) Table 5-1, *Specific Plan No. 1, Amendment No. 1 Residential Development Standards*, sets forth uses permitted and minimum site development standards for residential development in Planning Area A-7.
- (b) Uses not permitted in Planning Area A-7 are as follows: agriculture, bed and breakfast inns, guest houses, second dwelling units, and mobile homes.
- (c) Except as provided above, all other zoning requirements shall be the same as those requirements identified in Chapter 12-305 of the City of Calimesa Development Code.

8. **Planning Area A-8**

- (d) Table 5-1, *Specific Plan No. 1, Amendment No. 1 Residential Development Standards*, sets forth uses permitted and minimum site development standards for residential development in Planning Area A-8.
- (e) Uses not permitted in Planning Area A-8 are as follows: agriculture, bed and breakfast inns, guest houses, second dwelling units, and mobile homes.
- (f) Except as provided above, all other zoning requirements shall be the same as those requirements identified in Chapter 12-305 of the City of Calimesa Development Code.

9. **Planning Area A-9**

- (a) The uses permitted in Planning Area A-9 shall be as follows: communication and telecommunication facilities, flood control facilities, groundwater percolation basins, historical landmarks, riding and hiking trails, and wildlife preserve sanctuaries.

10. **Planning Area B-1**

- (a) The uses permitted in Planning Area B-1 shall be parks and recreation facilities (public or private).

11. **Planning Area B-2**

- (b) Table 5-1, *Specific Plan No. 1, Amendment No. 1 Residential Development Standards*, sets forth uses permitted and minimum site development standards for residential development in Planning Area B-2.
- (c) Uses not permitted in Planning Area B-2 are as follows: agriculture, bed and breakfast inns, guest houses, second dwelling units, and mobile homes.
- (d) Except as provided above, all other zoning requirements shall be the same as those requirements identified in Chapter 12-305 of the City of Calimesa Development Code.

12. **Planning Area B-3**

- (e) Table 5-1, *Specific Plan No. 1, Amendment No. 1 Residential Development Standards*, sets forth uses permitted and minimum site development standards for residential development in Planning Area B-3.
- (f) Uses not permitted in Planning Area B-3 are as follows: agriculture, bed and breakfast inns, guest houses, second dwelling units, and mobile homes.
- (g) Except as provided above, all other zoning requirements shall be the same as those requirements identified in Chapter 12-305 of the City of Calimesa Development Code.

13. **Planning Area B-4**

- (h) The uses permitted in Planning Area B-4 shall be as follows: communication and telecommunication facilities, flood control facilities, groundwater percolation basins, historical landmarks, riding and hiking trails, and wildlife preserve sanctuaries.

14. **Planning Area B-5**

- (a) Table 5-1, *Specific Plan No. 1, Amendment No. 1 Residential Development Standards*, sets forth uses permitted and minimum site development standards for residential development in Planning Area B-5.
- (b) Uses not permitted in Planning Area B-5 are as follows: agriculture, bed and breakfast inns, guest houses, second dwelling units, and mobile homes.
- (c) Except as provided above, all other zoning requirements shall be the same as those requirements identified in Chapter 12-305 of the City of Calimesa Development Code.

15. **Planning Area B-6**

- (a) Table 5-1, *Specific Plan No. 1, Amendment No. 1 Residential Development Standards*, sets forth uses permitted and minimum site development standards for residential development in Planning Area B-6.
- (b) Uses not permitted in Planning Area B-6 are as follows: agriculture, bed and breakfast inns, guest houses, second dwelling units, and mobile homes.
- (c) Except as provided above, all other zoning requirements shall be the same as those requirements identified in Chapter 12-305 of the City of Calimesa Development Code.

16. **Planning Area B-7**

- (a) Table 5-1, *Specific Plan No. 1, Amendment No. 1 Residential Development Standards*, sets forth uses permitted and minimum site development standards for residential development in Planning Area B-7.

- (b) Uses not permitted in Planning Area B-7 are as follows: agriculture, bed and breakfast inns, guest houses, second dwelling units, and mobile homes.
 - (c) Except as provided above, all other zoning requirements shall be the same as those requirements identified in Chapter 12-305 of the City of Calimesa Development Code.
17. **Planning Area B-8**
- (a) The uses permitted in Planning Area B-8 shall be parks and recreation facilities (public or private).
18. **Planning Area B-9**
- (a) Table 5-1, *Specific Plan No. 1, Amendment No. 1 Residential Development Standards*, sets forth uses permitted and minimum site development standards for residential development in Planning Area B-9.
 - (b) Uses not permitted in Planning Area B-9 are as follows: agriculture, bed and breakfast inns, guest houses, second dwelling units, and mobile homes.
 - (c) Except as provided above, all other zoning requirements shall be the same as those requirements identified in Chapter 12-305 of the City of Calimesa Development Code.
19. **Planning Area B-10**
- (a) Table 5-1, *Specific Plan No. 1, Amendment No. 1 Residential Development Standards*, sets forth uses permitted and minimum site development standards for residential development in Planning Area B-10.
 - (b) Uses not permitted in Planning Area B-10 are as follows: agriculture, bed and breakfast inns, guest houses, second dwelling units, and mobile homes.
 - (c) Except as provided above, all other zoning requirements shall be the same as those requirements identified in Chapter 12-305 of the City of Calimesa Development Code.
20. **Planning Area B-11**
- (a) Table 5-1, *Specific Plan No. 1, Amendment No. 1 Residential Development Standards*, sets forth uses permitted and minimum site development standards for residential development in Planning Area B-11.
 - (b) Uses not permitted in Planning Area B-11 are as follows: agriculture, bed and breakfast inns, guest houses, second dwelling units, and mobile homes.
 - (c) Except as provided above, all other zoning requirements shall be the same as those requirements identified in Chapter 12-305 of the City of Calimesa Development Code.
21. **Planning Area B-12**
- (d) The uses permitted in Planning Area B-12 shall be parks and recreation facilities (public or private).

22. **Planning Area C-1**
(a) The uses permitted in Planning Area C-1 shall be the parks and recreation facilities (public or private).
23. **Planning Area C-2**
(a) The uses permitted in Planning Area C-2 shall be either educational institutions (including public or private schools) or residential.
(b) Table 5-1, *Specific Plan No. 1, Amendment No. 1 Residential Development Standards*, sets forth uses permitted and minimum site development standards for residential development in Planning Area C-2.
(c) Uses not permitted in Planning Area C-2 are as follows: agriculture, bed and breakfast inns, guest houses, second dwelling units, and mobile homes.
(d) Except as provided above, all other zoning requirements shall be the same as those requirements identified in Chapter 12-305 of the City of Calimesa Development Code.
24. **Planning Area C-3**
(a) Table 5-1, *Specific Plan No. 1, Amendment No. 1 Residential Development Standards*, sets forth uses permitted and minimum site development standards for residential development in Planning Area C-3.
(b) Uses not permitted in Planning Area C-3 are as follows: agriculture, bed and breakfast inns, guest houses, second dwelling units, and mobile homes.
(c) Except as provided above, all other zoning requirements shall be the same as those requirements identified in Chapter 12-305 of the City of Calimesa Development Code.
25. **Planning Area C-4**
(a) Table 5-1, *Specific Plan No. 1, Amendment No. 1 Residential Development Standards*, sets forth uses permitted and minimum site development standards for residential development in Planning Area C-4.
(b) Uses not permitted in Planning Area C-4 are as follows: agriculture, bed and breakfast inns, guest houses, second dwelling units, and mobile homes.
(c) Except as provided above, all other zoning requirements shall be the same as those requirements identified in Chapter 12-305 of the City of Calimesa Development Code.
26. **Planning Area C-5**
(a) Table 5-1, *Specific Plan No. 1, Amendment No. 1 Residential Development Standards*, sets forth uses permitted and minimum site development standards for residential development in Planning Area C-5.
(b) Uses not permitted in Planning Area C-5 are as follows: agriculture, bed and breakfast inns, guest houses, second dwelling units, and mobile homes.
(c) Except as provided above, all other zoning requirements shall be the same as those requirements identified in Chapter 12-305 of the City of Calimesa Development Code.
27. **Planning Area C-6**
(a) The uses permitted in Planning Area C-6 shall be parks and recreation facilities (public or private).

-
28. **Planning Area C-7**
(a) Uses permitted in Planning Area C-7 shall be as follows: public utilities, communication and telecommunication facilities, flood control facilities, groundwater percolation basins.
29. **Planning Area C-8**
(a) Table 5-1, *Specific Plan No. 1, Amendment No. 1 Residential Development Standards*, sets forth uses permitted and minimum site development standards for residential development in Planning Area C-8.
(b) Uses not permitted in Planning Area C-8 are as follows: agriculture, bed and breakfast inns, guest houses, second dwelling units, and mobile homes.
(c) Except as provided above, all other zoning requirements shall be the same as those requirements identified in Chapter 12-305 of the City of Calimesa Development Code.
30. **Planning Area C-9**
(a) Table 5-1, *Specific Plan No. 1, Amendment No. 1 Residential Development Standards*, sets forth uses permitted and minimum site development standards for residential development in Planning Area C-9.
(b) Uses not permitted in Planning Area C-9 are as follows: agriculture, bed and breakfast inns, guest houses, second dwelling units, and mobile homes.
(c) Except as provided above, all other zoning requirements shall be the same as those requirements identified in Chapter 12-305 of the City of Calimesa Development Code.
31. **Planning Area C-10**
(a) Table 5-1, *Specific Plan No. 1, Amendment No. 1 Residential Development Standards*, sets forth uses permitted and minimum site development standards for residential development in Planning Area C-10.
(b) Uses not permitted in Planning Area C-10 are as follows: agriculture, bed and breakfast inns, guest houses, second dwelling units, and mobile homes.
(c) Except as provided above, all other zoning requirements shall be the same as those requirements identified in Chapter 12-305 of the City of Calimesa Development Code.
32. **Planning Area C-11**
(a) The uses permitted in Planning Area C-11 shall be the parks and recreation facilities (public or private).
33. **Planning Area C-12**
(a) The uses permitted in Planning Area C-12 shall be as follows: communication and telecommunication facilities, flood control facilities, groundwater percolation basins, historical landmarks, riding and hiking trails, and wildlife preserve sanctuaries.
34. **Planning Area C-13**
(a) The uses permitted in Planning Area C-13 shall be as follows: communication and telecommunication facilities, flood control facilities, groundwater percolation basins, historical landmarks, riding and hiking trails, and wildlife preserve sanctuaries.

35. Planning Area D-1

- (a) Table 5-1, *Specific Plan No. 1, Amendment No. 1 Residential Development Standards*, sets forth uses permitted and minimum site development standards for residential development in Planning Area D-1.
- (b) Uses not permitted in Planning Area D-1 include: agriculture, bed and breakfast inns, guest houses, and mobile homes.
- (c) Development shall provide twenty percent (20%) open space for passive and active recreational uses. Open space areas shall not include: right-of-ways or vehicle parking areas.
- (d) Each dwelling unit shall have a private patio or balcony as follows:
 - Ground level units – ten percent (10%) of dwelling unit size.
 - Upper story units – five percent (5%) of dwelling unit size.
- (e) Planning Area D-1 shall provide three recreational amenities within the site, and may include: a swimming pool; spa; clubhouse; tot lot with play equipment; picnic shelter/barbeque area; court game facilities such as tennis, basketball or racquetball; or day care facilities.
- (f) Each unit shall have a minimum of 2 bedrooms and 1 ½ bathrooms.
- (g) Each unit shall be provided with a minimum of one garage space.
- (h) Each unit shall be plumbed and wired for washing machine and dryer.
- (i) Driveway approaches shall be delineated with interlocking pavers and/or rough-textured concrete and landscaped medians.
- (j) A bus turnout and shelter on the on-site arterial frontage shall be dedicated if the project is located on a bus route.
- (k) Lighting designed to reduce hazards and to illuminate potentially unsafe areas such as walkways, passages between buildings, garage areas, parking areas, and areas containing heavy or high foliage shall be installed. Consideration shall be designed to ensure that neighboring properties or public streets are protected from direct or hazardous glare.
- (l) Electronic gates may be provided as follows: A minimum of six (6) foot high, decorative wrought iron fence shall be provided along the front off the property, to the rear of any required setback. Such fence shall incorporate a self-locking remote controlled vehicle and pedestrian entry/exit gate. The vehicle entry shall incorporate an electronically activated tenant marquee to permit notification of tenants in the event of visitors. Such marquee shall be five (5) feet above finished grade.

36. Planning Area D-2

- (a) The uses permitted in Planning Area D-2 shall be parks and recreation facilities (public or private).

37. Planning Area D-3

- (a) Table 5-1, *Specific Plan No. 1, Amendment No. 1 Residential Development Standards*, sets forth uses permitted and minimum site development standards for residential development in Planning Area D-3.
- (b) Uses not permitted in Planning Area D-3 are as follows: agriculture, bed and breakfast inns, guest houses, second dwelling units, and mobile homes.
- (c) Except as provided above, all other zoning requirements shall be the same as those requirements identified in Chapter 12-305 of the City of Calimesa Development Code.

38. **Planning Area D-4**

- (a) Table 5-1, *Specific Plan No. 1, Amendment No. 1 Residential Development Standards*, sets forth uses permitted and minimum site development standards for residential development in Planning Area D-4.
- (b) Uses not permitted in Planning Area D-4 are as follows: agriculture, bed and breakfast inns, guest houses, second dwelling units, and mobile homes.
- (c) Except as provided above, all other zoning requirements shall be the same as those requirements identified in Chapter 12-305 of the City of Calimesa Development Code.

39. **Planning Area D-5**

- (a) The uses permitted in Planning Area D-5 shall be parks and recreation facilities (public or private).

40. **Planning Area D-6**

- (a) Table 5-1, *Specific Plan No. 1, Amendment No. 1 Residential Development Standards*, sets forth uses permitted and minimum site development standards for residential development in Planning Area D-6.
- (b) Uses not permitted in Planning Area D-6 are as follows: agriculture, bed and breakfast inns, guest houses, second dwelling units, and mobile homes.
- (c) Except as provided above, all other zoning requirements shall be the same as those requirements identified in Chapter 12-305 of the City of Calimesa Development Code.

41. **Planning Area D-7**

- (a) Table 5-1, *Specific Plan No. 1, Amendment No. 1 Residential Development Standards*, sets forth uses permitted and minimum site development standards for residential development in Planning Area D-7.
- (b) Uses not permitted in Planning Area D-7 are as follows: agriculture, bed and breakfast inns, guest houses, second dwelling units, and mobile homes.
- (c) Except as provided above, all other zoning requirements shall be the same as those requirements identified in Chapter 12-305 of the City of Calimesa Development Code.

42. **Planning Area D-8**

- (a) The uses permitted in Planning Area D-8 shall be either educational institutions (including public or private schools) or residential.
- (b) Table 5-1, *Specific Plan No. 1, Amendment No. 1 Residential Development Standards*, sets forth uses permitted and minimum site development standards for residential development in Planning Area D-8.
- (c) Uses not permitted in Planning Area D-8 are as follows: agriculture, bed and breakfast inns, guest houses, second dwelling units, and mobile homes.
- (d) Except as provided above, all other zoning requirements shall be the same as those requirements identified in Chapter 12-305 of the City of Calimesa Development Code.

43. **Planning Area D-9**

- (a) The uses permitted in Planning Area D-9 shall be parks and recreation facilities (public or private).

44. Planning Area D-10

- (a) Table 5-1, *Specific Plan No. 1, Amendment No. 1 Residential Development Standards*, sets forth uses permitted and minimum site development standards for residential development in Planning Area D-10.
- (b) Uses not permitted in Planning Area D-10 are as follows: agriculture, bed and breakfast inns, guest houses, second dwelling units, and mobile homes.
- (c) Except as provided above, all other zoning requirements shall be the same as those requirements identified in Chapter 12-305 of the City of Calimesa Development Code.

45. Planning Area D-11

- (a) Table 5-1, *Specific Plan No. 1, Amendment No. 1 Residential Development Standards*, sets forth uses permitted and minimum site development standards for residential development in Planning Area D-11.
- (b) Uses not permitted in Planning Area D-11 are as follows: agriculture, bed and breakfast inns, guest houses, second dwelling units, and mobile homes.
- (c) Except as provided above, all other zoning requirements shall be the same as those requirements identified in Chapter 12-305 of the City of Calimesa Development Code.

46. Planning Area E-1

- (a) Table 5-1, *Specific Plan No. 1, Amendment No. 1 Residential Development Standards*, sets forth uses permitted and minimum site development standards for residential development in Planning Area E-1.
- (b) Uses not permitted in Planning Area E-1 are as follows: agriculture, bed and breakfast inns, guest houses, second dwelling units, and mobile homes.
- (c) Except as provided above, all other zoning requirements shall be the same as those requirements identified in Chapter 12-305 of the City of Calimesa Development Code.

47. Planning Area E-2

- (a) Table 5-1, *Specific Plan No. 1, Amendment No. 1 Residential Development Standards*, sets forth uses permitted and minimum site development standards for residential development in Planning Area E-2.
- (b) Uses not permitted in Planning Area E-2 include: agriculture, bed and breakfast inns, guest houses, and mobile homes.
- (c) Development shall provide twenty percent (20%) open space for passive and active recreational uses. Open space areas shall not include: right-of-ways or vehicle parking areas.
- (d) Each dwelling unit shall have a private patio or balcony as follows:
 - Ground level units – ten percent (10%) of dwelling unit size.
 - Upper story units – five percent (5%) of dwelling unit size.
- (e) Planning Area E-2 shall provide four recreational amenities within the site, and may include: a swimming pool; spa; clubhouse; tot lot with play equipment; picnic shelter/barbeque area; court game facilities such as tennis, basketball or racquetball; or day care facilities.
- (f) Each unit shall have a minimum of 2 bedrooms and 1 ½ bathrooms.
- (g) Each unit shall be provided with a minimum of one garage space.

- (h) Each unit shall be plumbed and wired for washing machine and dryer.
- (i) Driveway approaches shall be delineated with interlocking pavers and/or rough-textured concrete and landscaped medians.
- (j) A bus turnout and shelter on the on-site arterial frontage shall be dedicated if the project is located on a bus route.
- (k) Lighting designed to reduce hazards and to illuminate potentially unsafe areas such as walkways, passages between buildings, garage areas, parking areas, and areas containing heavy or high foliage shall be installed. Consideration shall be designed to ensure that neighboring properties or public streets are protected from direct or hazardous glare.
- (l) Electronic gates may be provided as follows: A minimum of six (6) foot high, decorative wrought iron fence shall be provided along the front off the property, to the rear of any required setback. Such fence shall incorporate a self-locking remote controlled vehicle and pedestrian entry/exit gate. The vehicle entry shall incorporate an electronically activated tenant marquee to permit notification of tenants in the event of visitors. Such marquee shall be five (5) feet above finished grade.

48. Planning Area TC-1

- (a) The uses permitted in Planning Area TC-1 shall be the same as those identified in the Community Commercial Zone (C-C) and Regional Commercial (C-R) Zone in Chapter 12-403 of the City of Calimesa Development Code.
- (b) The development standards for Planning Area TC-1 shall be the same as those identified in Chapter 12-404 except the following:
 - (1) There shall be no minimum lot area requirements.
- (c) Except as provided above, all other zoning requirements shall be the same as those requirements identified in Chapter 12-405 of the City of Calimesa Development Code.

49. Planning Area TC-2

- (a) The uses permitted in Planning Area TC-2 shall be the same as those identified in the Office Professional (O-P) Zone in Chapter 12-403; Light Industrial (L-I) Zone in Chapter 12-502; and Business Park (B-P) Zone of Chapter 12-502 of the City of Calimesa Development Code.
- (b) The development standards for Planning Area TC-2 shall be the same as those identified in Chapter 12-404 except the following:
 - (1) Maximum building height shall be 60 feet, or 5 stories, whichever is less.
 - (2) There shall be no minimum lot area requirements.
- (c) The development standards for Planning Area TC-2 shall be the same as those identified in Chapters 12-404 and 12-504.
- (d) All uses within Planning Area TC-2 shall comply with the performance standards identified in Chapters 12-405 and 12-505 of the City of Calimesa Development Code.

50. Planning Area TC-3

- (a) The uses permitted in Planning Area TC-3 shall be the same as those identified in the Office Professional (O-P) Zone in Chapter 12-403; Light Industrial (L-I) Zone in Chapter 12-502; and Business Park (B-P) Zone of Chapter 12-502 of the City of Calimesa Development Code.

- (b) The development standards for Planning Area TC-3 shall be the same as those identified in Chapter 12-404 except the following:
 - (1) Maximum building height shall be 60 feet, or 5 stories, whichever is less.
 - (2) There shall be no minimum lot area requirements.
- (c) The development standards for Planning Area TC-3 shall be the same as those identified in Chapters 12-404 and 12-504.
- (d) All uses within Planning Area TC-2 shall comply with the performance standards identified in Chapters 12-405 and 12-505 of the City of Calimesa Development Code.

51. Planning Area TC-4

- (a) The uses permitted in Planning Area TC-4 shall be the same as those identified in the Community Commercial Zone (C-C) and Regional Commercial (C-R) Zone in Chapter 12-403 of the City of Calimesa Development Code.
- (b) The development standards for Planning Area TC-4 shall be the same as those identified in Chapter 12-404 except the following:
 - (1) There shall be no minimum lot area requirements.
- (c) Except as provided above, all other zoning requirements shall be the same as those requirements identified in Chapter 12-405 of the City of Calimesa Development Code.

52. Planning Area TC-5

- (a) The uses permitted in Planning Area TC-5 shall be the same as those identified in the Office Professional (O-P) Zone in Chapter 12-403; Light Industrial (L-I) Zone in Chapter 12-502; and Business Park (B-P) Zone of Chapter 12-502 of the City of Calimesa Development Code.
- (b) The development standards for Planning Area TC-5 shall be the same as those identified in Chapter 12-404 except the following:
 - (1) Maximum building height shall be 60 feet, or 5 stories, whichever is less.
 - (2) There shall be no minimum lot area requirements.
- (c) The development standards for Planning Area TC-5 shall be the same as those identified in Chapters 12-404 and 12-504.
- (d) All uses within Planning Area TC-2 shall comply with the performance standards identified in Chapters 12-405 and 12-505 of the City of Calimesa Development Code.

53. Planning Area TC-6

- (a) The uses permitted in Planning Area TC-6 shall be the same as those identified in the Community Commercial Zone (C-C) and Regional Commercial (C-R) Zone in Chapter 12-403 of the City of Calimesa Development Code.
- (b) The development standards for Planning Area TC-6 shall be the same as those identified in Chapter 12-404 except the following:
 - (1) There shall be no minimum lot area requirements.
- (c) Except as provided above, all other zoning requirements shall be the same as those requirements identified in Chapter 12-405 of the City of Calimesa Development Code.

57. Planning Area TC-7

- (a) The uses permitted in Planning Area TC-7 shall be the same as those identified in the Community Commercial Zone (C-C) and Regional Commercial (C-R) Zone in Chapter 12-403 of the City of Calimesa Development Code.
- (b) The development standards for Planning Area TC-7 shall be the same as those identified in Chapter 12-404 except the following:
 - (1) There shall be no minimum lot area requirements.
- (c) Except as provided above, all other zoning requirements shall be the same as those requirements identified in Chapter 12-405 of the City of Calimesa Development Code.

58. Planning Area TC-8

- (a) The uses permitted in Planning Area TC-8 shall be the same as those identified in the Community Commercial Zone (C-C) and Regional Commercial (C-R) Zone in Chapter 12-403 of the City of Calimesa Development Code.
- (b) The development standards for Planning Area TC-8 shall be the same as those identified in Chapter 12-404 except the following:
 - (1) There shall be no minimum lot area requirements.
- (c) Except as provided above, all other zoning requirements shall be the same as those requirements identified in Chapter 12-405 of the City of Calimesa Development Code.

59. Planning Area TC-9

- (a) The uses permitted in Planning Area TC-9 shall be as follows: communication and telecommunication facilities, flood control facilities, groundwater percolation basins, historical landmarks, riding and hiking trails, and wildlife preserve sanctuaries.

60. Planning Area TC-10

- (a) The uses permitted in Planning Area TC-10 shall be as follows: communication and telecommunication facilities, flood control facilities, groundwater percolation basins, historical landmarks, riding and hiking trails, and wildlife preserve sanctuaries.

61. Planning Area RLC-1

- (a) The uses permitted in Planning Area RLC-1 shall be as follows: riding and hiking trails and wildlife preserve sanctuaries.

62. **Planning Area RLC-2**

(a) The uses permitted in Planning Area RLC-2 shall be as follows: riding and hiking trails and wildlife preserve sanctuaries.

63. **Planning Area RLC-3**

(a) The uses permitted in Planning Area RLC-3 shall be as follows: riding and hiking trails and wildlife preserve sanctuaries.

64. **Planning Area RLC-4**

(a) The uses permitted in Planning Area RLC-2 shall be as follows: riding and hiking trails and wildlife preserve sanctuaries.

65. **Planning Area RLC-5**

(a) The uses permitted in Planning Area RLC-5 shall be as follows: riding and hiking trails and wildlife preserve sanctuaries.

66. **Planning Area GA-1**

(a) The uses permitted in Planning Area GA-1 shall be as follows: riding and hiking trails and wildlife preserve sanctuaries.

67. **Planning Area GA-2**

(a) The uses permitted in Planning Area GA-2 shall be as follows: riding and hiking trails and wildlife preserve sanctuaries.

68. **Planning Area GA-3**

(a) The uses permitted in Planning Area GA-3 shall be as follows: riding and hiking trails and wildlife preserve sanctuaries.

69. **Planning Area GA-4**

(a) The uses permitted in Planning Area GA-4 shall be as follows: riding and hiking trails and wildlife preserve sanctuaries.

VI. HILLSIDE DEVELOPMENT REGULATIONS

a. Purpose and Intent

These provisions are designed to address impacts of development in hillside areas and ensure that Summerwind Ranch at Oak Valley is developed in an environmentally sensitive manner which protects the public health, safety, and welfare. In addition, these guidelines are intended to minimize the alteration, reduction and removal of the natural view shed and create a more desirable living environment by creating design standards and criteria for hillside development. This section provides for the implementation of varied site design, land planning and development through the application of and working in conjunction with the Specific Plan Amendment. This further encourages the preservation of sensitive environmental areas and natural features in open space by application of standard development regulations in this Specific Plan Amendment.

b. Definitions

The following definitions apply for the purposes of administering, interpreting and enforcing this Specific Plan Amendment.

As-graded	The surface configuration upon completion of grading.
Balance	The grading of a site which requires neither the export or import of earth material.
Bench	Relatively level step excavated into earth material on which fill is to be placed or intermediate drainage area.
Bench Drain	A generally horizontal drainage feature on a manufactured slope usually in the form of a gunited concrete v-ditch with a minimum of five (5%) percent slope.
Berm	A low mound of earth graded in a linear or undulating form; often used as a noise or visual barrier.
Building Height	The vertical distance measured from the ground level grade to the top of the roof.
Building Line	An imaginary line on a building site specifying the closest point from an ultimate right-of-way line or a property line where a main building may be located.
Canyon	A deep, narrow valley having high, steep slopes.
Clustering	The process of reducing required lot sizes while allowing permitted densities on a smaller site area in order to preserve open space, sensitive or hazardous areas.
Contour	A line drawn on a plan which connects all points of equal elevation.
Contour Grading	Grading techniques applied to provide earth forms that follow natural contours by minimizing long straight manufactured cut or fill slopes. Techniques may include slope rounding and variable slope ratios.
Crib Wall	An earth-retaining structure with nearly vertical face constructed of modular preformed materials.
Creek	A natural stream of running water larger than a brook and smaller than a river.
Cut	The mechanical removal of earth material.
Cut and Fill	The excavating of material in one place and depositing of it as fill in another place.
Daylight Line	The line between grading and natural terrain drawn by connecting the points where proposed contours meet existing contours.
Earth Material	Any rock, natural soil or fill and/or any combination thereof.
Elevation	Height or distance above sea level.

Erosion	The process by which the soil and rock components of the earth's crust are worn away and removed from one place to another by natural forces such as weathering, solution and transportation.
Excavation	The mechanical removal of earth material.
Existing Grade	The grade prior to grading.
Export	Excess cut that is removed from a grading project and deposited offsite.
Exterior Slopes Utilizing Natural Slope Restoration	Slopes that utilize a revegetation method that will not require either temporary, supplemental or permanent irrigation systems. The restoration process will include the grinding of native plant material that is removed from the site during initial grading operations and replanting of this ground up plant material by compacting it in a layered manner atop manufactured slopes, thus utilizing non-invasive native plant material that is indigenous to the area, sensitive to the surrounding environment and that utilizes natural ecological succession as a means to provide mature climax plant development that is integrated with the environmental surroundings. This method will require an increased period for developer maintenance to insure that restoration, revegetation and erosion control goals are met.
Fill	A deposit of earth material placed by artificial means.
Finish Grade	The final grade of the site which conforms to the approved plan.
Flood Plain	The land area adjacent to a watercourse which is subject to the overflow of flood waters.
Foothill	A hill at the base of a mountain.
Grade	The vertical location of the ground surface.
Grade Separation	The separation at different levels of two intersecting roads, by bridge, tunnel or underpass, so as to permit the roads to cross without obstructing free traffic movement on either
Grading	Any excavating or filling or combination thereof.
Hill	A small area of land that is higher than the land around it.
Hillside	A parcel of land or a definable portion thereof with an average rise or fall of more than (1) foot vertically for each sixteen (6) feet horizontally (16% slope).
Hydrology	The properties of the water, including circulation and distribution, on and below the ground.
Import	Fill material obtained offsite to balance a grading project.
Knoll	A small, round hill or mound.
Land	The portion of the earth's surface above the level of the sea or ocean.
Minimal Grading	A grading concept designed to minimize excavation and filling. Minimal grading is often associated with roads conforming closely to natural contours with the structures being built on natural terrain.
Mountain	A lofty elevation on the earth's surface.
Native Vegetation	The natural vegetation commonly found in an area.
Natural Areas	Undeveloped sites which have not been graded.
Natural Open Space	Natural open space will refer to the landform as created by nature, or as subsequently modified by either agricultural activities or to meet fuel modification fire standards. Within natural open spaces, vegetation introduced for agricultural purposes may be removed and the area revegetated. Existing trees, riparian vegetation and native plant communities within natural open spaces will be

Natural Slope	<p>preserved and protected. Manmade water bodies and trails through natural open spaces may be considered as natural open space.</p> <p>A slope which is not man-made. A natural slope may retain the natural vegetation during adjacent grading operations or it may be partially or completely removed and replanted.</p>
Natural Slope Restoration	<p>A revegetation process and technique utilized on manufactured slopes adjacent to open space that will not require either temporary, supplemental or permanent irrigation systems that consist of grinding of native plant material that is removed from the site during initial grading operations and replanting of this ground up plant material by compacting it in a layered manner atop manufactured slopes, thus utilizing non-invasive native plant material that is indigenous to the area, sensitive to the surrounding environment and that utilizes natural ecological succession as a means to provide mature climax plant development that is integrated with the environmental surroundings. This method will require an increased period for developer maintenance to insure that restoration, revegetation and erosion control goals are met.</p>
Open Space	<p>Land not covered by buildings, roads or vehicular access ways and including such areas as private yards, landscaped areas, slopes, natural areas, common areas, greenbelts, parks and areas of recreation as described in Section III-2 of this Specific Plan Amendment.</p>
Pad Peak Permanently Irrigated Interior Slopes	<p>A generally flat or stepped area created by grading to accommodate development.</p> <p>The highest part of a mount; usually steep sided at the summit.</p>
Ridge Sensitive Environmental Areas	<p>Slopes three feet or greater that are not adjacent to open space that face other built architectural elements and/or streets. These manufactured slopes will utilize a permanent irrigation system to assist in plant development for slope stabilization. Plant material utilized in these areas may be any one or combination of irrigated hydroseeds, groundcovers, shrubs, vines and trees of ornamental or native character that compliments the overall community theme. Plants used on these slopes will be drought tolerant and fire retardant.</p> <p>A long, narrow or sharply defined conspicuous elevation of land.</p> <p>Areas identified in this Specific Plan Amendment that are considered of high environmental value and should not be developed as illustrated in Figure 6-1, <i>Sensitive Environmental Areas Map</i>.)</p>
Setback Area	<p>The area between the building line and the property line, or when abutting a street, the ultimate right-of-way line.</p>
Setback Distance	<p>The distance between the building line and the property line, or when abutting a street, the ultimate right-of-way line.</p>
Significant Ridge	<p>A ridge or hill that is visible from arterial streets or major public space, which forms a part of the skyline or is seen as a distant edge against a backdrop of land as designated by Figure 6-1, <i>Sensitive Environmental Areas Map</i>.</p>
Single-loaded Street Site	<p>A street with lots fronting on one side only.</p> <p>Any lot or parcel of land or contiguous combination thereof, under the same ownership, where grading is performed or permitted.</p>
Slope	<p>An inclined ground surface, the inclination of which is expressed as a ratio of horizontal distance to vertical distance.</p>

Slope Bank	A man-made slope steeper than 5:1 (20%).
Slope- Man-made Slope	A manufactured slope consisting wholly or partly of either cut or fill.
Transition	The area where a slope bank meets the natural terrain or a level graded area either vertically or horizontally.
Summit	Highest part of a hill or mountain.
Topography	General term to include characteristics of the ground surface such as plains, hills, mountains, degree of relief, steepness of slope and other physiographic features.
Toe of Slope	The lowest elevation of a slope which transitions to a flatter area or pad.
Top of Slope	The highest elevation of a slope.
Uniform Slope	A slope of a uniform slope ratio.
Wildlife Corridor	A strip or block of habitat connecting otherwise isolated units of suitable habitats that allows the dispersal of organisms and the consequent mixing of genes. Wildlife corridors are created as a means of conservation or general improvement of the environment.
Valley	The land between hills or mountains, often containing a stream.
Variable Slope	A man-made slope (usually a slope bank) which has a variety of slope ratios rather than a single ratio.
Vegetation	Growing plants.
Viewshed	Areas or development which can be viewed from arterial roads, freeways, major collector roads and public gathering places such as major shopping centers.

c. Policies

Development within this Specific Plan Amendment is intended to advance the following:

- (1) To conserve the identified significant ridges, canyons, valleys, and wildlife corridors which give Summerwind Ranch at Oak Valley its distinctive character. See Figure 6-1, *Sensitive Environmental Areas Map*, for locations of these elements.
- (2) To create open spaces which preserve wildlife corridors, significant ridgelines, canyons, valleys, and riparian areas.
- (3) To site dwellings and other structures in a manner which is compatible with natural drainage patterns and physical landforms through sensitive grading design and architecture.
- (4) To encourage grading designed to complement the natural terrain.
- (5) To provide safe vehicular circulation patterns for residents, safety and service providers.
- (6) To utilize landscape design to enhance slope stability, restore slopes adjacent to open space to their natural character, and to soften grading through the selection of appropriately sized (when mature) and appropriately placed plant materials.

d. Hillside Classifications

- (1) Hillside classifications have been established to identify categories relative to hillside development. These categories have been classified in terms of average slope types with respect to different topography categories, as follows:

Slope Type	
0-15%	Flat, Gentle, Rolling Land
16-20%	Hillside

- 21-25% Steep Hillside
- 26-30% Very Steep Hillside
- 31-45% Mountainside Terrain
- 45%+ Steep Mountainside Terrain

- (2) Slopes of zero to fifteen percent (0-15%) consist of flat, gentle, rolling land. Within this category, flat land can be defined as slopes of zero to five percent (0-5%), gentle land as slopes of six to ten percent (6-10%) and rolling land as slopes of eleven to fifteen percent (11-15%). Slopes of zero to five percent (0-5%) normally pose no major restriction to development, except in terms of landscaping and maintenance for the small amounts of slope created. Slopes of six to ten percent (6-10%) are flexible as to local road orientation and site layout. There are generally no significant constraints associated with this category, but it is more restrictive than flat land. Slopes of eleven to fifteen percent (11-15%) are affected in terms of road alignment in that roads will normally be required to parallel contours. More significant grading is required to create flat pad areas, and the orientation of site planning, such as orienting pads, begins to be restricted in terms of access and the ability to grade flat sites.

In hillside areas of sixteen to twenty percent (16-20%), twenty one to twenty five percent (21-25%) and twenty six to thirty percent (26-30%) slope, the required quantities of earthwork necessary for grading to create flat pads increases dramatically, as does the significance of view opportunities and visual prominence. Development in areas with slopes of sixteen percent (16%) and above will require contour grading where feasible.

In mountainside areas with slopes of thirty one to forty five percent (31-45%), both access and the ability to create pads using 2:1 slopes are restricted. In areas with average slopes of forty five percent (45%) or greater, development is discouraged. Without the use of retaining walls, access is difficult and the grading of pads on side slopes of forty five percent (45%) or greater is difficult without cutting hilltop areas and filling valleys.

e. Ridgeline Preservation

Development applications that are consistent with this adopted Specific Plan Amendment need not be further analyzed for compliance with the following studies. Any impending project that proposes an amendment to this document shall prepare and comply with the following:

- (1) A view analysis for Summerwind Ranch at Oak Valley depicting “before-and-after” construction conditions shall be prepared, with a minimum of three (3) selected vantage points, showing a precise depiction of the potential visual impacts of the proposed project. The analysis may incorporate the use of a three-dimensional computer models or photographs incorporating and utilizing a height reference of the proposed development in order to display the impact of development on significant ridgeline views.
- (2) Development requirements for ridgeline preservation are:
- a. No structure will be permitted within one hundred fifty feet (150’) horizontal distance from the centerline of significant ridgelines as identified in Figure 6-1, *Sensitive Environmental Areas Map*, and no finished pad will be allowed within fifty feet (50’) of the top elevation of the adjacent ridge.

- b. Contour elevation on each of the adjacent ridgelines designated for preservation, above which no adjacent development will occur, has been identified.
- c. Provided development is in conformance with these guidelines, further view analysis and review of the above shall not be required unless warranted by amendment to this Specific Plan Amendment.

f. **Design Criteria**

- (1) The slope-open space relationship below is to be used to determine open space requirements for this development based on the slope of the land. One column defines the percentages of slope within a project that are to be categorized. The other column indicates the proportion of each slope category that should be left as natural open space. In any case where the minimum percent of open space is not achievable in one particular slope category, the equivalent amount of open space shall be transferred and preserved elsewhere within the project.

Actual Slope Category (%)	Minimum % of Natural Open Space
0-15	0
16-20	20
21-25	35
26-30	50
31-45	75
45+	90

- (2) The relationship in the table above is designed so that, as the steepness of the land increases, the project-wide open space requirement increases. This criterion does not necessarily, however, prohibit development on steep slopes, nor does it necessarily reduce the permitted density.
- (3) Other public health, safety or welfare considerations could also increase the open space requirements for a project.
- (4) Figure 6-2, *Slope Map*, includes information as required this section, together with the following information:
 - a. A topographic map of the proposed project area at a scale of not less than one (1) inch to two hundred feet (200'). The contour interval is not more than two feet (2'), except that the contour interval of five feet (5') where the general slope is more than ten percent (10%).
 - b. The topographic map has been prepared and certified by a registered civil engineer.
 - c. Land within each slope category, e.g. zero to fifteen percent (0-15%), have been delineated. The area in acres shall be tabulated for each category. The values listed above are applied accumulatively for the entire Specific Plan Amendment area.
 - d. The amount of land to be left in natural open space for this project has been computed by multiplying the number of acres of the project area within each average slope category by the required percentage of natural open space for that category. The totals for each category have been summed to yield the total natural open space requirement for the project.

g. **Grading**

- (1) Grading will be phased so that revegetation or construction will control erosion. Revegetated slopes will consist of two primary types: permanently irrigated interior slopes and exterior slopes utilizing natural slope restoration.

Permanently Irrigated Interior Slopes: Permanently irrigated interior slopes consist of manufactured slopes three feet or greater that are not adjacent to open space that face other built architectural elements and/or streets. These manufactured slopes will utilize a permanent irrigation system to assist in plant development for slope stabilization. Plant material utilized in these areas may be any one or combination of irrigated hydroseeds, groundcovers, shrubs, vines and trees of ornamental or native character that compliments the overall community theme. Plants used on these slopes will be drought tolerant and fire retardant.

Exterior Slopes Utilizing Natural Slope Restoration: Exterior slopes utilizing natural slope restoration techniques will be used on manufactured slopes 3' feet or greater that are directly adjacent to natural open space areas. These manufactured slopes will utilize a revegetation method that will not require either temporary, supplemental or permanent irrigation systems. The restoration process will include the grinding of native plant material that is removed from the site during initial grading operations and replanting of this ground up plant material by compacting it in a layered manner atop manufactured slopes, thus utilizing non-invasive native plant material that are indigenous to the area, sensitive to the surrounding environment and that utilizes natural ecological succession as a means to provide mature climax plant development that is integrated with the environmental surroundings. This method will require an increased period for developer maintenance to insure that restoration, revegetation and erosion control goals are met. Where possible, only those areas which will be built on, resurfaced or landscaped will be disturbed.

- (2) Grading operations will be prohibited unless an erosion control plan has been submitted and approved by the City Engineer to avoid adverse effects caused by rain, wind or other weather conditions.
- (3) Cut and fill materials that are added or taken away from the site will be transported according to a haul route approved by the City Engineer.
- (4) Erosion and sediment control plans will be prepared and accomplished according to best management practices, as defined in the Riverside County Drainage Area Master Plan as required by the National Pollutant Discharge Elimination System (NPDES). Proof the required permits and notifications have been completed will be presented to the City at time of grading permit application and issuance.
- (5) Contour Grading, required on areas of 16% slope and greater, will be carried out in accordance with the standards illustrated in Figure 6-3, *Contour Grading Concept*. This requirement shall be waived on small or insignificant portions of the project site pending review by the City Engineer.
- (6) Slope Maintenance:
- a. No final subdivision map shall be approved without preparation and recordation of a declaration of covenants, conditions and restrictions or participation in a Lighting, Landscape and Maintenance sub area or other City approved arrangement providing for the development and maintenance of slopes, as required by the Hillside Development Regulations.
 - b. No final subdivision map will be approved without the subdivider supplying a program and/or staff for preventative maintenance of major manufactured slope areas. Such program will be approved prior to approval of a final map and will

include homeowner slope maintenance requirements and guidelines to be incorporated into the declaration of covenants, conditions and restrictions or participation in Lighting, Landscape and Maintenance sub area or other City approved arrangement.

- (7) The maximum grade of cut-and-fill slopes will not exceed 2:1 except that the cut-and-fill slope may be as steep as 1.5:1 with written approval from a soils engineer and review and approval of the City Engineer.
- (8) The maximum slope height for visible northerly and northeasterly cut and fill slopes shall be sixty feet (60'). All slopes will have a two foot flat bench adjacent to property lines to accommodate wall and fence footings and maintenance access and shall then after be rounded at the top of the slope to a maximum of fifteen feet (15') radius. Cut and fill slopes may exceed this requirement, upon approval of the City Engineer when special circumstances exist and impacts can be mitigated.
- (9) Prohibited Development/Grading Locations:
 - a. Within seventy-five feet (75') of any natural body of water identified for preservation.
 - b. In unmitigated geologic hazard areas, or any other area identified to be unsafe in the geologic report.
 - c. In the environmentally sensitive areas shown on Figure 6-1, *Environmentally Sensitive Areas Map*.
 - d. In areas subject to flooding or other hazards, except as required for utilities and road crossings.
- (10) Setbacks of the Specific Plan Amendment:
 Generally, minimizing required setbacks, especially front and rear setbacks, may reduce grading by reducing the overall width of road and structure arrangements. Reduced setbacks also help to give the streetscape a more human scale. Varying the use of reduced and standard setbacks will allow the flexibility to adapt to hillside features and avoid monotonous application of a consistent standard.

h. Retaining Walls/Fences

(1) Retaining Walls

- a. Retaining walls on the upslope (from a building or structure) on a lot will be a maximum of six feet (6') in height. Retaining walls in the side yard of a lot will be a maximum of four feet (4'). Retaining walls on the downslope (from a building or structure) facing the public right-of-way will not exceed three feet (3') in height. Terraced walls may be used with planters in between the walls to soften the effects within a minimum horizontal spacing of three feet (3'). Terraced walls will not exceed three feet (3') in height. Adjacent to roadways, retaining walls will be a maximum of four feet (4') high, or a total of six feet (6') if two (2) three foot (3') walls are used in combination with a minimum horizontal spacing of three feet (3'). Height and spacing variations may be granted upon review by the City Engineer. Retaining walls which are an integral part of a building or structure will not exceed eight feet (8') in height. Visual impacts of such a building or structure will be mitigated through contour grading and landscaping techniques where feasible. Fences placed on top of retaining walls shall not be calculated as a part of the height requirements.
- b. Retaining walls will be designed with smooth, continuous lines that conform to the topography.

(2) Fences and Walls

- a. Fencing of individual lots will be discouraged on natural slope areas exceeding sixteen percent (16%) slope. View fences may be permitted with the approval of the Planning Director.
- b. Fencing of individual lots will be allowed on manufactured or graded slopes where the homeowner or homeowners association has maintenance responsibilities.
- c. Privacy walls and fences, not exceeding six feet (6') in height, are permitted adjacent to structures in order to provide a private outdoor area. All fences which are adjacent to or visible from public roads or major public spaces will be constructed of decorative masonry or other approved materials which blend with the surrounding landscape.
- d. Free standing walls integral to a structure will be of the same material and design as the structure. The height of such walls will not exceed six feet (6').
 - i. Free standing wall setbacks along front yards will be varied to avoid creating an unbroken, uniform streetscape. The height of such walls will not exceed four (4) feet.
 - ii. Continuous rear yard fences and walls across tops of slopes may be view fences or walls and will be coordinated in design and use of materials.
 - iii. Block wall setbacks on slopes will be 2 foot minimum.

i. Architectural Standards

See Section 4.0, *Design Guidelines*, of this Specific Plan Amendment.

j. Drainage

- (1) The following drainage components will be utilized to complement standard engineering practice and County Flood Control standards:
 - a. Debris basins, rip-rap and energy dissipating devices will be provided where necessary to reduce erosion when grading is undertaken. Except for necessary flood control facilities, significant natural drainage courses will be protected from grading activity and man-made facilities. In instances where crossing is required, arched culverts with soft bottoms will be preferred to box culverts and pipe. Where brow ditches are required, they will be naturalized with plant materials or native rocks.
 - b. Building and grading permits will not be issued for construction on any site without an approved location for disposal of runoff waters, including but not limited to such facilities as a drainage channel, detention basins, public street or alley or private drainage easement.
 - c. All cuts will be drained.
 - d. The use of drainage across lots will be permitted, subject to City Engineer review, and may be approved after demonstration that this method will not adversely affect the proposed lots or adjacent properties, and that it is required in order to minimize the amount of grading which would result with conventional drainage practices. Where drainage across lots is utilized, the following will apply:
 - i. Project interiors – One lot may drain across another lot if an easement is provided and improved, using an open V-swale gutter which has a naturalized appearance, or within a closed drainage pipe which will be a minimum twelve (12) inches in diameter. In both cases, an integral wall will be constructed. This drainage will be conveyed to either a public street or to a drainage easement. If drainage is conveyed to a private easement, it will be maintained by a homeowners association, otherwise the drainage will be conveyed to a public

easement. The easement width will be determined on an individual basis and will be dependent on appropriate hydrologic studies and access requirements.

- ii. Project boundaries – Onsite drainage will be conveyed in an improved open V-swale gutter which has a naturalized appearance, or within an underground pipe in either a private drainage easement, which is to be maintained by a homeowners association or other approved mechanism, or it will be conveyed in a public easement. The easement width will be determined on an individual basis and will be dependent on appropriate hydrologic studies and access requirements.
- e. Where possible, drainage channels should be placed in inconspicuous locations. More importantly, they should receive a naturalizing treatment, including native rock, colored concrete and landscaping, so that the structure appears as an integral part of the environment.
- f. Natural drainage courses should be preserved and enhanced to the extent possible. Natural drainage and terrain features should be incorporated as an integral part of the project design. In areas where natural slope restoration occurs on manufactured slopes, and/or is implemented as described above, V-swale gutters will only be required around the top perimeter of the slope.

k. Application Submittal

(1) Tentative Tract Map: The applicant will submit an adequate number of copies, as determined by the Planning Director, of a Tentative Tract Map showing proposed lots at a scale of not less than 1"=100', and a contour interval of two (2) feet. The map will include the following:

- Lot size (sq. ft.)
- Lot dimensions
- Pad elevation of each lot
- Daylight lines for all pad areas
- Daylight lines for all slope areas with direction of slope indicated
- Lot numbers
- Street cross-sections
- Street grades
- Adjacent improvements
- Vicinity map

(2) Data will be provided describing existing soils, geology and drainage.

(3) Conceptual landscape plans illustrating landscaping techniques and materials for all cut and fill slopes, will be prepared for the public hearings.

Development applications that are consistent with this adopted Specific Plan Amendment need not be further analyzed for compliance. Any impending project that proposes an amendment to this document shall prepare and comply with the following:

- (1) Visualizations and/or models, demonstrating before and after conditions

l. Action of Planning Director Implementing Development

Planning Director: The Planning Director will approve, conditionally approve or deny any development application which falls within the scope of this Specific Plan Amendment.

m. Action of Commission Implementing Development

Planning Commission: The Planning Commission will approve, conditionally approve or deny any development application which falls within the scope of this Specific Plan Amendment, following the close of the noticed public hearing conducted on the application. In addition to any other findings necessary to the development project approval the Planning Commission will make the following findings:

- (1) The proposed project is consistent with the purpose, intent, policies and development standards of Specific Plan Area No. 1, Amendment No. 1.
- (2) The design of the project protects the public health, safety and welfare.
- (3) The proposed conditions are necessary to carry out the intent and purpose of Specific Plan Area No. 1, Amendment No. 1.

n. Issuance of Grading Permit

No grading permit for any tract map, parcel map, grading plan or single family building permit will be issued until the City Engineer determines compliance with Specific Plan Area No. 1, Amendment No. 1. No grading permit will be issued for any tentative tract or parcel map in the Specific Plan Area No. 1, Amendment No. 1. area until the conditions of approval for grading have been met and property securities or bonds posted with the City.

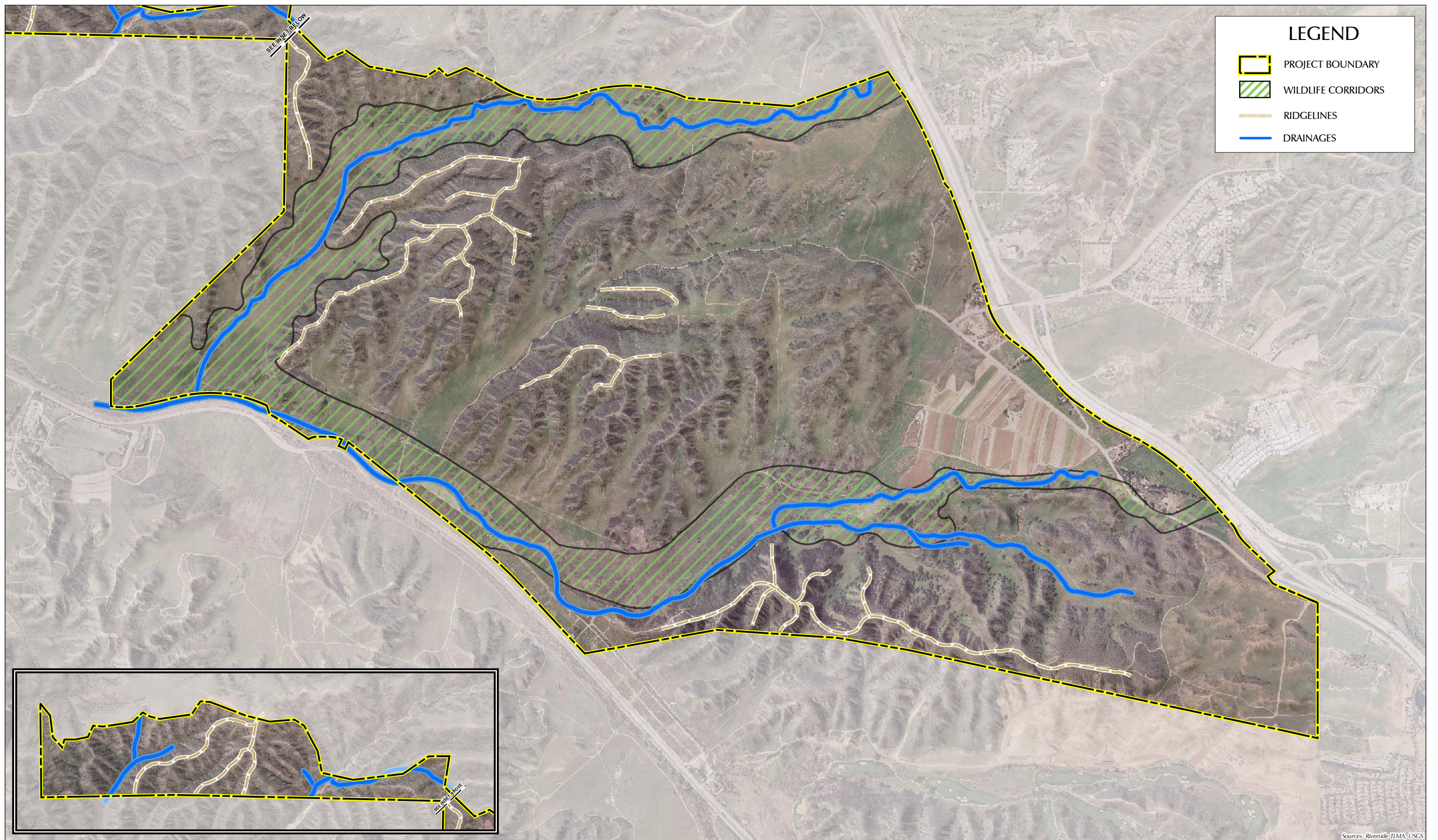

LEGEND

- PROJECT BOUNDARY
- WILDLIFE CORRIDORS
- RIDGELINES
- DRAINAGES

SUMMERWIND RANCH AT OAK VALLEY

Specific Plan Area No. 1,
Amendment No. 1



Sources: Riverside TILMA, USGS

FIGURE VI-1

SENSITIVE ENVIRONMENTAL AREAS MAP



Source: Riverside TLMA, USGS, TKC

SUMMERWIND RANCH AT OAK VALLEY

Specific Plan Area No. 1,
Amendment No. 1

T&B PLANNING CONSULTANTS
17742 East 17th Street, Suite 100, Tustin, CA 92780
p: 714.309.6360 f: 714.309.6363
www.tbplanning.com



FIGURE VI-2

SLOPE ANALYSIS MAP

PAGE VI-13

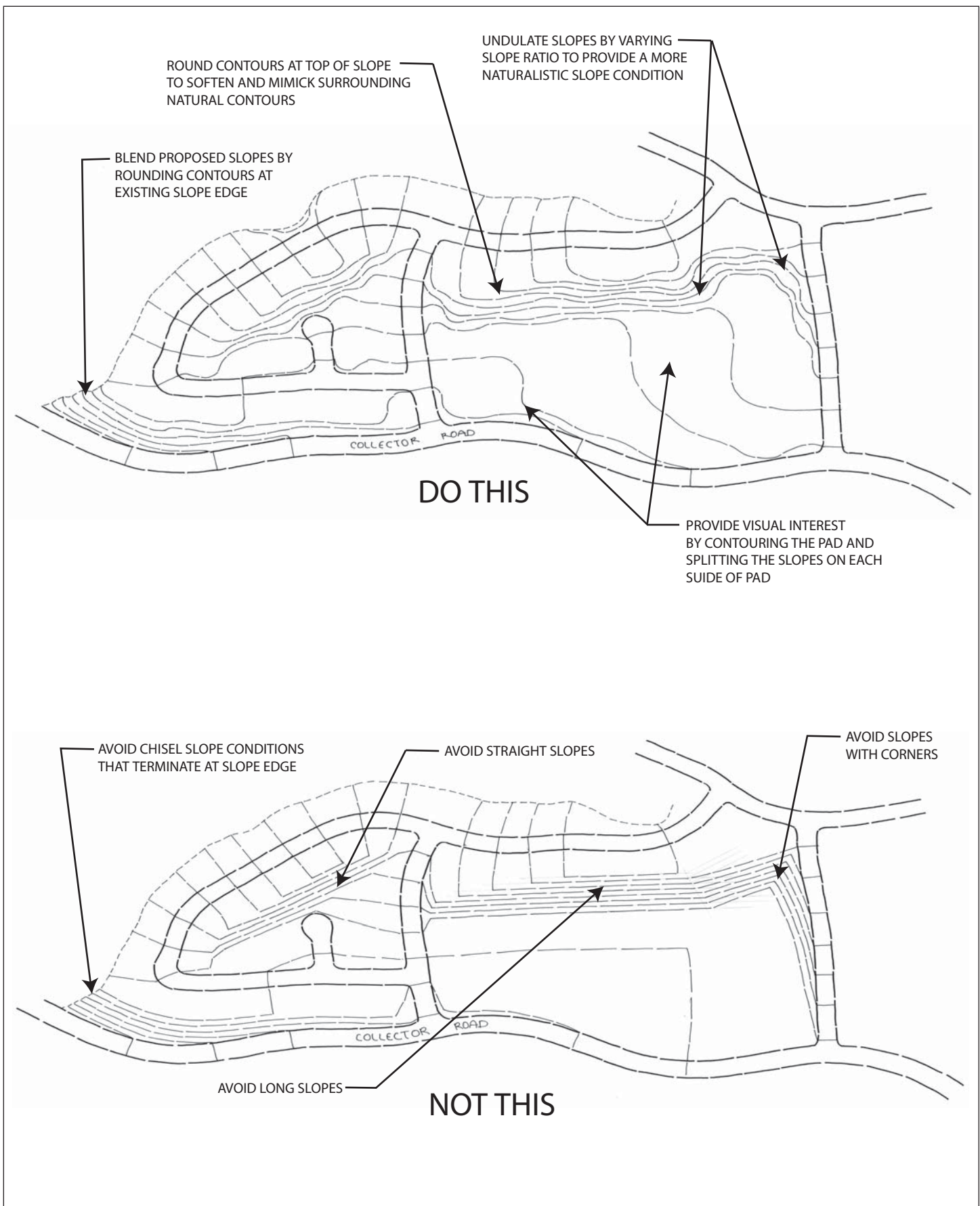

SUMMERWIND RANCH AT OAK VALLEY

Specific Plan Area No. 1,
Amendment No. 1



FIGURE VI-3
CONTOUR GRADING CONCEPT

VII. OAK TREE PROTECTION PLAN

A. Purpose

The purpose of this section is to 1) recognize the importance of native oak trees in preventing the erosion of hillsides and stream banks, moderating water temperatures in streams through shading, contributing nutrients to streams, supporting a wide variety of wildlife species through the provision of food, nesting, and roosting cover, and contributing to the scenic quality of the community; and 2) to provide for the protection of these trees.

B. Applicability

The provisions of this Section shall apply to native oak (*Quercus* species) trees, other than scrub oak, that have at least one trunk measuring six inches or more in diameter, or a combination of any two trunks measuring a total of eight inches or more in diameter. Trunks shall be measured at four and one-half feet above natural grade.

1. Supplemental Application Requirements

Grading Permit applications on sites containing oak trees subject to this Section shall include a tree protection plan, prepared by a qualified biologist or resource expert that provides:

- a.) An inventory and assessment of the health of native oak trees on the site that will be impacted by species, size (both trunk and crown diameter).
- b.) Photographs of the site showing areas where there are native trees that will be impacted.
- c.) A site map depicting the location of all such trees that will be impacted, including canopy location.
- d.) An analysis of all potential construction and post-construction impacts on the identified native trees (i.e. removed, damaged limbs, damaged trunk, damaged root system).
- e.) Identification of trees proposed to be removed by the project.
- f.) On-site mitigation measures necessary to minimize or mitigate residual impacts that cannot be avoided, including the provision of replacement trees.
- g.) A restoration plan for disturbed environmentally sensitive habitat.

2. Development Standards

- a.) Mitigation shall be required for the removal or damage of trees as described in this Section.

- b.) Structures, including roads or driveways, shall be sited to avoid to the maximum extent feasible encroachment into the protected zone¹ and to provide an adequate buffer outside of the protected zone of individual native oak trees being preserved on-site in order to allow for future growth, except where no other feasible alternative exists. If approved encroachments result in the death of the affected tree as a result of the proposed development, mitigation as described in this Section shall be required.
- c.) Drainage resulting from new construction shall be directed away from all root zones of all native trees.
- d.) Project Construction Measures
 1. Protective fencing shall be used around the outermost limits of the protected zones of the native trees within or adjacent to the construction area that may be disturbed during construction or grading activities. Before the commencement of any clearing, grading, or other construction activities, protective fencing shall be placed around each applicable tree. Fencing shall be maintained in place for the duration of all construction. No construction, grading, staging, or materials storage shall be allowed within the fenced exclusion areas, or within the protected zones of any on-site native trees. If any breach in the protective fencing occurs, all work in the immediate vicinity shall be suspended until the fence is repaired or replaced.
 2. Any approved landform modification activity, including grading or excavation that encroaches into the protected zone of a native tree, shall be undertaken using only handheld tools.
 3. Prior to issuance of the last Certificate of Occupancy in any planning area where there are impacts to oak trees, a qualified biologist shall conduct an on-site inspection of the planning area to ensure that no pre-existing native oak trees that are within or adjacent to the construction area have been removed or damaged by construction activities other than those identified in the original development application. If the biologist determines that any native oak trees have been removed (other than those approved by the original development permit) or damaged by construction activities, then additional mitigation may be required.
- e.) Mitigation shall be required for the project's impacts to environmentally sensitive habitat. Mitigation measures shall include on-site restoration to the maximum extent feasible.

¹ The protected zone of an oak tree, within which work activities are controlled, is defined as follows. Using the dripline as a point of reference, the protected zone commences at a point 5 feet outside of the dripline and extends inward to the trunk of the tree. In no case shall the protected zone be less than 15 feet from the trunk of an oak tree.

3. Mitigation

Adverse impacts to native trees shall be mitigated. Applicable development permits shall include the mitigation requirements as conditions of approval. Any oak tree species planted as part of an approved landscape plan, but not as mitigation for removal of a native oak tree, shall not be subject to mitigation if it is impacted at a later date.

Prior to the issuance of a grading permit that includes native oak tree removal or encroachment into the protected zone of native oak trees, the applicant shall submit a mitigation program (see “supplemental application requirements,” above), prepared by a qualified biologist, arborist, or other resource specialist, which specifies the number of replacement trees and their proposed approximate locations, and planting specifications.

Mitigation measures shall include the planting of replacement trees at suitable locations within the Specific Plan Amendment area at the following ratios for every oak tree meeting the preceding criteria that is removed. Trees that are relocated will not be subject to further mitigation, provided their survival rate is in compliance with the requirements for replacement trees. Where possible, the replacement trees shall be grown from stock that is adapted to climatic conditions similar to the Calimesa area.

Replacement Plantings	Trunk Diameter of Impacted Tree ¹					
	4” – 12”	12” – 18”	18” – 24”	24” -36”	36” – 48”	Over 48”
Acorn Groupings ^{1,4}	1	2	3	4	5	6
Total Acorns ^{2, 3, 4}	3	6	9	12	15	18
1 Gallon ^{2, 3}	2	4	6	8	10	12
5 Gallon ^{2, 3}	--	1	2	4	6	8
24” Box ⁵	--	--	1	2	3	4
36” Box ⁵	--	--	--	1	2	3
48” Box ⁵	--	--	--	--	--	1
Total plantings per impacted tree	5	11	18	27	36	46

Notes:

¹ As measured 4.5 feet above ground

² For locally grown stock, larger sizes can always be substituted for smaller sizes (up to five gallon). A one (1) gallon planting may be substituted for one grouping of acorns, and a five (5) gallon planting may be substituted for 2-one (1) gallon plantings or two groupings of acorns.

³ Acorns, one (1), and five (5) gallon materials will be used in oak woodland restoration areas on natural slope restoration areas and in the Nature Park.

⁴ Acorns will be planted in planting groups of three in accordance with specifications by LSA, resulting in one tree per locations after the first year.

⁵ Boxed material used in streetscape landscaping will count towards replacement credits.

VIII. GENERAL PLAN CONSISTENCY ANALYSIS

A. Overview

THE SUMMERWIND RANCH AT OAK VALLEY Specific Plan Area No. 1 Amendment No. 1 is based upon the goals and policies set forth in the Calimesa General Plan. This section addresses the conformance of SUMMERWIND RANCH AT OAK VALLEY to the City of Calimesa General Plan.

B. General Plan Elements

1. Land Use

- **Goal:** *Preserve and enhance the rural atmosphere and quality of life in Calimesa.*

Specific Plan Consistency: The proposed residential community will be enhanced with a rural character by providing over 1,500 acres of park and natural open space areas interspersed among the neighborhoods. The rural quality of life will also be established with the various trails that traverse the open space, of which will accommodate walking, biking, and horseback riding.

- **Goal:** *In order to preserve the quality of life, the character of the community, and to manage growth in Calimesa, allow development which is contiguous or close to existing development and in conjunction with the availability of infrastructure, public facilities and services.*

Specific Plan Consistency: The proposed commercial centers and business parks will be conveniently located at circulation nodes adjacent to Interstate 10 (I-10). In addition, future development is planned adjacent to the northerly boundary of the Specific Plan Amendment area, and to the south and southeast of the project site lies the Oak Valley Champions project in the City of Beaumont. Oak Valley Champions is a master planned golf-course community that will ultimately consist of a mix of open space, residential, golf course, and commercial uses. Varying densities of mobile homes and single-family residences are located adjacent to the eastern edge of SUMMERWIND RANCH AT OAK VALLEY and east of Interstate 10. Accordingly, various facilities and infrastructure will be provided adjacent to the project site.

- **Goal:** *Locate land uses to achieve maximum compatibility while improving or maintaining the desired quality of life.*

Specific Plan Consistency: The proposed development is designed to be compatible with the uses proposed to the north and south. Additionally, the residents of Calimesa will benefit from the conveniently located commercial goods and services to be provided by the Specific Plan Amendment.

- **Goal:** *Commercial and industrial developments shall be designed to serve the needs of Calimesa and the subregion.*

Specific Plan Consistency: SUMMERWIND RANCH AT OAK VALLEY will provide local and regional residents with 129.5 acres of commercial services located in the Town Center adjacent to the I-10 corridor.

- **Goal:** *Preserve the natural beauty, minimize degradation of the Calimesa area, and provide protection for environmentally sensitive resources.*

Specific Plan Consistency: The Specific Plan Amendment will preserve 1,493.1 acres of undeveloped land as open space and maintained community and neighborhood recreational areas. The preserved natural areas will consist of a variety of sensitive habitats including riparian woodland, wetland meadow, coastal sage scrub, and oak woodland. The preservation areas will be suitable for a variety of wildlife species native to the chaparral, grassland, coastal sage scrub, meadow, and riparian woodland ecosystems, including the 167 wildlife species observed on the property. The maintained open space will include the Calimesa Channel; Calimesa Creek; Garden Air Wash, and other intermittent stream channels extending west from north and central Calimesa; the Calimesa Golf and Country Club on the eastern portion of the City; the Southern California Edison easement along the southwest border of the City; and bikeways and trails through the north central portions of the City.

- **Goal:** *Ensure existing and future land uses have an adequate water supply system capable of meeting normal and emergency demands.*

Specific Plan Consistency: The Master Water Plan is designed to accommodate the SUMMERWIND RANCH AT OAK VALLEY community's domestic water demand. A domestic water demand study was conducted based on the Yucaipa Valley Water District (YVWD) Water Master Plan and Water System Design Criteria for New Development (Resolution No. 32-2002). The first phase of the project may be serviced by YVWD Zone R11 and by YVWD Zone R12. To service the higher portion of the site, a Sphere of Influence Change may be processed to allow for the use of planned facilities from the Beaumont-Cherry Valley Water District (BCVWD) in lieu of booster stations or additional off-site transmission mains. BCVWD Zone 2,520 may service the development portion within elevation 2,217 and 2,390 (ideal conditions) while B.C.V.W.D. Zone 2,650 may service the development portion within elevation 2,347 and 2,520 (ideal conditions). A portion of the Core Property consisting of 66.3 Acres of Residential (within Phase 5) and a 26.1 Acre Town Center Commercial parcel is not adjacent to the proposed BCVWD facilities and may be serviced by extending the YVWD facilities from Zone 12 to service the site. The Master Plan identifies the need for a new YVWD water filtration facility by 2006. The Yucaipa Valley Water District (YVWD) proposes to construct a 12 MGD Water Reclamation Facility on a 10.0 acre site within Village C.

- **Goal:** *Establish, extend, maintain and finance a safe and efficient wastewater collection, treatment and disposal system which maximizes treatment and water recharge, minimizes water use, and prevents groundwater contamination.*

Specific Plan Consistency: The Master Sewer Plan is based on the sewer study entitled *Preliminary Master Sewer Study*, and is included in the Appendices of the EIR for this project.

The sewer study is based on YVWD’s Wastewater Master Plan and Sewer System Design Criteria for New Development (Resolution No. 01-1998). The Sewer Plan YVWD is planning to expand the Live Oak Canyon treatment facility. This facility will serve existing and proposed development (2000 units) north of I-10 and a portion of SUMMERWIND RANCH AT OAK VALLEY. However, it will not have sufficient capacity to handle ultimate buildout of the Specific Plan Amendment. Consequently, sewerage from the first phases will need to be pumped northward via a combination of gravity lines and force mains. The YVWD proposes to construct a 12 MGD Water Reclamation Facility on a 10-acre site within Village C. The facility will be constructed and designed to receive wastewater from this project and other proposed projects. Discharge from this plant will connect into a proposed reclaimed water line to be built by Eastern Municipal Water District (EMWD). All facilities will be constructed via standard permit requirements, thus, groundwater contamination will be avoided.

- **Goal:** *In compliance with state law, ensure solid waste collection, siting and construction of transfer and/or disposal facilities, operation of waste reduction and recycling programs, and household hazardous waste disposal programs and education are consistent with the County Solid Waste Management Program.*

Specific Plan Consistency: The solid waste collector will be required to comply with state law and the County’s Solid Waste Management Program. Thus, the SUMMERWIND RANCH AT OAK VALLEY community will accommodate any disposal and waste reduction requirements imposed by the waste collector.

- **Goal:** *Ensure that adequate flood control facilities are provided prior to or concurrent with development, in order to protect the lives and property of Calimesa residents.*

Specific Plan Consistency: The overall drainage plan will be designed to perpetuate the natural drainage courses within the site. The on-site storm drains will outlet into the natural streambed areas and grading design will strive to minimize grading within the major streambed areas. Additionally, two detention basins will be provided in order to mitigate the majority of first flush flows from the site, prior to releasing them into San Timoteo Creek. All storm drain facilities will be designed in accordance with Riverside County Flood Control District (RCFC&WCD) guidelines and standards. Where needed, channel protection measures will be constructed in open areas to protect from excessive erosion.

- **Goal:** *Ensure the provision of adequate supplies of natural gas and electricity from public utility purveyors and the availability of communications services to residents of Calimesa, while protecting natural vistas and night skies.*

Specific Plan Consistency: Utility purveyors have provided will serve letters to the applicant of this development. The infrastructure needed to provide natural gas and electricity to the site is not expected to affect natural vistas and night skies.

- **Goal:** *Ensure, plan, and provide adequate infrastructure for all new development, including but not limited to, adequate planning, financing and implementation.*

Specific Plan Consistency: This Specific Plan Amendment document ensures that the adequate planning and infrastructure will be provided to the proposed development. Financing and implementation of the proposed development will be provided through satisfying permit requirements attached to individual Tentative Tract Maps.

- **Goal:** *Plan for the location of convenient and adequate public services, such as libraries, schools, and fire stations to serve the existing and future residents of Calimesa.*

Specific Plan Consistency: The proposed Specific Plan Amendment will provide three schools and a water reclamation facility. In addition, the Town Center Planning Area will provide a location for a Fire Station and library. The public utilities and infrastructure necessary to serve the proposed community will be conveniently located and phased in conjunction with development of the property.

- **Goal:** *Coordinate planning and development proposals with the affected school district to ensure that adequate school facilities and services can be provided in a timely manner.*

Specific Plan Consistency: Development of the three schools will be coordinated with the school district.

2. Transportation

- **Goal:** *Provide a balanced transportation system that ensures the safe and efficient movement of people and goods throughout the City while minimizing the use of land for transportation facilities.*
- **Goal:** *Develop a transportation system integrated with land use planning and responsive to the needs of the community.*
- **Goal:** *Seek to provide public transit services which promote the mobility of Calimesa residents and provide a reasonable alternative to the personal automobile.*
- **Goal:** *Regulate the travel of trucks on City streets.*
- **Goal:** *Develop measures which will reduce the number of vehicle-miles traveled during peak hour periods.*
- **Goal:** *Require adequate on-site parking to prevent spillover on the adjacent street system.*
- **Goal:** *Plan for and seek to establish an area-wide system of equestrian, hiking, and bicycling trails, with linkages to parks and the trail systems of adjacent jurisdictions.*
- **Goal:** *Establish vehicular access control policies in order to maintain and insure the effectiveness and capacity of arterials.*

- **Goal:** *Promote mobility for the disabled, in accordance with state and federal law.*

Specific Plan Consistency: During the preparation of the Environmental Impact Report (EIR), numerous technical studies will be completed to examine the potential impacts associated with development of SUMMERWIND RANCH AT OAK VALLEY. Summaries of these reports are contained in the EIR. An extensive project traffic analysis conducted by Urban Crossroads, Inc. has identified necessary and appropriate roadway improvements. Conditions of Approval will require the project to implement the improvements and contribute its fair share to facility development. The project would contribute an increment to cumulative impacts associated with intersections currently operating below Level of Service “C”. The project provides mitigation options to ameliorate impacts. In addition, a multi-purpose trail system is provided throughout SUMMERWIND RANCH AT OAK VALLEY.

3. Housing

- **Goal:** *Encourage the maintenance and rehabilitation of the existing housing stock.*

Specific Plan Consistency: This goal does not apply to the Specific Plan Amendment.

- **Goal:** *Promote housing access and equal opportunity for all persons regardless of race, religion, sex, marital status, ancestry, national origin, color or handicap.*

Specific Plan Consistency: The Specific Plan Amendment will provide a range of housing opportunities for all persons. It is illegal for lenders to discriminate against any potential home owner.

- **Goal:** *The City will work to provide opportunities for the development of new housing units to meet the housing needs of all economic segments of the population without disrupting the existing rural community feeling and without compromising environmental integrity.*

Specific Plan Consistency: The Specific Plan Amendment will provide a range of housing opportunities that meet the needs of a variety of economic segments of the population, while preserving sensitive biological resources contained in over 1,500 acres of open space and recreational areas within the Specific Plan.

- **Goal:** *Improve the housing supply and the choice of housing opportunities through private investment and, where necessary, through public assistance and financing.*

Specific Plan Consistency: The proposed Specific Plan Amendment improves the housing supply in the City by providing for 3,683 dwelling units – all of which will be developed by private investors.

4. Resource Management

- **Goal:** *Conserve and protect surface water, groundwater and imported water sources.*

Specific Plan Consistency: The overall drainage plan will be designed to perpetuate the natural drainage courses within the site. The proposed drainage system will utilize and incorporate natural channels into the ultimate storm drain system. On-site storm drains will outlet into the natural streambed areas and grading design will strive to minimize grading within the major streambed areas. The proposed project will not use or impact groundwater.

- **Goal:** *Conserve and protect significant landforms and hillside areas.*

Specific Plan Consistency: The SUMMERWIND RANCH AT OAK VALLEY land use plan demonstrates the concept of protecting sensitive natural areas by clustering residential neighborhoods. Clustering was used in the design concept so that significant ridgelines, drainages, valleys, oak trees, and wildlife corridors fall into the natural open space areas and are therefore protected.

- **Goal:** *Conserve and protect significant stands of mature trees, native vegetation, and wildlife habitat within the planning area.*

Specific Plan Consistency: The Specific Plan Amendment will preserve over 1,400 acres of undeveloped land as open space and maintained community and neighborhood recreational areas. The preserved natural areas will consist of a variety of sensitive habitats including riparian woodland, wetland meadow, coastal sage scrub, and oak woodland. The preservation areas will be suitable for a variety of wildlife species native to the chaparral, grassland, coastal sage scrub, meadow, and riparian woodland ecosystems, including the 167 wildlife species observed on the property. The maintained open space will include the Calimesa Channel; Calimesa Creek; Garden Air Wash, and other intermittent stream channels extending west from north and central Calimesa; the Calimesa Golf and Country Club on the eastern portion of the City; the Southern California Edison easement along the southwest border of the City; and bikeways and trails through the north central portions of the City. In addition, the project will implement an oak tree protection plan. This Specific Plan Amendment will also utilize the process of natural slope restoration. Slope restoration will balance structural needs for soil retention with the reestablishment of vegetation for surface cover and habitat restoration.

- **Goal:** *Promote cultural awareness through preservation of the City's historical, archaeological and paleontological resources.*

Specific Plan Consistency: During the preparation of the Environmental Impact Report (EIR), numerous technical studies will be completed to examine the potential impacts associated with development of SUMMERWIND RANCH AT OAK VALLEY. Summaries of these reports are contained in the EIR. An archeological and paleontological survey report has been completed to identify any archaeological, historical, or paleontological resources within the project site. These areas will be preserved and/or enhanced as necessary through required mitigation plans, and incorporated into planned land uses.

- **Goal:** *Conserve energy resources through the use of current energy conservation practices and technology.*

Specific Plan Consistency: Building energy conservation would be largely achieved by compliance with Title 20 of the Energy Conservation Code. Title 24, California Code of Regulations Section 2-5307(b) is the California Energy Conservation (CEC) Standard for New Buildings which prohibits the installation of fixtures unless the manufacturer has certified to the CEC compliance with the flow rate standards.

- **Goal:** *Conserve where appropriate, and avoid premature conversion of agricultural lands to urban development.*

Specific Plan Consistency: The Specific Plan Amendment area is currently undeveloped, with a small portion of land used for farming, agricultural, and rural residential land uses. Development of the Specific Plan Amendment would result in the removal of the agricultural uses. However, the existing, on-site agricultural productivity is not significant, and has not been an economic viable business for some time.

- **Goal:** *Seek to provide a network of open space areas to preserve natural resources and to provide visual and physical relief from urban development.*

Specific Plan Consistency: The Specific Plan Amendment will preserve over 1,400 acres of undeveloped land as open space, and maintained community and neighborhood recreational areas. The maintained open space will preserve aesthetically appealing features, such as the Calimesa Channel, Calimesa Creek, Garden Air Wash, and other intermittent stream channels extending west from north and central Calimesa, the Calimesa Golf and Country Club on the eastern portion of the City, the Southern California Edison easement along the southwest border of the City, and bikeways and trails through the north central portions of the City. In addition, the project will implement an oak tree protection plan. This Specific Plan Amendment will also utilize the process of natural slope restoration. Slope restoration will balance structural needs for soil retention with the reestablishment of vegetation for surface cover and habitat restoration.

- **Goal:** *Whenever possible, utilize less developable lands and existing public lands for parks and recreational uses in order to minimize costs.*

Specific Plan Consistency: This Specific Plan Amendment will preserve over 1,400 acres of natural open space and will provide 24 acres of recreational trails, including paseos, equestrian, and hiking trails utilizing existing trails wherever feasible. The proposed 89.6 acres of parks will include active, passive, linear parks, a nature park, and recreational facilities which will be developed by private entities; thus, the City will not incur any costs associated with their development.

- **Goal:** *Develop and maintain recreational facilities as economically feasible, and that meet the needs of all segments of the community for recreational activities, relaxation and social interaction.*

Specific Plan Consistency: The proposed parks and recreational facilities will be developed by private entities. Fees will be collected from the developer to pay for the maintenance of the recreational facilities. Thus, the City's economic burden of maintaining the parks would be minimized. The parks will be strategically located adjacent to schools to allow sharing of recreational and open space amenities. Additionally, the parks would serve the entire community by providing various features: basketball courts, baseball/softball diamonds, soccer fields, tot lots, parking areas, comfort stations, picnic areas, and passive use areas.

- **Goal:** *Actively pursue all available sources of financing for parkland acquisition and maintenance.*

Specific Plan Consistency: The proposed 89.6 acres of parks and recreational facilities will be developed by private entities; thus, the City will not need to incur costs associated with acquiring and maintaining them.

- **Goal:** *Utilize opportunities for joint use of public facilities for recreational purposes such as schools, flood control channels and land areas under the jurisdiction of other public agencies.*

Specific Plan Consistency: The parks will be strategically located adjacent to schools to allow sharing of recreational and open space amenities.

5. Safety

- **Goal:** *Minimize injury and loss of life, property damage, and other impacts caused by seismic shaking, fault rupture, ground failure, and landslides.*

Specific Plan Consistency: During grading and construction activities, the grading- and construction-related mitigation measures outlined in the Preliminary Geotechnical Report and EIR shall be implemented. Thus, impacts associated with seismic shaking, ground failure, and landslides will be avoided.

- **Goal:** *Minimize grading and otherwise changing the natural topography, while protecting the public safety and property from geologic hazards.*

Specific Plan Consistency: The proposed grading will be sensitive to and reflect the existing natural landforms. Additionally, sensitive environmental areas such as ridgelines, drainages and valleys, oak trees, and wildlife corridors will be preserved and incorporated into the design of parks and open space areas where ever possible. Thus, minimizing the amount of grading needed to develop the project. Additionally, the proposed project will avoid placing development in any areas containing geologic hazards.

- **Goal:** *Minimize injury, loss of life, property damage, and economic and social disruption caused by flood and inundation hazards.*

Specific Plan Consistency: The proposed project site does not contain a mapped 100-year floodplain or dam inundation area. Additionally, the grading design will strive to minimize

grading within the major streambed areas. All storm drain facilities will be designed in accordance with Riverside County Flood Control District (RCFC&WCD) guidelines and standards, and to accommodate 100-year storm flows. Where needed, channel protection measures will be constructed in open areas to protect from excessive erosion.

- **Goal:** *Reduce threats to public safety and protect property from wildland and urban fire hazards.*

Specific Plan Consistency: Fire hazards will be minimized with implementation of the proposed fuel modification on the landscaping plans for SUMMERWIND RANCH AT OAK VALLEY. Implementation of the plan will require that all plant types be approved by the Fire Department. Additionally, lots which cannot accommodate the 15’ setback requirement of Zone ‘A’ shall require a 1 hour rated fire wall.

- **Goal:** *Reduce the potential for hazardous waste contamination in the City.*

Specific Plan Consistency: If any of the proposed non-residential uses (the business park, commercial, schools, and water reclamation facility) handle, transport, or store hazardous wastes, a NPDES permit for operational activities would be required for those facilities that meet the classifications that are listed on the Regional Water Quality Control Boards’s Attachment 1 of the Industrial Activities Stormwater General Permit. That permit would require the business operator (permit holder) to develop an educational program for their employees that would inform them on ways to prevent illegal dumping and discharge of toxic detergents, oil and grease into the drainage system. Thus, the potential for hazardous waste contamination would be reduced.

- **Goal:** *Ensure to the fullest extent practical that, in the event of a major disaster, critical structures and facilities remain safe and functional.*

Specific Plan Consistency: The Yucaipa Valley Water District (YVWD) proposes to construct a 12 MGD Water Reclamation Facility on a 10-acre site within Planning Area C-7. The new sewage facility will require regulatory permitting, and will be constructed to remain operational during a major disaster.

- **Goal:** *Plan for emergency response and recovery from natural and urban disasters, especially from an earthquake threat.*

Specific Plan Consistency: Appropriate City agencies have prepared emergency preparedness plans that will provide officials with response measures during an earthquake event.

6. Noise

- **Goal:** *Ensure that all land uses are protected from excessive and unwanted noise.*

Specific Plan Consistency: An acoustical impact analysis has been prepared for the proposed development. The report provides measures, which will be implemented to mitigate noise impacts, primarily from traffic on surrounding roadways/highways. The proposed on-site uses (including the commercial uses) are not expected to generate excessive noise.

- **Goal:** *Work towards the reduction of noise impacts from vehicular traffic and trains.*

Specific Plan Consistency: The proposed Specific Plan Amendment provides alternative means of travel through the community (i.e. pedestrian, bicycle, and horse trails). Thus, the project will contribute to the reduction of vehicular-related noise in the area.

7. Air Quality

- **Goal:** *Promote alternative travel arrangements.*

Specific Plan Consistency: The proposed Specific Plan Amendment provides alternative means of travel through the community (i.e. pedestrian, bicycle, and horse trails).

- **Goal:** *Reduce emissions associated with vehicle use.*

Specific Plan Consistency: The proposed Specific Plan Amendment provides alternative means of travel through the community (i.e. pedestrian, bicycle, and horse trails). Thus, the project will contribute to the reduction of vehicular-related emissions in the area.

- **Goal:** *Reduce emissions associated with vehicle miles traveled by providing a balance of jobs and housing in the area.*

Specific Plan Consistency: The proposed Town Center will consist of a well-integrated mix of commercial, business park, and public facility land uses. The Town Center is centrally located within the site in an effort to promote pedestrian accessibility and a reduction in the amount of vehicle miles traveled, while also contributing to the local jobs/housing balance.

- **Goal:** *Reduce emissions associated with energy consumption.*

Specific Plan Consistency: Building energy conservation would be largely achieved by compliance with Title 20 of the Energy Conservation Code. Title 24, California Code of Regulations Section 2-5307(b) is the California Energy Conservation (CEC) Standard for New Buildings which prohibits the installation of fixtures unless the manufacturer has certified to the CEC compliance with the flow rate standards.

- **Goal:** *Reduce fugitive dust emissions.*

Specific Plan Consistency: Prior to issuance of grading permits, the project applicant/permittee shall submit an accelerated construction dust abatement management program to the City for approval. Additionally, prior to construction commencement, 90-day low-NOx tune-ups for off-road construction equipment will be required

- **Goal:** *Reduce air pollution emissions and impacts through siting and building design.*

Specific Plan Consistency: Building energy conservation would be largely achieved by compliance with Title 20 of the Energy Conservation Code. Title 24, California Code of Regulations Section 2-5307(b) is the California Energy Conservation (CEC) Standard for New Buildings which prohibits the installation of fixtures unless the manufacturer has certified to the CEC compliance with the flow rate standards.

- **Goal:** *Maximize the effectiveness of air quality control programs through coordination with other governmental agencies.*

Specific Plan Consistency: The City will cooperate with the SCAQMD to implement regional air quality strategies and tactics.

Impacts to environmentally sensitive habitat shall be mitigated in accordance with the Mitigation Monitoring and Reporting Program (MMRP) contained in the EIR for this Specific Plan Amendment. The MMRP includes specific measures for restoring some of the habitat on site. Required state (California Department of Fish & Game) and federal (U.S. Army Corps of Engineers) permits shall be issued prior to implementation of the restoration plan and issuance of grading permits.

4. Monitoring

The oak tree mitigation program will include appropriate monitoring requirements that specify the performance standards for on-site tree replacement to ensure that the replacement planting program is successful, including a specified monitoring period and performance standards for determining whether replacement trees are healthy and growing normally, and procedures for periodic monitoring and implementation of corrective measures in the event that the health of replacement trees declines during the monitoring period as specified below:

a.) Trees with Encroachment

Where approved development encroaches into the protected zone of native oak trees, a qualified biologist shall determine whether ongoing monitoring is needed to ensure that the encroachment has not damaged the native tree. If monitoring is determined to be needed, an appropriate period (not to exceed five years) for which each affected tree shall be monitored, based upon the extent of approved disturbance within the root zone, shall be established by the qualified biologist. An annual monitoring report shall be submitted for review by the City throughout the monitoring period specified in the monitoring plan. Should any of the trees be lost during the monitoring period as a result of the disturbance caused by the proposed development, the applicant will mitigate the impacts through the planting of replacement trees as required in this Section. If replacement plantings are required as mitigation, monitoring of the replacement trees shall be provided as required by this Section.

b.) Replacement Trees

Where the planting of replacement trees is required as mitigation and for trees which have been relocated, a qualified biologist shall, in addition to the construction report at the last occupancy permit within a phase, perform surveys of replacement trees, as described below.

- First year following installation: quarterly inspections with reports as needed if problems are developing. Annual report at end of the first year following installation.
- Second year: 6-month inspection and report as needed. Inspection and second annual report at end of second year.
- Third year: annual inspection and report.

- Fourth year: annual inspection and report.
- Fifth year: annual inspection and final report (if mitigation program has met the target performance goals).

The report shall be submitted for the review and approval of the City as required during the monitoring period. The monitoring report shall identify the size and health of replacement trees, comparing this information with the criteria provided in the native tree replacement planting program to determine whether the replacement trees are healthy and growing normally. Mid-course corrections shall be recommended and implemented as necessary. If performance standards are not met by the end of the required monitoring period, the monitoring period may be extended until the standards are met.

c.) Performance Standards

Establishment of the oak woodland mitigation program will be considered successful after the following criteria are met.

- 1.) Individual trees planted from acorns, deep one-gallon, or 15-gallon containers average a height of at least five feet.
- 2.) Replacement trees as a whole have a survival rate of no less than 60 percent following one year without irrigation. Should this criterion not be met, permanent irrigation may be provided as an alternative.
- 3.) Replacement trees are disease free.

Monitoring requirements for the on-site sensitive habitat restoration efforts will be detailed in the state and federal permits issued for the project.